

IAMU 2018

Annual General Assembly (AGA) of the International Association of Maritime Universities (IAMU)

17 - 19 October 2018, Barcelona, Spain

M. Grifoll, F.X. Martínez de Osés, M. Castells and A. Martín (Eds)



APDREJADO FRAGATA 74 CONONES

18
12H.



CONSTRUÏDO
POREL
MESTR
D'AIXA
JOSEP PERA
I FOU
CON PLANOS
DEL BARCO
SAN DOMINGO

FRAGATA :

ESLORA : 3,7 mts

MANGA : 0,6 m

PUNTA : 0,48 mts

EN EL EDIFICIO

Pla de Palau, 18
08003 Barcelona



UNIVERSITAT POLITÈCNICA DE
BARCELONA
Facultat de Ciències de l'Enginyeria

UNYB

**19th Annual General Assembly (AGA)
of the International Association of
Maritime Universities (IAMU)**

**Proceedings
Edited by:**

M. Grifoll, F.X. Martínez de Osés, M. Castells
and A. Martin

*Barcelona School of Nautical Studies
Universitat Politècnica de Catalunya (UPC – BarcelonaTech)*

**Barcelona, Spain
October 17-19, 2018**

M. Grifoll, F.X. Martínez de Osés, M. Castells and A. Martin (Eds)

A publication of:

**International Center for Numerical
Methods in Engineering (CIMNE)**
Barcelona, Spain



Printed by: Artes Gráficas Torres S.L., Huelva 9, 08940 Cornellà de Llobregat, Spain

© The Authors

ISBN: 978-84-947311-7-4

TABLE OF CONTENTS

| | |
|---------------------------------|-----|
| Preface | 7 |
| Acknowledgements | 9 |
| Organizers and Committees | 11 |
| SUMMARY..... | 13 |
| Contents | 15 |
| Proceedings | 19 |
| Authors Index | 461 |

PREFACE

This book contains the proceedings of the technical sessions of the *19th Annual General Assembly (AGA19)* of the *International Association of Maritime Universities (IAMU)*, held at the World Trade Center in Barcelona, Spain, the 17-19 October 2018.

Comprising all member universities, the AGA provides a unique forum for multilateral discussion of maritime issues. IAMU has held an AGA at one of its member universities every year since 2000.

The topic of this conference, as part of AGA19, was "Time for Action: A new thrust for the future of MET & Research" and the event encompassed activities in the framework to promote communication and exchange between members, interested maritime industry players and international organizations.

The conference was organized by the Barcelona School of Nautical Studies of the Universitat Politècnica de Catalunya – BarcelonaTech. Contributions to 19th AGA deal with the presentations of challenging tasks in the Electronics and Human Interface, Human Element, Maritime Education and Training, Maritime Environment, Maritime Policies and Issues, Ports and Terminal Management, Role of Women in the Maritime Industries, Safety and Security, Shipbuilding, Yachts, Shipping, Traffic Management, Navigation and Routing. The proceedings contained in this book were selected and reviewed by recognized experts of the international community. On behalf of the editors, sincere thanks are directed to the International Program Committee (IPC) and scientific reviewers listed on the next page.

The collection of full papers includes contributions from the authors and the editors cannot accept responsibility for any inaccuracies, comments and opinions contained in the text.

Barcelona, 1st of October 2018

Manel Grifoll, Marcel·la Castells, Xavier Martínez de Osès, Agustí Martín
Barcelona School of Nautical Studies
Universitat Politècnica de Catalunya – BarcelonaTech
Editors.

ACKNOWLEDGEMENTS



The Nippon Foundation



Barcelona School of Nautical Studies
of Polytechnic University of Catalonia -
BarcelonaTech



International Association of Maritime
Universities (IAMU)



Cambra de Comerç
de Barcelona

Cambra de Comerç de Barcelona



International Center for Numerical
Methods in Engineering (CIMNE)



Universitat Politècnica de Catalunya
(UPC)



Escola Europea Intermodal Transport



Barcelona Clúster Nàutic



Museu Marítim de Barcelona



Port de Barcelona

Port de Barcelona



PRACTICOS
DE BARCELONA

Prácticos de Barcelona

LOCAL EXECUTIVE COMMITTEE (LEC)

| | |
|-----------------------------|------------------------------------------------------------------------------------------------------------------------------------------------------------------------------------------------------------|
| Head: | Agustí Martín Barcelona School of Nautical Studies Polytechnic University of Catalonia |
| Deputy Head: | Manel Grifoll Barcelona School of Nautical Studies Polytechnic University of Catalonia |
| Administrative Committee | Anna Xalabarder Barcelona School of Nautical Studies Polytechnic University of Catalonia |
| Social Committee: | Juan Antonio Moreno Barcelona School of Nautical Studies Polytechnic University of Catalonia |
| Publications Committee | Marcel·la Castells Barcelona School of Nautical Studies Polytechnic University of Catalonia |
| Student Committee | Marc Nicolau Barcelona School of Nautical Studies Polytechnic University of Catalonia |
| Members | Clàudia Barahona, Mariano Badell, Xavier Calvo, German de Melo, Santi Ordás, Xavier Martínez, Jordi Torralbo Barcelona School of Nautical Studies Polytechnic University of Catalonia |

CONFERENCE SECRETARIAT

Mr Alessio Bazzanella

CIMNE Congress Bureau

Phone: +34 93 405 46 96

Fax: +34 93 205 83 47

Campus Nord UPC Ed. C3, Zona Comercial

Jordi Girona 1-3, 08034

Barcelona, Spain



<http://congress.cimne.com>

INTERNATIONAL PROGRAM COMMITTEE

Manel Grifoll (Program Editor)

FNB - Universitat Politècnica de Catalunya, Spain

Graham Benton

CSU Maritime Academy, California, USA

Marcel·la Castells

FNB - Universitat Politècnica de Catalunya, Spain

Nedko Dimitrov

Nikola Vaptsarov Naval Academy Varna, Bulgaria

Samrat Ghosh

Australian Maritime College, Australia

Thanassis Karlis

Australian Maritime College, Australia

Xavier Martínez de Osés

FNB - Universitat Politècnica de Catalunya, Spain

Matthew Rooks

Kobe University, Japan

Boris Svilicic

University of Rijeka, Faculty of Maritime Studies, Croatia

PROCEEDING REVIEWERS

Clàudia Barahona (FNB - UPC, Spain), Graham Benthon (CSU Maritime Academy, California, USA), Clara Borén (FNB - UPC, Spain), Marcel·la Castells (FNB - UPC, Spain), Nedko Dimitrov (Nikola Vaptsarov Naval Academy, Bulgaria), Rosa Mari Fernández (FNB - UPC, Spain), Shoji Fujimoto (Kobe University, Japan), Manel Grifoll (FNB - UPC, Spain), Samrat Ghosh (Australian Maritime College, Australia), Víctor Hugo Chacón (UMIP, Panamá), Thanassis Karlis (Australian Maritime College, Australia), Antoni Llull (FNB - UPC, Spain), Xavier Martínez García (FNB - UPC, Spain), Xavier Martínez de Osés (FNB - UPC, Spain), Germán de Melo (FNB - UPC, Spain), Takashi Miwa (Kobe University, Japan), Anna Mujal (FNB - UPC, Spain), Inma Ortigosa (FNB - UPC, Spain), Matthew Rooks (Kobe University, Japan), Ninna Roos (SAMK, Finland), Boris Svilicic (University of Rijeka, Croatia), Jordi Torralbo (FNB - UPC, Spain), Dang Van Uy (Vietnam Maritime University, Vietnam).

SUMMARY

| | |
|-------------------------------------------------|-----|
| Electronics and Human Interface | 21 |
| Maritime Education and Training | 37 |
| Maritime Environment..... | 222 |
| Ports and Terminal Management..... | 270 |
| Role of women in the maritime industries..... | 305 |
| Safety and Security | 335 |
| Shipbuilding, Marine Engineering..... | 352 |
| Shipping, Logistics and Traffic Management..... | 398 |
| Shipping, Navigation and Routing | 407 |
| AUTHORS INDEX | 461 |

CONTENTS

Electronics and Human Interface

| | |
|--------------------------------------------------------------------------------------------------------------------------|----|
| A framework for cyber security risk assessment of ships | 21 |
| <i>B. Svilicic, J. Celic, J. Kamahara and J. Bolmsten</i> | |
| The effect of flag state warning letters as a means of enforcing IMO rec. 263 on pilotage in the Danish straits | 29 |
| <i>P.M. Cossen</i> | |

Maritime Education and Training

| | |
|------------------------------------------------------------------------------------------------------------------------------------|-----|
| A Course Proposal for The Training of Marine Engineering Students about Alternative Fuels, Related Systems, and Operation | 37 |
| <i>B. Zincir and C. Deniz</i> | |
| Analyzing student feedback from the 2017 IAMU student forum: charting paths to the future | 46 |
| <i>A. Yang and M. J. Rooks</i> | |
| Case-studies based approach in maritime English teaching..... | 54 |
| <i>Z. Bezhanovi, T. Mikeladze, S. Rodinadze and K. Zarbazoia</i> | |
| Challenges in marine engineers training. goals and opportunities in the academic education on electric marine technology | 61 |
| <i>P. Casals-Torrens, R. Bosch, F. Díaz-Gonzalez, J. Nicolas and V. Fuses</i> | |
| Comparing Nautical BSc-Programs and their Quality Indicators | 71 |
| <i>T.E. Jensen and T. Resnes</i> | |
| Development of Maritime Education and Training through Human-ware Upgrading..... | 79 |
| <i>A. Abdel Hamid Kassar and A. Almalt</i> | |
| Educating the future maritime workforce in a sea of constant disrupters and change..... | 87 |
| <i>M. Alfultis</i> | |
| Enhanced Fast-Time-Simulation Features to support Ship-Handling Simulator Training | 94 |
| <i>K. Benedict, M. Kirchhoff, M. Schaub, G. Tuschling, M. Baldauf, M. Gehrke and M. Gluch</i> | |
| Factors that affect the delayed embarkation for and return from shipboard training of maap cadets | 113 |
| <i>D.A. Pedregosa, S. Akmad, B.D. Sodolski, L. Negapatan and G. De Guzman</i> | |
| Implementation of the ECDIS system: An OOW perspective as an integral part of educational improvement | 121 |
| <i>D. Brčić, S. Žuškin, S. Valčić and V. Frančić</i> | |
| Interactive root cause analysis (IRCA) as a practical tool for developing management skills (for masters in navigation)..... | 129 |
| <i>M. Chesnokova, O. Monastyrskaya and J. Monastyrskaya</i> | |

| | |
|----------------------------------------------------------------------------------------------------------------------------------|-----|
| Knowledge management at higher MET institutions | 137 |
| <i>V. Frančić, D. Zec, L. Maglić and I. Rudan</i> | |
| Maritime Training for Emergent Opportunities | 145 |
| <i>W. Nadolny</i> | |
| Paternalistic leadership in a distinctive maritime work environment: a study among maritime students | 150 |
| <i>E. Asyali and R. Allard</i> | |
| Rethinking STCW Education to Cope with Increased Autonomy and Autonomous Shipping | 158 |
| <i>J. Mogensen</i> | |
| Role of ECDIS training on improving situational awareness..... | 165 |
| <i>S.J. Cole and E. Asyali</i> | |
| Seafarers education, training and crewing in Ukraine..... | 173 |
| <i>M. Miyusov and V. Zakharchenko</i> | |
| The development of a qualification board to document engineering cadet performance as part of a training period at sea | 181 |
| <i>M.A. Cote</i> | |
| The IAMU-PAES-P project implementation benefits: the MAAP experience | 189 |
| <i>A. Baylon and E. Santos</i> | |
| To Enhance Enrollment of Female Cadets at Maritime Institutions And to Increase Women Seafarers in the Shipping Industry..... | 199 |
| <i>Qi Chen</i> | |
| Training engineers for remotely operated ships of the future..... | 207 |
| <i>G. Lokuketagoda, T. Miwa, S. Jayasinghe and D. Ranmuthugala</i> | |
| Using SCAT Analysis to Evaluate the Effects of Sailing Vessel Training on Emotional Quotient (EQ) Competencies | 215 |
| <i>Y. Kunieda, T. Yamagishi and K. Murai</i> | |

Maritime Environment

| | |
|------------------------------------------------------------------------------------------------------------------------------------------------------------|-----|
| A simulalation on transportation of suspended sediment due to the maintenance dredging of the CAI LAN international container terminal, Vietnam..... | 222 |
| <i>T.N. Nguyen Thi and H.G. Le Thi</i> | |
| An investigation into making ships cleaner and more energy efficient | 231 |
| <i>G. de Melo Rodríguez, R. P. Gueraçague and J.C. Murcia Gonzalez</i> | |
| Assessment of marine diesel engines performance based on carbon and nitrogen oxides content in exhaust gases..... | 242 |
| <i>V. Odintsov, D. Glazkov and N. Sviridyuk</i> | |
| Risk regional zonation of environmental pollution on the port of Hai Phong, Vietnam and the surrounding area | 250 |
| <i>L. Thi Huong Giang, N. Thi The Nguyen and N. Thanh Son</i> | |

| | |
|---------------------------------------------------------------------------------------------------------|-----|
| The Repelling Effect of Golden Apple Snail (<i>Pomacea canaliculata</i>) Egg Extract on Algae..... | 259 |
| <i>G. A. C. Casiano, H. P. T. Catalayban, C. M. Melliza, R. M. M. Parreño and V. L. Vecendario</i> | |

Ports and Terminal Management

| | |
|------------------------------------------------------------------------------|-----|
| Challenges and Opportunities for Enhancing Port Competitiveness in Africa .. | 270 |
| <i>A. S. Elselmy, A. M. Morsy and M. E. Abdel Aziz</i> | |

| | |
|---------------------------------------------------------------------------------------------|-----|
| Containership bay time and crane productivity: are they on the path of convergence?..... | 279 |
| <i>S. Yahalom and C. Guan</i> | |

| | |
|--------------------------------------------------------------------------------------------------------------------|-----|
| Open-berth structures' bed rock scour protection system from main propeller action: case study in Vietnam | 288 |
| <i>N. Thanh Son</i> | |

| | |
|---------------------------------------------------------------------------------------------------------------------|-----|
| Ship manoeuvre analysis and simulation to obtain scouring related propeller variables | 296 |
| <i>T. Llull, A. Mujal-Colilles, X. Gironella, M. Castells, X. Martíez de Osés, A. Martín and A. Sánchez-Arcilla</i> | |

Role of women in the maritime industries

| | |
|-------------------------------------------------------------------------------|-----|
| Barriers to Women's Leadership in Maritime and the Ways to Overcome Them. ... | 305 |
| <i>P. Ozdemir and T. Albayrak</i> | |

| | |
|--------------------------------------------------------------------------------------------------------------------------|-----|
| How can women be encouraged to work in maritime professions? - possibilities for flexible post-graduate studies | 314 |
| <i>N.M. Roos</i> | |

| | |
|-----------------------------------------------------------------------------------------------|-----|
| The evolution of female figures in met institutions over a decade: some case studies | 320 |
| <i>C. Barahona, M. Castells, S. Ordás and J. Torralbo</i> | |

| | |
|-----------------------------------------|-----|
| Women in the maritime industry | 329 |
| <i>A. Balasanyan and Z. Phutkaradze</i> | |

Safety and Security

| | |
|--------------------------------------------------------------------|-----|
| Assessment and management of risks in the industrial fishery | 335 |
| <i>S.S. Moyseenko and L.E. Meyler</i> | |

| | |
|----------------------------------------------------------------------------------------------------------------------|-----|
| Security analysis of the national maritime transport system as part of the maritime critical infrastructure | 344 |
| <i>N. Dimitrov, B. Mednikarov and V. Vasilev</i> | |

Shipbuilding, Marine Engineering

| | |
|----------------------------------------------------------------------------------------------------------------------------------|-----|
| Advances in the development of a computational model for analysis of ship navigation in brash ice | 352 |
| <i>J. García-Espinosa, B. Serván-Camas, J. Colom-Cobb and E. Oñate</i> | |
| An optimization of marine diesel engine operation parameters when using a mixed fuel (do and palm oil) as alternative fuel | 363 |
| <i>D. Van Uy, N. Dai An and N. Duc Hanh</i> | |
| Hybrid gas-electrical power & heavy duty propulsion. Test platform | 372 |
| <i>R. Bosch, P. Casals-Torrens and A. Serrano-Fontova</i> | |
| Research and manufacturing of high-mechanical copper alloys for shaft liners | 382 |
| <i>V. Anh Tuan, P. Mai Khanh, T. The Nam and N. Duong Nam</i> | |
| Study on the effect of changing hull resistances to turbochargers operations of marine diesel engine..... | 390 |
| <i>V.Q. Phan, N.K. Vu and C.A.T. Phan</i> | |

Shipping, Logistics and Traffic Management

| | |
|---------------------------------------------------------------|-----|
| Sea traffic management and the smart maritime community | 398 |
| <i>S. Velasquez Correa, X. Martinez de Oses and U. Siwe</i> | |

Shipping, Navigation and Routing

| | |
|---------------------------------------------------------------------------------------------------------------------------------|-----|
| Hunts point terminal market: the demand for waterborne-transportation as a part of the outbound distribution system..... | 407 |
| <i>S. Yahalom, C.-Q. Guan, E. Johansson and C. Kamga</i> | |
| Intercomparison of emissions assessment methodologies in a short sea shipping framework..... | 416 |
| <i>C. Borén, M. Castells and M. Grifoll</i> | |
| Investigation of grounding accidents in the bay of Izmir with the application of root-cause analysis | 425 |
| <i>A.C. Toz, C. Sakar and B. Koseoglu</i> | |
| Research on new obstacle avoidance algorithms for ships | 434 |
| <i>A. Lazarowska</i> | |
| The algorithm for fast forecasting of the collision danger degree with ships and surface objects in the e-navigation area | 442 |
| <i>A.N. Popov, A.I. Kondratiev and I.O. Smirnov</i> | |
| The application of mathematical models and simulations in the feasibility studies of ship manoeuvring | 450 |
| <i>T.S. Do, E. Hietbrink and C.V. Tran</i> | |

PROCEEDINGS

A FRAMEWORK FOR CYBER SECURITY RISK ASSESSMENT OF SHIPS

BORIS SVILIČIĆ^{*}, JASMIN ČELIĆ^{*}, JUNZO KAMAHARA[†] AND
JOHAN BOLMSTEN^{††}

^{*} Faculty of Maritime Studies
University of Rijeka
Studentska ulica 2, 51000 Rijeka, Croatia
e-mail: svilicic@pfri.hr, [https:// www.pfri.uniri.hr](https://www.pfri.uniri.hr)

[†] Graduate School of Maritime Sciences, Kobe University
5-1-1 Fukaeminami-machi, Higashinada-ku, Kobe, Japan
e-mail: kamahara@maritime.kobe-u.ac.jp, web page: [http:// www.maritime.kobe-u.ac.jp](http://www.maritime.kobe-u.ac.jp)

^{††} World Maritime University
Fiskehamnsgatan 1, 211 18, PO Box 500, SE-201 24, Malmö, Sweden
e-mail: johan.bolmsten@wmu.se, web page: <http://www.wmu.se>

Keywords: maritime traffic, maritime cyber risk management, ship cyber critical systems, cyber risk assessment, assessment framework.

Abstract. In maritime traffic, with the growing reliance on innovative ICT technologies, maritime cyber risk management to secure not only data, but as well as safe and reliable ship transport operations becomes increasingly important. This paper presents a framework for conducting general and comprehensive cyber risk assessment of ships to offer guidance for improving security level of cyber systems onboard ships. The assessment covers methods for identification of the both technical and administrative cyber threats and vulnerabilities, and relies on identification of ship cyber risk critical systems and assets. The vulnerability scanning and penetration testing as specific elements of ships cyber security assessment have been studied. The given methodology for cyber risk level determination is based on a qualitative approach to assessing risk.

1 INTRODUCTION

Ships are increasingly using information technology and operational technology systems that both rely on digitalization, integration, automation and networking. With growth in reliance on the information and communication technologies (ICT), there is a compelling necessity to develop mechanism and measures that allow not only data protection, but as well as safe ship operations [1-9]. Recently the International Maritime Organization (IMO) has published the

Guidelines on high-level recommendations for maritime cyber risk management [10]. While maritime regulations and policies currently do not adequately govern cyber security in the same way as other aspects of ships security and safety, cyber security risk assessment can be considered as being partly regulated by the IMO ISPS Code [11]. However, IMO has imposed to include maritime cyber risk management in the ISM Code safety management system on ships by 1st of January 2021 [12].

In this work, we present a framework for conducting cyber risk assessment of ships to offer guidance for improving security level of cyber systems onboard ships. As for ship uniqueness (in design, operations, cargo, operating environments...), the framework presented provides a method to balance appropriate cyber security mechanisms and measures by evaluating ship critical cyber systems and assets, key shipboard operations, existing safeguard controls, assessed cyber threats and vulnerabilities, and determined risk level.

2 CYBER RISK ASSESSMENT FRAMEWORK

A systematic cyber risk assessment is an essential part of the process for cyber security improvement of ships. Ship cyber risk assessment is a complex set of related and interdependent actions that intersect so as to provide safeguards that are effective and corresponding to challenges presented by ship critical systems specifics, ICT technologies evolution, and human resource capabilities. Cyber risk assessment relies upon determination of ship specific cyber risk factors to be assessed and relations among those factors. Results should provide identification of threats and vulnerabilities in the current deployment of ship critical systems and determination of likelihood and impact magnitude of their exposure caused not only by hardware or software, but also by implemented operational procedures and security policies.

The developed framework that relies on guidelines and practices [10-15] is shown on Figure 1. Framework consist of four main segments: (i) assessment preparation operations including ship critical systems identification, (ii) current cyber security assessment conduction and cyber risk determination, (iii) assessment results communication activities necessary for cyber security level improvement, and (iv) cyber risk assessment maintenance activities for ensuring efficiency. The proposed framework is not intended for initial assessment only, but also for periodic implementation to respond to rapid technological changes in a ship environment.

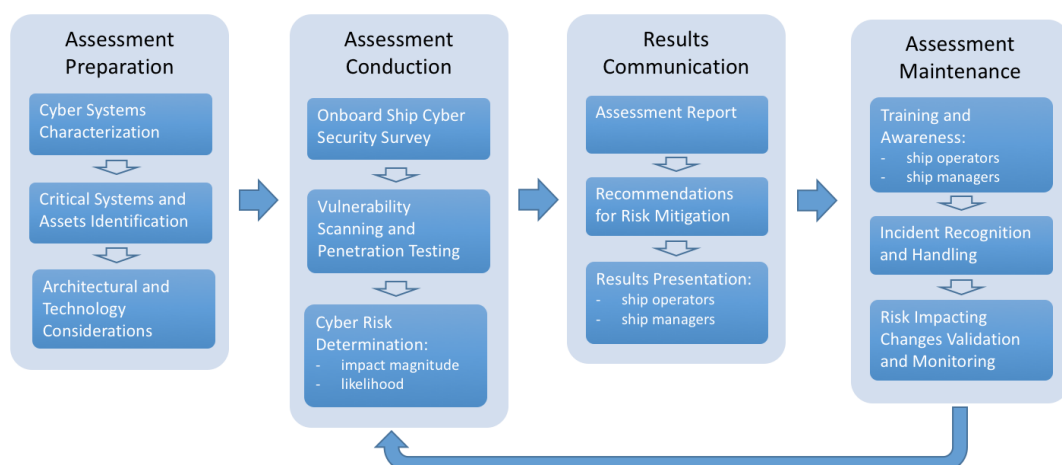

Figure 1: Proposed framework for cyber security risk assessment of ships

3 ASSESSMENT PREPARATION

The first phase to be performed as a part of the assessment is characterization of the ship cyber systems by gathering information about ship general technical specifications (type, layout of the ship, stowage arrangements plan...), identifying critical operations (cargo operations, crew/passenger exchange, bunkering...), identifying critical areas and personnel that may be targeted in cyber security incidents, and identifying possible types of motives for cyber security incidents (economical, political, symbolic, terroristic...). The outputs from the system characterization is basis for identification of ship cyber risk critical systems and assets. The Figure 2 shows general overview of ship cyber risk critical systems and assets.

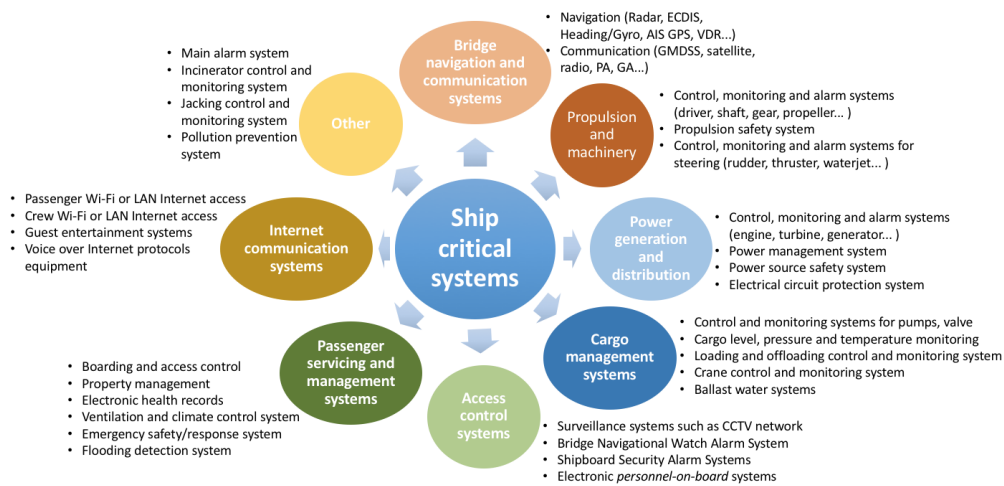

Figure 2: Ship cyber risk critical systems and assets

A comprehensive identification of the ship cyber risk critical systems and assets strongly depends on key shipboard operations being performed on a particular ship, such as navigation in high density traffic area, navigation in restricted visibility, heavy water operation, people accessing the ship... The next step is to consider the technological and architectural implications of the identified critical systems/assets on the cyber security, e.g. implemented network connections, operating systems, services, applications...

4 ASSESSMENT CONDUCTION

Onboard ship cyber security risk assessment conduction consists of three main actions: (i) onboard ship cyber security survey performing, (ii) vulnerability scanning and penetration testing, and (iii) cyber risk level determination.

4.1 Ship cyber security survey

The goal of performing and documenting the ship cyber security survey is to confirm that cyber security safeguard mechanisms and measures assumed to be in place and to identify non-existing and/or insufficient safeguard mechanisms and measures. To collect the relevant information, a questionnaire concerning the ship managers and operators is developed on the basis of the ship cyber risk critical systems and assets identified. The evaluation of current cyber security safeguard mechanisms and measures allow identification of eventual cyber threats and vulnerabilities. An example of a questionnaire for conducting the survey by interviewing the ship crew is given in Table 1.

Table 1: Example of cyber threats and vulnerabilities survey

| Critical System | Assets | Threats | Vulnerabilities |
|-----------------------------------------------------------------------|------------------------------------------------------------------------------------------------------|------------------------------------------------------------------------------------------------------------------------------------------------------------------------------------------------------------------------------|---------------------------------------------------------------------------------------------------------------------------------------------------------------------------------------------------------------|
| Cyber security management system | Policies and procedures | - Policies and procedures related to cyber security are developed - Policies and procedures are communicated to the all crew... | - Roles and responsibilities are not clearly defined - Incidents detection, analysis and response... |
| | Incident handling and response management | - All information security incidents are reported - Mechanism to monitor and quantify incidents is identified... | - Roles and responsibilities are not clearly defined - Incidents detection, analysis and response... |
| Bridge Systems | ECDIS | ... - Communication security - Software security... | ... - Connections to the Internet is established - Operating system and applications are patched... |
| | ARPA | - Cyber incident handling procedures are in place - Handling of portable devices... | - Incidents detection, analysis and response - Enforcement of security status of USB media... |
| Propulsion and machinery management systems and power control systems | Control and monitoring system Alarm system | ... - Access controls are in place - Authentication controls are in place... - Audit and logs are in place... - Procedure for authorized access... | ... - All accesses are provided to authorized personnel only - All control mechanisms are enforced... - Security-relevant events are recorded and kept - Log-out obligation is enforced... |
| Cargo management systems | Remote control and alarm systems for pumps Conditioning, temperature, ventilation system of cargo | ... - Remote authentication controls are in place - Physical access is provided to authorized personnel only... - Policies and procedures are reviewed periodically - Training before actual use of a program... | ... - Remote authentication by using cryptographic only - All default passwords have been changed... - Incidents detection, analysis and response - Physical and environmental protection... |
| Passenger servicing and management systems | Ventilation and climate control system Flooding detection system | ... - Access control policy - Fail-over procedures - Policy for authorized access - Training on security safeguards... | ... - Documentation of authorized users and privileges - Redundant architecture and backup systems... - Password sharing and common accounts are forbidden - Incident recognition and handling... |
| Internet communication systems | Firewall Anti-virus software | ... - Network privacy protection - Latest patches or new releases are implemented... - Malicious code protection mechanisms are implemented - Latest virus definitions or new releases are implemented... | ... - Firewall designs, rules and policies - Central management and reporting... - Malicious software infections - Central management and reporting... |
| ... | ... | ... | ... |

4.2 Vulnerability scanning and penetration testing

Compared to other types of ship assessment [15], the most specific element of the cyber security risk assessment is conduction of vulnerability scanning and penetration testing. The vulnerability scanning is a process of reviewing critical systems and assets to locate and identify known weaknesses. As a step beyond, penetration testing is a systematic employment of legal and authorized attempts to exploit target system/asset in order to prove that a cyber risk exists. Therefore, in this work, vulnerability assessment is considered as an phase utilized to complete a process of penetration testing. Process for conducting vulnerability scanning and penetration testing (Figure 3) starts with gathering all relevant information about the target system. This phase relies on the data collected by the survey, which should be enhanced with technical documentation of the target system. The second phase of the process begins by breaking the model preparation for effective scanning and testing into three distinct steps: (i) determining turned-on and communicable target systems, (ii) identifying active ports and services on the target system, and (iii) obtaining appropriate credential to gain access to the targeted system.

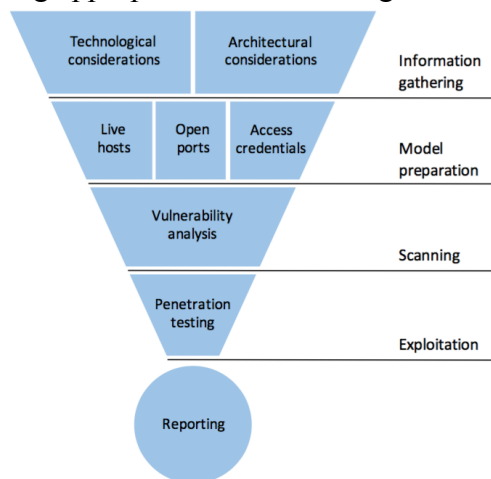

Figure 3: Process for conducting vulnerability scanning and penetration testing

Vulnerability scanning and penetration testing, the third and fourth phases, in information systems generally is mainly conducted using commercial tools (Table 2). The main advantage is ability to scan a large number of hosts for common vulnerabilities and exposures. However, the process is limited to only detecting vulnerabilities and exposures for which the vendor of the tool used has released plugins. In addition, as the tool vendor has no knowledge of a ship critical systems and assets specifics, the results could incorrectly reflect the real risk.

Table 2: Vulnerability scanner (VS) and penetration (PT) test software tools

| Name | Type | License | Operating System |
|-------------|---------|-------------|------------------|
| Nessus | VS & PT | Proprietary | Cross-platform |
| Kali | VS & PT | GPL | Linux |
| ImmuniWeb | VS & PT | Proprietary | MS Windows |
| Netsparker | VS & PT | Proprietary | MS Windows |
| Acunetix | VS | Proprietary | Cross-platform |
| Nexpose | VS & PT | GPL | Cross-platform |
| Core Impact | VS & PT | Proprietary | MS Windows |
| OpenVAS | VS | GPL | Linux |
| Retina | VS | GPL | MS Windows |

4.3 Cyber risk determination

On the basis of the assessment results, cyber risk analysis is performed to identify and categorized cyber threats to which an ship is exposed. The qualitative risk analysis is performed by evaluating the impact magnitude and likelihood of various threats determined that could exploit vulnerabilities to harm cyber security of critical systems and assets. The method provides a relatively simple, but satisfactory bases for the cyber risk analysis. The threats likelihood is a rating of the probability that a vulnerability is exploited. The likelihood levels are given as low, medium and high with given values of 0.1, 0.5 and 1, respectively (Figure 5). The impact refers to the magnitude of a harm resulting from successful exploitation of a vulnerability. The impact magnitude rates are high, medium and low with given values of 100, 50 and 10, respectively.

| | | | |
|----------------|---------------------------|---------------------------|------------------------------|
| High (100) | Medium-risk level (10) | High-risk level (50) | Critical-risk level (100) |
| Medium (50) | Low-risk level (5) | Medium-risk level (25) | High-risk level (50) |
| Low (10) | Low-risk level (1) | Low-risk level (5) | Medium-risk level (10) |
| | Low (0.1) | Medium (0.5) | High (1) |

Figure 4: Example of risk-level matrix for qualitative risk analysis of cyber threats

Cyber risk level is calculated by multiplying the threat likelihood ratings by the impact magnitude of the vulnerability exploited. The given result indicates qualitative risk level: (i) critical-risk level requiring immediate action, (ii) high-risk level requiring remediation implementation plan, (iii) medium-risk level which may be acceptable over the short period of time, and (iv) acceptable low-risk level.

5 RESULTS COMMUNICATION AND ASSESSMENT MAINTENANCE

The final steps in the cyber risk assessment process are the results communication and assessment maintenance. The assessment results communication phase produces assessment reports that describes cyber threats and vulnerabilities, qualitative risk level determined and recommendations for implementation of safeguard controls to mitigate the cyber risks. The report is to ensure that each recommendation is addressed with specific, realistic, and tangible actions. The recommendations should contain information to support appropriate decisions on ship policies, procedures, operational impact and feasibility. Because a cyber risk can never be completely eliminated, recommendations for the risk mitigation must be acceptable by a cost-benefit analysis, resulting in a least-cost solution with minimal adverse impact on the ship critical systems and assets. The assessment report is presented to the ship managers and operators to improve the cyber security level.

The whole ship's crew cyber security awareness and training have a significant impact on detecting cyber security incidents and preventing cyber security compromises in general. So, it is considered as a part of the assessment maintenance phase. The whole ship's crew has the obligation to be aware of their responsibilities in protecting the critical systems and assets from compromise. In addition, ship crew training is also a tool that can increase ship's crew awareness and capabilities in recognition and handling of cyber security incidents. Incidents prioritization is very important for successful response process and is conducted on the basis of the determined risk-level matrix (Figure 4). During incident handling, communication with external parties is required (vendors, law enforcement, media...), so communication guidelines are predetermined to share only appropriate information with the right parties.

Once the cyber security risk assessment of a ship has been completed and recommendations for the risks mitigation are initiated, the achieved risk impacting changes are validated and monitored. The validation and monitoring processes basically include the activities covered with the assessment conduction phase (onboard ship cyber security survey, vulnerability scanning and penetration testing, and the risk determination) resulting in updated recommendations for risk mitigation. Therefore, the cyber security management requires continuous commitment, evaluation and improvement of the safeguard controls to mitigate the cyber risks.

6 CONCLUSIONS

A general and comprehensive framework for conducting cyber risk assessment of ships is presented. The assessment covers methods for identification of the cyber threats and vulnerabilities caused by installed hardware or software, as well as by implemented security policies and operational procedures. The assessment relies on the identification of ship cyber critical systems and assets that strongly depend on key shipboard operations being performed on a particular ship. As a part of the process for the identification of cyber threats and vulnerabilities, a questionnaire for conducting the survey by interviewing the ship crew to evaluate current implementation of cyber security safeguard mechanisms and measures is presented. In addition, the vulnerability scanning and penetration testing, as a specific element of ship cyber security risk assessment, are studied. The qualitative cyber risk analysis based on the of risk-level matrix is proposed. The presented study provides guidelines for mitigating the cyber risks and to improve the cyber security level of ships.

ACKNOWLEDGMENTS

The research was financially supported by the Faculty of Maritime Studies University of Rijeka under the research project Internet of Maritime Things and Cyber Security.

REFERENCES

- [1] Lee, Y.C., Park, S.K., Lee, W.K. and Kang, J. Improving cyber security awareness in maritime transport: A way forward. *Journal of the Korean Society of Marine Engineering*. Korea: Korean Society of Marine Engineering, 2017, 41 (8), 738-745. ISSN 2234-7925.
- [2] Sviličić, B., and Kraš, A. Computer Systems Privacy Protection. *Journal of Maritime Research Pomorstvo*. Rijeka: University of Rijeka Faculty of Maritime Studies, 2005, 19

- (2), 275-284. ISSN: 1332-0718.
- [3] Hassani, V., Crasta, N. and Pascoal, A.M. Cyber security issues in navigation systems of marine vessels from a control perspective. In: *Proceedings of the International Conference on Offshore Mechanics and Arctic Engineering - OMAE*. New York City: American Society of Mechanical Engineers, 2017, pp. 1-6. ISBN: 978-079185774-8.
- [4] Polatid, N., Pavlidis, M. and Mouratidis, H. Cyber-attack path discovery in a dynamic supply chain maritime risk management system. *Computer Standards and Interfaces*. Amsterdam: Elsevier B.V., 2018, 59, 74–82. ISSN: 09205489.
- [5] Hareide, O.S., Jøsok, Ø., Lund, M.S, Ostnes, R. and Helkala, K. Enhancing Navigator Competence by Demonstrating Maritime Cyber Security. *Journal of Navigation*. Cambridge: Cambridge University Press, 2018, in press. ISSN: 03734633.
- [6] Shapiro, L.R., Maras, M.-H., Velotti, L., Pickman, S., Wei, H.-L. and Till, R. Cyber-attack path discovery in a dynamic supply chain maritime risk management system. *Journal of Transportation Security*. New York: Springer, May 2018, 8, 1–19. ISSN: 19387741.
- [7] Botunac, I. and Gržan, M. Analysis of software threats to the automatic identification system. *Brodogradnja*. Zagreb: Brodarski, May 2018, 68 (1), 97–105. ISSN: 0007215X.
- [8] Burton, J. Cyber attacks and maritime situational awareness: Evidence from Japan and Taiwan. In: *Proceedings of the 2016 International Conference on Cyber Situational Awareness, Data Analytics and Assessment*. New Jersey: Institute of Electrical and Electronics Engineers Inc., 2016, pp. 1-4. ISBN: 978-150900703-5.
- [9] Balduzzi, M., Pasta, A. and Wilhoit, K. A security evaluation of AIS automated identification system. In: *Proceedings of the 30th Annual Computer Security Applications Conference*. USA: Association for Computing Machinery, 2014, pp. 436-445. ISBN: 978-1-4503-3005-3.
- [10] International Maritime Organization. MSC-FAL.1/Circ.3: Guidelines on maritime cyber risk management. London: IMO, 2017
- [11] International Maritime Organization. SOLAS/CONF.5/34: International Ship and Port Facility Security (ISPS) Code. London: IMO, 2013
- [12] International Maritime Organization. MSC 98/23/Add.1: Maritime Cyber Risk Management in Safety Management Systems. London: IMO, 2017
- [13] National Institute of Standards and Technology. Framework for Improving Critical Infrastructure Cybersecurity. Gaithersburg: NIST, 2014
- [14] The European Maritime Safety Agency, M. Mylly. High Level Conference on Cyber Security in Civil Aviation: Cyber Risks in Maritime Community. Krakow: EMSA, 2017
- [15] DNV GL. DNVGL-RP-0496: Cyber security resilience management for ships and mobile offshore units in operation. Oslo: DNV-GL, 2016
- [16] Ernstsen, J. and Nazir, S. Consistency in the development of performance assessment methods in the maritime domain. *WMU Journal of Maritime Affairs*. New York: Springer, 2018, 17, 71–90. ISSN: 1651-436X.

THE EFFECT OF FLAG STATE WARNING LETTERS AS A MEANS OF ENFORCING IMO REC. 263 ON PILOTAGE IN THE DANISH STRAIGHTS

PHILIP MAX COSSEN, MASTER MARINER, LLM

Svendborg International Maritime Academy (SIMAC)

Graaesvej 27, DK-5700 Svendborg, Denmark

e-mail: pmc@simac.dk, <http://www.simac.dk/en/frontpage/>

Keywords: Pilotage, IMO Recommendation, UNCLOS, Innocent Passage, Flag state warnings

Abstract: A ship operator wishing to transit the Danish Straights faces two options. He may choose to adhere to IMO's recommendation to take a pilot and spend up to US \$11,000 (DanPilot) each way, or he may instruct his master to navigate through these complex waters in dense traffic and varying depths and face the consequences of being reported to his flag state by the Danish Maritime Authority (DMA). In principle, either choice is legal. This paper bases its research upon statistical data presented by the Danish Maritime Authority (DMA) combined with post-graduate research data generated via interviews of major stakeholders engaged in the maintenance of safe marine traffic through the Danish Straights. The Paris Memorandum of Understanding on Port State Control (Paris MoU) database (Thetis) has been analyzed against flag state warning letters issued by the DMA to ships not adhering to the IMO recommendation SN.1/Circ.263 in 2017. The DMA data consists of statistical data on the name, nationality and type of ships transiting various stretches of Route T between 2013 and 2017. The DMA data analyses the interrelationship between nationality, owner, type of ship and contraventions to the IMO Recommendation. The purpose of this analysis was to ascertain whether the flag state letters had triggered an additional PSC inspection.

Preliminary results indicate that ship owners opting not to adhere to the IMO recommendation face no immediate legal or financial consequences whatsoever.

1. INTRODUCTION

The number of vessels adhering to IMO Recommendation SN.1/Circular 263 to engage a pilot when transiting Route T or the Sound through Danish waters has decreased steadily during the past five years. Route T starting at Skaw in the northernmost part of Denmark and ending in Gedser at the southernmost part is regarded as one of the busiest shipping lanes in

the world. Vessels transiting through the Sound between Sweden and Denmark navigate through dense traffic with ferries crossing the narrow, 2 nm wide straight. An average of 27,000 vessels each year entering or leaving the Baltic Sea transit one of the Danish Straights. In 2017, 325 of these were deep draught vessels with a draught exceeding 11 meters. The increase in traffic is partly due to the Russian Government's extension of the trans-Russian pipelines to St. Petersburg on the Baltic Sea (Wandel, J, 2017). DanPilot, which is the largest supplier of pilots in the Danish Straights, estimates that 800,000 tons of oil outbound from the Baltic port of Primorsk is piloted through Danish waters each day.

Route T and the Sound are regarded as challenging passages for navigators due to a series of sharp bends, dense traffic and shoals. Despite these factors, no mandatory pilotage regulations exist. This is due to the UNCLOS right to innocent passage combined with the Copenhagen Treaty of 1857, which both leave the decision to engage a pilot to the prerogative of the ship master. In recognition of the huge environmental impact that a polluting incident would have in the Danish Straights, the IMO has published an official recommendation, Circular 263, (IMO, 23.10.2007) in which all deep draught ships are recommended to engage a pilot when transiting Route T and the Sound. In an attempt to enforce this IMO Recommendation, the DMA issues flag state warning letters to the flag state of any vessel failing to adhere to the Recommendation. The number of flag state warning letters increases annually as the number of non-piloted vessels decreases.

2. RESEARCH METHODS

The paper aggregates qualitative data gathered by the DMA combined with results from an existing research paper (Mathias Bjørn Ørsted Christensen, 2018). In this research paper, the Paris Memorandum of Understanding on Port State Control (Paris MoU) database (Thetis) was analyzed against flag state warning letters issued by the DMA to ships not adhering to the IMO Recommendation in 2017. The DMA data consists of statistical data on the name, nationality and type of ships transiting various stretches of Route T between 2013 and 2017. The DMA data analyses the interrelationship between nationality, owner, type of ship and contraventions to the IMO Recommendation. Using this data, a search in the Thetis database was undertaken for every violating ship that was issued a flag state warning letter in 2017. The purpose of this analysis was to ascertain whether the flag state letters had triggered an additional PSC inspection.

3. REGULATION

In order to understand the decision the master faces when opting not to engage a pilot, we must attempt to understand the background of maritime law which regulates the waters surrounding Route T and the Sound.

The doctrine that the sea by its nature must be free to all has always been a long standing tradition. In recognition of this fact a coastal state is allowed to exercise only limited jurisdiction in the waters adjacent to its shores. Initially, the area of jurisdiction was confined to a cannon-shot range creating a belt along the entirety of its coast. In the late 18th century this concept was replaced by a fixed limit of 3 nautical miles. In the course of legal development many nations have now standardized their jurisdiction to 12 nautical miles which coincides with the maximum allowable limit of Article 3 in UNCLOS (The United Nations Convention on the Law of the Sea). UNCLOS which was adopted in 1958, contains the most widely recognized set of international rules regulating the rights of the coastal state in matters regarding protection of its waters and natural resources.

A fundamental cornerstone of UNCLOS is the right to Innocent Passage (Article 17), which allows a ship or aircraft the right to enter and pass through the territorial waters of another state so long as the passage complies with the Article 19 definition: *“Passage is innocent so long as it is not prejudicial to the peace, good order or security of the coastal State.”*

In other words, no fishing, spying, polluting, transfer of cargo, persons or illegal trade of any nature whatsoever may be conducted in the territorial waters of a foreign nation. The right of Innocent Passage of foreign ships through the territorial waters of a coastal state is one of the oldest and most universally recognized rules of public international law.

Any attempt at imposing mandatory pilotage in Route T or the Sound would thus constitute an infringement of the right to Innocent Passage and in conflict with UNCLOS. Those unfamiliar with this area of international law may consider this an unreasonable restriction on the options available to a coastal state wishing to protect its waters from, drunken masters, pollution or hazards to navigation.

As a matter of fact, UNCLOS allows for the right to Innocent Passage to be overruled by the coastal state if the deems necessary due to the above mentioned risks. Article 21 states that:

“The coastal State may adopt laws and regulations, in conformity with the provisions of this Convention and other rules of international law, relating to innocent passage through the territorial sea, in respect of all or any of the following: “... (a) the safety of navigation and the regulation of maritime traffic; ... (f) the preservation of the environment of the coastal State and the prevention, reduction and control of pollution thereof.”

Additional other safety and environmentally related factors are mentioned in Article 21.

Reading Article 21, most people would agree that the DMA have the necessary jurisdiction to regulate the movement of vessels transiting the Danish Straights based on the interest of the safety of navigation and or/the preservation of the marine environment, and thus *can* impose mandatory pilotage in order to protect their waters.

This assumption is quite understandable and a widespread misconception. Article 35 imposes an irrevocable stalemate situation on the flexibility introduced under Article 21 by stating that:

“Nothing in this Part affects: (c) the legal regime in straits in which passage is regulated in whole or in part by long-standing international conventions in force specifically relating to such straits”.

Such a *long-standing international convention* has existed in Danish waters since the enactment of the Copenhagen Convention of 1857 Abolishing Tolls and Mandatory Pilotage in Danish Waters (Hugo Caminos, 2014). The Convention abolished three centuries of mandatory dues forced upon all foreign vessels transiting any of the Danish Straights. Failure to pay the dues, which were calculated as a percentage of the value of the cargo, led to the sinking or confiscation of the ship and/or her cargo. The Copenhagen Convention of 1857 thus made the Danish Straights international waterways free to all military and commercial shipping. The convention forbids mandatory pilotage or tolls and expressly states that the decision to take a pilot rests solely with the ship’s captain or owner. Pilot fees must be:

“...moderate and equal to foreign as well as national vessels” (Article 3 Copenhagen Convention 1857).

The above restrictions set upon the DMA’s authority to impose mandatory pilotage ultimately led to IMO Recommendation SN.1/Circ.263 December 2003: *Amendments to the recommendation on navigation through the entrances to the Baltic Sea* in which pilotage is recommended:

Route T

3. Ships with a draught of 11 metres or more... and

4. Ships irrespective of size or draught, carrying a shipment of irradiated nuclear fuel, plutonium and high level radioactive wastes on board ships (INF-Code materials) should:

.1 use for the passage the pilotage services locally established by the coastal States;

The Sound

Loaded oil tankers with a draught of 7 metres or more, loaded chemical tankers and gas carriers, irrespective of size, and ships carrying a shipment of irradiated nuclear fuel, plutonium and high level radioactive wastes (INF-Code materials), when navigating the Sound... should:

.I use the pilotage services established by the Governments of Denmark and Sweden;

With its' hands tied, the DMA attempts to enforce IMO Recommendation SN.1/Circ.263, by issuing so-called flag state warning letters to the flag states of all vessels navigating through the Danish Straights in violation of this Recommendation (Mortensen, 2014). The desired effect of these warnings is to persuade the flag state authority to take disciplinary action against the owner or operator of a violating ship in its flag register.

4. FLAG STATE WARNING LETTERS AND PORT STATE CONTROL

Having established that the Danish Government does not have the legal authority to impose mandatory pilotage on vessels transiting the Danish Straights, this paper will now consider how the DMA's flag state letters of warning draws violating ships to the attention of Port State Control (PSC) inspectors.

Under the regime of the Paris MoU, a vessel reported to another member state for violating IMO Recommendation 263 is upgraded to a Priority II ship. This reporting process, which takes place via the Danish Maritime Assistance Services (MAS) is defined as an Unexpected Factor within the realms of Paris MoU. This Unexpected Factor upgrades the ship to a Priority II ship and which can trigger an additional PSC inspection in the next Paris MoU port. The need to undertake an additional inspection is however for the professional judgement of the PSC Authority (MoU, Paris).

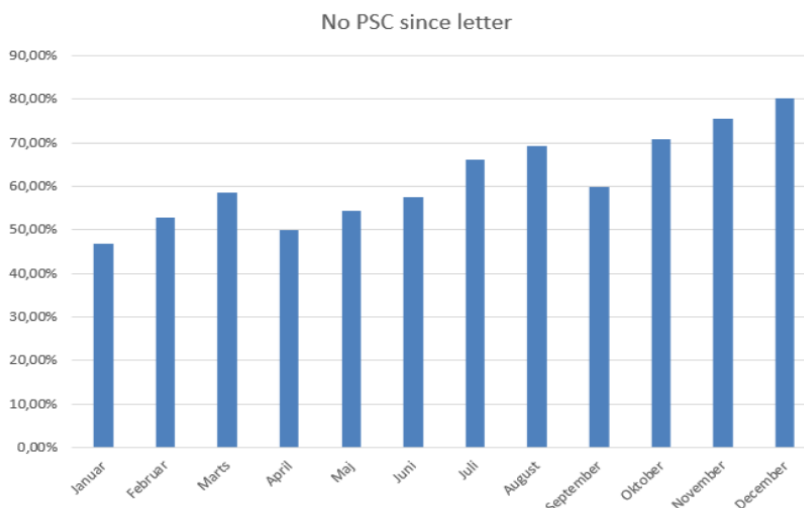

Figure 1: Illustrates the percentage of ships in 2017 that did NOT undergo a PSC inspection following issuance of a Flag State Letter. (Christensen, Jakobsen and Juhl, 2018)

Results of analytical research (Christensen, Jakobsen and Juhl, 2018) concluded that there was next to no evidence that PSC inspections were conducted as a direct result of the flag state

letters. Furthermore, there was conclusive evidence, that the more recent the issuance of the flag state letter, the more unlikely it was that an additional PSC inspection would occur. Instead, vessels were selected for inspection through the standard selection criteria and ship risk profiles.

5. DATA ANALYSIS

This section will provide a brief consolidated analysis of the qualitative data gathered by the DMA. The intensity of heavy traffic entering and leaving the Baltic through the Danish Straights has increased steadily during the last decade. Since 2013, the number of vessels encompassed by IMO's Recommendation to take a pilot in the Danish Straights has increased by 20% and yet the actual number of vessels taking a pilot in 2017 fell from 3282 to 2732. The DMA data on violating vessels and flag state letters revealed that 654 letters were issued in 2017. This is an increase of 174% since 2013 where only 239 letters were issued.

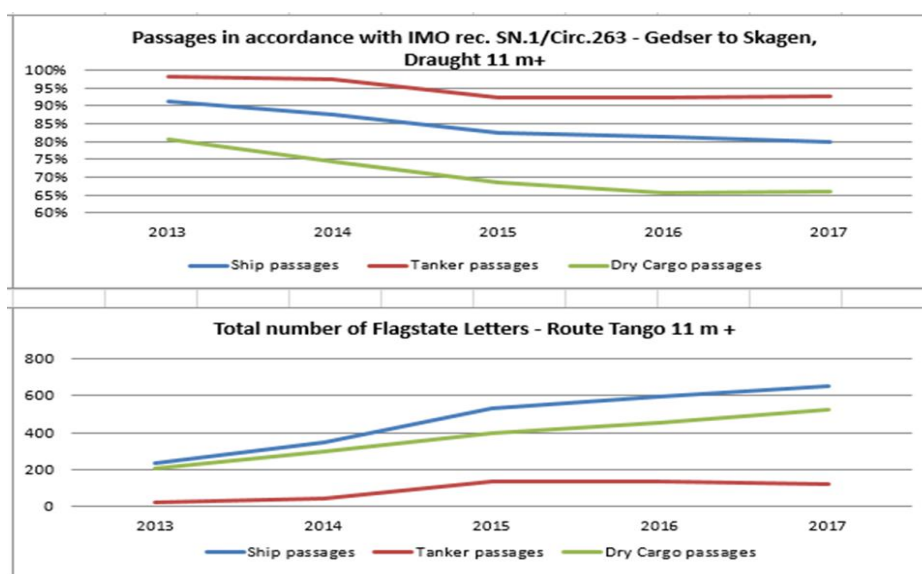

Figure 2. Danish Maritime Authority: Transits of Route Tango 2013 to 2017 (Hansen, S, 2018)

The number of vessels transiting Route T that were encompassed by the IMO Recommendation also increased steadily from 2732 ships in 2013 to 3251 in 2017. Interestingly, the number of vessels not adhering to the Recommendation has seen a greater increase in comparison to the number of transiting ships, see Figure 2.

Data analysis revealed that the majority of ship owners still choose to take a pilot for part of the transit, but opt to save costs by not taking a pilot for the entire 278 nautical mile transit of Route T as per the IMO Recommendation, see Figure 3. Instead, vessels now transit long stretches of Route T unassisted by local pilot knowledge. In what appears to be systematic compliance with

company instructions not to engage a pilot, one Greek tanker owner/operator chose not to take a pilot 23 times in 2014 (Andersen, O. 2014).

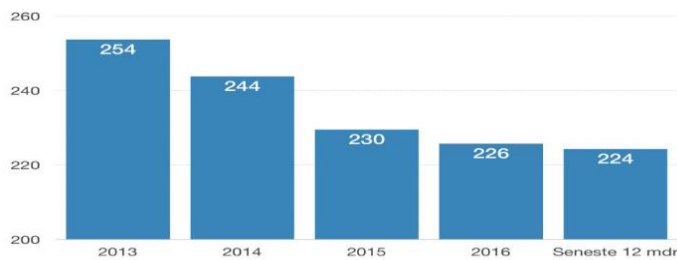

Figure 3. Danish Maritime Authority: Average distance per ship with a pilot through Route T in nautical miles 2013 - 2017 (Hansen, S, 2018)

Further analysis revealed that 81% of the 652 flag state warning letters issued to deep draught vessels in 2017 were issued to dry bulk vessels and 19% to tankers. This is due to oil major requirements and restrictive charter party clauses making pilotage compulsory for ship operators. Of the flag state warning letters issued, 20.1% went to Panama, 16.9% to Greece, 15.3% to Liberia, 13% to the Marshall Islands, 8.6% to Hong Kong and 7.8% to Malta. Interestingly, all of the violating flag states are on the latest Paris MoU White list published in June 2016, (2016 Paris MoU performance list, June 2017). From this, it can be concluded that the issuance of the flag state warning letters does not have a detrimental effect on the overall PSC performance of violating flag states.

6. CONCLUSION

Research on the effects of flag state warning letters issued to the flag states of vessels violating IMO Rec. 263 when transiting the Danish Straights can conclude that the intention of flag state warning letters appears to have little effect. This has been verified by the fact that there is an increase in the number of flag state letters issued to the same ship owners despite the fact that their flag states receive recurring warning letters. Furthermore, the increase in issued warning letters is proportionally greater than the increase in traffic indicating that more vessels choose not to take a pilot for the whole of Route T. The option available to PSC inspectors to conduct an additional PSC inspection is not systematically utilized within the Paris MoU regime and therefore fails to pose a threat of sanctions upon the ship operators. Finally, there is an increase in ships taking a pilot for considerably shorter stretches of Route T than recommended by IMO Rec. 263.

All of the above results lead to the conclusion that the warning letters issued by the Danish Maritime Authority have little effect on the enforcement of IMO Recommendation 263.

The question remaining to be answered is therefore: Is the financial benefit gained by ship owners and charterers opting not to take a pilot through the Danish Straights counterbalanced by the overriding risk and consequences of a marine disaster?

REFERENCES

- DanPilot.** DanPilot Rate Calculator. *DanPilot*. [Online] [Cited: May 14, 2018.] <http://www.danpilot.dk/en/rate-calculator>.
- Hansen, S. 2018.** Pilotage Statistics by Danish Maritime Authority. [Online] January 2018. [Cited: March 23, 2018.] [http://us.lodstilsyn.dk/514/statistics-\(new\)](http://us.lodstilsyn.dk/514/statistics-(new)).
- Hugo Caminos, Vincent P. Cogliati-Bantz. 2014.** *The Legal Regime of Straights, Contemporary challenges and solution*. s.l. : University of Queensland. Publisher: Cambridge University Press., 2014.
- IMO. 23.10.2007.** *IMO Recommendation SN.1/Circular. 263 of 23.10.2007, section 1.9 and 1.14, in MSC 138 (76)*. 23.10.2007.
- Mathias Bjørn Ørsted Christensen, Nikolaj Munk Jakobsen, Mathias Juhl. 2018.** *Absence of a pilot in Route Tango, The preventative effects of flag state letters in the light of PSC. (Title translated from Danish)*. s.l. : SIMAC, 2018.
- Mortensen, Lise Høj. 2014.** Cooperation on IMO pilot recommendations at risk (Title translated from Danish). [Online] January 28, 2014. [Cited: April 06, 2018.] <http://www.soefartens.org/nyheder/2014/1/samarbejde-om-imo-lodsanbefalinger-i-fare.aspx>.
- MoU, Paris.** Paris MoU on PSC Memorandum Amendment 40 Annex 8, sect. 8 (online. *Paris MoU*. [Online] [Cited: May 08, 2018.] https://www.parismou.org/system/files/Paris%20MoU%2C%20including%2040th%20amendment_0.pdf.
- UN. 10 December 1982.** *United Nations Convention on the Law of the Sea*. s.l. : UN, 10 December 1982.
- Wandel, J. 2017.** Sticky as asphalt and smells like tar, (Title translated from Danish). *Søfartens Ledere*. [Online] October 2017. [Cited: April 08, 2018.] <https://soefartensledere.dk/2017/10/03/1955/>.

A COURSE PROPOSAL FOR THE TRAINING OF MARINE ENGINEERING STUDENTS ABOUT ALTERNATIVE FUELS, RELATED SYSTEMS, AND OPERATION

B. ZINCIR* AND C. DENIZ*

* Istanbul Technical University Maritime Faculty
Postane Mah., Sahil Cad., 34940, Tuzla – Istanbul, Turkey
e-mail: bzincir@itu.edu.tr, denizc@itu.edu.tr

Keywords: Alternative Fuel, Course Proposal, Engine Officer

Abstract. Sea trade is an important element of international trade. There are huge number of ships at worldwide, and they emit huge amount of emissions accordingly. Stricter emission regulations are entered into force, and will be entered into force in the future by the International Maritime Organization and EU to control and reduce these emissions. To comply with these regulations, alternative fuels are in use. The alternative fuelled ship number is in increase. Despite the alternative fuel usage at maritime industry increases, there are not any alternative fuel courses at the maritime universities to educate the marine engineering students. In this study, a new course about the alternative fuels, their related systems, and operation is proposed for the training of the marine engineering students. Competences at the STCW amendments for the persons who work on alternative fuelled ships are taken into account while preparing the course topics. Each topic is paired with basic and advanced training competences of the STCW amendments, and compliance with the STCW is provided. Lastly, the course topics and sub-topics are explained for the guidance to prepare the alternative fuel course.

1 INTRODUCTION

Sea trade forms the major part of international trade. It is done with 90.917 merchant ships in various size and tonnages [1]. This high number of ships mean huge amount of fuel consumption and emission formation related to the fuel consumption. According to International Maritime Organization (IMO), global annual fuel consumption from all ships was 300 million tons [2]. Again, IMO stated that the shipboard NO_x emission was 19 million tons, the SO_x emission was 10.2 million tons, the CO₂ emission was 949 million tons, the CO emission was 936 thousand tons, and the PM emission was 1.4 million tons in 2012. The emission amounts enforce IMO and local authorities to make emission rules and regulations more stringent. Lower NO_x emission limits, less sulphur in fuel, and new CO₂ emission control and reduction strategies like MRV Regulation or IMO Data Collection System are measures to prevent higher emission amounts.

To cope with the stringent emission rules and regulations, ship owners and operators have to use emission abatement technologies or alternative fuels at their ships. Usage of the alternative fuels on ships increases in number. Liquefied natural gas (LNG), liquefied petroleum gas (LPG), and methanol is in lead at the use of the alternative fuels on ships. There are 116 LNG fuelled ships, 12 LPG fuelled ships, and 2 methanol fuelled ships in operation [3]. Alternative fuelled fleet will increase with new buildings.

IMO pays attention to the progress at the alternative fuel usage at maritime industry. In this framework, The Code of Safety Using Gases or Other Low-Flashpoint Fuels (IGF Code) was adopted, and entered into force on and after 1 January 2017 [4]. By this code, some amendments were made to Chapter II-1 and Chapter II-2 of the International Convention for the Safety of Life at Sea (SOLAS) which were also entered into force on and after 1 January 2017 [5]. Other important amendments were made to the International Convention on Standards of Training, Certification and Watch keeping for Seafarers, 1978 (STCW), and entered into force on same date with other relevant conventions.

Nowadays, education about the alternative fuels increases its importance. There are some examples for the courses in worldwide for land-based facilities and vehicles. Veer Surendra Sai University of Technology has the course named Internal Combustion Engine & Gas Turbines which includes the alternative fuels in its course plan [6]. Another course is the “Alternative Fuel” which is given at The Hong Kong Polytechnic University [7]. There is only one postgraduate program at World Maritime University (WMU), which includes the alternative fuels & renewable energy [8], but this is also not a course that contains whole aspects of the STCW.

Recent developments in both technology and legislation bring necessity of education of the ratings and especially the officers about the alternative fuels, shipboard alternative fuel systems, and operation. Maritime universities have important place in officer training, and should adapt themselves to the developments in the maritime industry. This study aims to propose a new course to give adequate knowledge to the marine engineering students about the alternative fuels, fuel systems, and the operation with the alternative fuels. For this purpose, competences part of the basic and advanced training of STCW amendments is taken as a reference. Knowledge, understanding and proficiency part related to the competences are examined in detail. A course syllabus is formed, and the course topics are explained.

2 STCW AMENDMENTS RELATED TO THE ALTERNATIVE FUELLED SHIPS

STCW has the amendments to the Chapter VI – Special training requirements for personnel on certain types of ship. New section, A-V/3 – Mandatory minimum requirements for the training and qualification of masters, officers, ratings and other personnel on ships subject to the IGF Code was added. The amendments include the basic and advanced training and qualification requirements for the ratings and the officers [9]. Table 1 shows the competences of the basic and advanced training. The basic training is for ratings, and the basic and advanced training is for officers.

Table 1: Competences of the basic and advanced training [9]

| BASIC TRAINING |
|-------------------------------------------------------------------------------------------------------------------------------------------------|
| - Contribute to the safe operation of a ship subject to the IGF Code |
| - Take precautions to prevent hazards on a ship subject to the IGF Code |
| - Apply occupational health and safety precautions and measures |
| - Carry out firefighting operations on a ship subject to the IGF Code |
| - Respond to emergencies |
| - Take precautions to prevent pollution of the environment from the release of fuels found on ships subject to the IGF Code |
| ADVANCED TRAINING |
| - Familiarity with physical and chemical properties of fuels aboard ships subject to the IGF Code |
| - Operate controls of fuel related to propulsion plant and engineering systems and services and safety devices on ships subject to the IGF Code |
| - Ability to safely perform and monitor all operations related to the fuels used on board ships subject to the IGF Code |
| - Plan and monitor safe bunkering, stowage and securing of the fuel on board ships subject to the IGF Code |
| - Take precautions to prevent pollution of environment from the release of fuels from ships subject to the IGF Code |
| - Monitor and control compliance with legislative requirements |
| - Take precautions to prevent hazards |
| - Apply occupational health and safety precautions and measures on board a ship subject to the IGF Code |
| - Knowledge of the prevention, control and firefighting and extinguishing systems on board ships subject to the IGF Code |

3 FORMATION OF THE COURSE STRUCTURE

This section includes proposed topics which were determined according to the competences at the STCW amendments. After the determination of the topics, these topics were explained in detail with their sub-topics, and the course structure was formed.

3.1 Determination of the course topics

The course topics were determined by taking into consideration of the basic and advanced training competences (Column 1) and their knowledge, understanding and proficiency (Column 2) section in the STCW amendments. But, due to the page number limits, only the competences were shown in this study. According to the STCW amendments, seven main topics with their sub-topics were determined. Table 2 shows the topics for the new alternative fuel course, and Table 3 shows matching of the STCW amendment competences with the proposed course topics.

Table 2: Proposed Course Topics

| |
|---------------------------------------------------------------------------------------|
| T1 – INTRODUCTION TO THE ALTERNATIVE FUELS |
| - Shipping Emissions |
| - Emission Abatement Technologies and the Alternative Fuels |
| - Maritime Industry Developments Related to the Alternative Fuels |
| T2 – ALTERNATIVE FUEL RULES AND REGULATIONS |
| - International Maritime Organization Rules and Regulations |
| - Class Society Rules and Guidelines |
| - Other Guidelines and Standards |
| T3 – PROPERTIES OF THE ALTERNATIVE FUELS |
| - Physical Properties of the Alternative Fuels |
| - Chemical Properties of the Alternative Fuels |
| - Special Properties Related to the Alternative Fuel Type |
| - Health Effect of the Alternative Fuels |
| T4 – FUEL AND STORAGE SYSTEMS OF THE ALTERNATIVE FUELS |
| - Tank Line and Equipments |
| - Fuel Supply Line and Equipments |
| - Main Engine and Auxiliary Engine Line and Equipments |
| - Safety Systems of the Alternative Fuels |
| T5 – OPERATIONS WITH THE ALTERNATIVE FUELS |
| - Bunkering Operations |
| - Onboard Tank Transfer Operations |
| - Storage and Handling Operations |
| - Other Onboard Operations |
| T6 – RISKS AND HAZARDS |
| - Risk Assessment About the Alternative Fuels and the Systems |
| - Hazard Control |
| - Safety Management and ISM Documentation About the Alternative Fuels and the Systems |
| T7 – EMERGENCY SITUATIONS |
| - First-aid |
| - Fire |
| - Leakage/Spillage/Venting |
| - Emergency Shutdowns, Emergency Escape Routes and Equipments |
| - Special Emergency Situations Related to the Properties of the Alternative Fuels |

Table 3: Matching of the competencies with the proposed course topics

| Basic Training | Notations of the Proposed Course Topics | Advanced Training | Notations of the Proposed Course Topics |
|---------------------------------------------------------------------------------------------------------------------------|-----------------------------------------|-----------------------------------------------------------------------------------------------------------------------------------------------|-----------------------------------------|
| Contribute to the safe operation of a ship subject to the IGF Code | T1 / T3 / T4 / T5 | Familiarity with physical and chemical properties of fuels aboard ships subject to the IGF Code | T1/ T3 |
| Take precautions to prevent hazards on a ship subject to the IGF Code | T3 / T5 / T6 | Operate controls of fuel related to propulsion plant and engineering systems and services and safety devices on ships subject to the IGF Code | T4 / T5 |
| Apply occupational health and safety precautions and measures | T2 / T3 / T5 / T7 | Ability to safely perform and monitor all operations related to the fuels used on board ships subject to the IGF Code | T4 / T5 |
| Carry out firefighting operations on a ship subject to the IGF Code | T7 | Plan and monitor safe bunkering, stowage and securing of the fuel on board ships subject to the IGF Code | T4 / T5 / T7 |
| Respond to emergencies | T7 | Take precautions to prevent pollution of environment from the release of fuels from ships subject to the IGF Code | T3 / T6 / T7 |
| Take precautions to prevent pollution of the environment from the release of fuels found on ships subject to the IGF Code | T7 | Monitor and control compliance with legislative requirements | T2 |
| | | Take precautions to prevent hazards | T5 / T6 / T7 |
| | | Apply occupational health and safety precautions and measures on board a ship subject to the IGF Code | T3 / T5 / T7 |
| | | Knowledge of the prevention, control and firefighting and extinguishing systems on board ships subject to the IGF Code | T7 |

3.2 Explanation of the course topics

This section mentions about the basic contents of the each course topic. The contents were determined according to the competences of the STCW amendments.

T1 – Introduction to the Alternative Fuels

This topic is the introduction topic to the alternative fuel course. It is formed by the sub-topics of “Shipping emissions”, “Emission abatement technologies and the alternative fuels”, and “Maritime industry developments related to the alternative fuels”.

Shipping emissions sub-topic gives information about the shipping emission types, how they form, effect of combustion on the different emission types, and annual amount of shipping emissions. Emission abatement technologies and the alternative fuels sub-topic mentions about the emission abatement technologies, for instance exhaust gas recirculation system, selective catalytic reactor, SO_x scrubbers etc., for the different emission types. In addition to this, effect of the alternative fuels on the emissions is included in this sub-topic. Last sub-topic of this main topic gives information about the alternative fuels which have been used on ships until now, and other maritime industry related information as bunkering capabilities, engine concepts etc.

T2 – Alternative Fuel Rules and Regulations

This topic is composed by the sub-topics of “International Maritime Organization rules and regulations”, “Class society rules and regulations”, and “Other guidelines and standards”.

All sub-topics aim to give general information about the rules and regulations which determine the minimum standards of the structural requirements of the ships, and the operation necessities for the alternative fuels. This topic gives awareness about the rules and the regulations about the alternative fuels which is a requirement of the STCW amendments.

T3 – Properties of the Alternative Fuels

“Physical properties of the alternative fuels”, “Chemical properties of the alternative fuels”, “Special properties related to the alternative fuel type”, and “Health effect of the alternative fuels” are the sub-topics of this main topic. Material Safety Data Sheet information of the alternative fuels can be used to discuss properties in this topic.

Physical properties sub-topic gives necessary information about the properties of the alternative fuels, for instance, flashpoint, auto-ignition temperature, other important temperatures for storage, handling and transfer of the alternative fuels, combustion properties, viscosity etc. Chemical properties sub-topic includes reactivity properties of the alternative fuels. Ship materials which can react with the used alternative fuel should be explained in this sub-topic. Special properties related to the alternative fuels are explained, for example, frost, corrosive substance, special expansion – shrinkage at certain temperature etc. Last sub-topic is about health effect of the alternative fuels. Threshold values of daily exposure rates should be discussed, and necessity of protective clothing and equipment should be mentioned.

T4 – Fuel and Storage Systems of the Alternative Fuels

This topic is formed by the sub-topics of “Tank line and equipments”, “Fuel supply line and equipments”, “Main engine and auxiliary engine line and equipments”, and “Safety systems of the alternative fuels”.

Storage tanks of the alternative fuels are important element in the whole system. There are cooled and pressurized types and various shaped tanks for the ships. For this reason, the tank line and the equipments should be discussed in a separate sub-topic. Fuel supply lines also have low-pressure lines and high-pressure lines depend on the used system type, and valve, pump and other line elements which change with the line type. Main engine and auxiliary engine line and equipments also should be mentioned for the marine engineering students. There are additional piping, pumping and other elements depend on fuel type, system type etc. Safety systems of the alternative fuels are also important subject. It is indicated as one of the competences in the STCW amendments. This sub-topic should include double-walled pipe safety systems, fans, emergency stops, tank safety systems, gas measurement systems and alarms, and other related safety equipments.

T5 – Operations with the Alternative Fuels

“Bunkering operations”, “Onboard tank transfer operations”, “Storage and handling operations”, and “Other onboard operations” sub-topics constitute the main topic. Liquid cargo handling simulator or engine room simulators, which use alternative fuel as a fuel at main engine and auxiliary engines can be used at this section.

Bunkering operations sub-topic, mention about the bunkering procedures of the specified alternative fuels. Special precautions should be taken for the different alternative fuel type. Thus, bunkering checklists should be discussed in this sub-topic. Onboard tank transfer procedures should be mentioned at another sub-topic. Specified transfer precautions and important points of the operations should be discussed. Storage and handling operations are other important points while doing voyage. For this reason, storage and handling procedures for each operation should be discussed. These operations can be drying, inerting, purging, cooling down, stripping, draining, boiling off or rollover for gaseous fuels [5]. It can be organized for liquid alternative fuels too. The last but not the least sub-topic for this main topic is “Other onboard operations”. Other operations means that they do not related with the alternative fuels, but done on an alternative fuelled ship. These operations can be hot work, enclosed spaces and tank entry etc. Safe working knowledge for every operation should be explained in detail at this main topic.

T6 – Risks and Hazards

This topic includes “Risk assessment about the alternative fuels and the systems”, “Hazard control”, and “Safety management and ISM documentation about the alternative fuels and the systems”.

Risk and hazards should be mentioned at the risk assessment sub-topic. There can be various hazards related to the alternative fuels. These are health hazards, environmental

hazards, reactivity hazards, corrosion hazards, ignition, explosion and flammability hazards, electrostatic hazards, toxicity, sources of ignition, vapor leaks and clouds, extremely low temperatures, pressure, fuel batch differences and inert gas composition [9]. After that, basic risk assessment techniques should be explained, and class works should be done with the marine engineering students. The hazard control actions of above mentioned hazards should be stated at the “Hazard control” sub-topic. Safety management and ISM requirements should be introduced to the students to eliminate the lack at the paperwork knowledge.

T7 – Emergency Situations

This topic contains “First-aid”, “Fire”, “Leakage/Spillage/Venting”, “Emergency shutdowns, emergency escape routes and equipments”, and “Special emergency situations related to the properties of the alternative fuels” sub-topics.

At this section of the course, more advanced first-aid and fire fighting knowledge should be given to the students by taking into consideration of the properties of the specific alternative fuels. Additionally, practical fire fighting training also improves the skill of the students. Leakage/Spillage/Venting sub-topic is another important subject. Students should know how to react and how to act at these situations. Emergency shutdowns, emergency escape routes and equipments are also important things to know, when it is the worst case, and you have to leave the ship. Lastly, there are special properties of the alternative fuels, and special emergency situations can occur, for instance, extreme corrosion-reactivity, explosion, electrostatic materials, toxicity, extremely low temperatures etc. These emergency situations should be mentioned at the last sub-topic of this main topic.

12 CONCLUSIONS

This study is about improving marine engineering education by proposing a new course for alternative fuels, their related systems and operation. Firstly, STCW amendments for the alternative fuels were examined, and the competences and knowledge requirement columns of the basic training and advanced training were taken into consideration. The course topics were determined according to the competences and the knowledge requirements. Each competence was matched by the topics, so the course can cover all competence requirements of the basic and advanced training. At the last part of the study, the course topics were explained in detail.

The alternative fuel usage at the maritime industry is in increasing trend. It will be expected that more ships in number will use various type of alternative fuels in the future. Therefore, the maritime universities should be prepared to give the education about the alternative fuels to their marine engineering students. There are different types of alternative fuels with different properties, thus the marine engineering students have to learn the properties of the alternative fuels, the tank and fuel systems of them and the operations with them. This study aims both to give awareness and form a guideline to the maritime universities. It can be small pathway for the further discussions of the alternative fuel related courses at the maritime universities.

REFERENCES

- [1] United Nations Conference on Trade and Development (UNCTAD). Review of Maritime Transport 2016, 2016
- [2] International Maritime Organization. Third IMO Greenhouse Gas Study 2014, 2015
- [3] Zincir, B. and Deniz, C. Maritime Industry Developments Related to Alternative Fuels. In: *Proceedings INT-NAM 2018, 3rd International Naval Architecture and Maritime Symposium*. Turkey: Yildiz Technical University, 2018, pp.893-905.
- [4] International Maritime Organization. Resolution MSC.391(95) International Code of Safety for Ships Using Gases or Other Low-Flashpoint Fuels (IGF Code), 2015
- [5] Zincir, B. and Dere, C. Adaptation of LNG Fuel System Workout to A Simulator for Training Purpose of Engine Officers. In: *Proceedings ICERS12, International Conference on Engine Room Simulators*. Turkey: Teknopark Istanbul, 2015, pp.115-122.
- [6] Veer Surendra Sai University of Technology, Burla, Odisha Lecture Notes on Internal Combustion Engine & Gas Turbines. India : VSSU, 2014. [viewed date 21 May 2018] Available from: <http://www.vssut.ac.in/lecture_notes/lecture1429900545.pdf>
- [7] The Hong Kong Polytechnic University, Course Plan. Hong Kong: HHPU, 2015. [viewed date 21 May 2018] Available from: <<https://www.polyu.edu.hk/me/files/List%20of%20subject%202017-18/ME44005%20Alternative%20Fuels.pdf>>
- [8] World Maritime University, Postgraduate Diploma in Executive Management. Malmö: WMU, 2017. [viewed date 21 May 2018] Available from: <https://www.wmu.se/sites/default/files/documents/files/Maritime%20Academy_WMU%20Brochure%202017_Web%20%281%29.pdf>
- [9] International Maritime Organization. The International Convention on Standards of Training, Certification and Watchkeeping for Seafarers, Amendments to the International Convention on Standards of Training, Certification, and Watchkeeping for Seafarers, Annex 6, 2015

ANALYZING STUDENT FEEDBACK FROM THE 2017 IAMU STUDENT FORUM: CHARTING PATHS TO THE FUTURE

Anan Yang[†], Matthew Rooks*

Kobe University Graduate School of Maritime Sciences (KUGSMS)

5-1-1 Fukaeminami-machi, Higashinada-ku,

Kobe 658-0022, Japan

[†] e-mail: 15104803512@163.com

*e-mail: rooks@maritime.kobe-u.ac.jp, web page: www.kobemaritime.com

Keywords: MET, student forum, feedback analysis

Abstract

The 2017 IAMU Student Forum, jointly organized by IAMU and IMO, was held at the IMO Headquarters in London, England from July 11-13. The student forum was a global event in every sense: 59 students from 52 IAMU member universities, hailing from 30 different countries participated in the event, making it a truly international and multicultural experience for everyone involved. During the student forum, participants had the opportunity to connect and collaborate with world-leading researchers, educators, and experts from the maritime industry while under the auspices of the IMO.

This paper summarizes the workshop outcomes of the 2017 IAMU Student Forum, and analyzes the post-workshop feedback that was collected from the student participants. While the student feedback was overwhelmingly positive for the event, indicating high levels of learning and knowledge gains, encouraging rates of participant satisfaction, and demonstrating signs of successful networking between the participants, there is still much to be learned from the general survey feedback and specific participant comments that will help guide future activities to be even more successful.

1 Introduction

The 2017 IAMU Student Forum, jointly organized by IAMU and IMO, was held at the IMO Headquarters in London, England from July 11-13. The student forum was a global event in every sense: 59 students from 52 IAMU member universities, hailing from 30 different countries participated in the event, making it a truly international and multicultural experience for everyone involved. During the student forum, participants had the opportunity to connect and collaborate with world-leading

researchers, educators, and experts from the maritime industry while under the auspices of the IMO.

The IAMU Student Forum was held in conjunction with IMO's World Maritime Day 2017, which theme was "Connecting ships, ports, and people." This theme was chosen to highlight the vast and diverse components of the maritime industry, and the forum workshops were designed to mirror this concept using a student-centered methodology. The workshop part of the forum consisted of 5 different groups, each assigned with the difficult task of addressing complex issues currently facing the maritime industry. The 5 workshop topics were the "Attraction, retention, and attrition of seafarers," "Global maritime professionals," "Ports and shore-based business," "Quality training on board for the first license," and "Gender in the maritime industry." Over the course of the forum, students worked under the supervision of facilitators and co-facilitators, who were assigned to each group, to identify the underlying issues at the heart of each topic while also coming up with unique suggestions and solutions for dealing with them. This paper will provide an overview of the forum, and also analyze participant feedback on the forum to help identify any weak points of the event with the hopes of improvement for future activities.

2 IAMU Student Forum Overview

One of the main goals of the 2017 IAMU Student Forum was to engage the student participants in a learner-centric approach that would encourage them to work interdependently on well-defined learning tasks. In order to facilitate cooperative learning, each participant was responsible for their own performance, verbalizing their ideas, and conducting their own work while the group facilitators guided the group-learning process, interacting with students in a personal, dialogic fashion rather than being overly directive or authoritative [1]. One of the main objectives for the group facilitators were not to focus on overt instruction, but rather on clarifying topic expectations, catalyzing dialogue, circulating actively among the group members, reinforcing positive instances of cooperative behavior, and issuing timely questions designed to promote elaboration and encourage higher-order thinking [2].

Another goal of the 2017 IAMU Student Forum was to overcome the serious disadvantages of traditional teacher-centric education by encouraging students to actively find links between theory and practice. Group work plays an important role in the development and maturity of personality while also playing an essential role in the process of socialization [3]. This student-centric learning approach was built into the workshop topics and discussion results as the students tried to understand not only the topics themselves, but also their underlying concepts, mechanisms, and tangential themes. Participants in the forum not only acquired the necessary understanding of the designated topics, but also developed generic competencies such as communication

skills, problem solving, and team work spirit, which are the hallmarks of task-based learning methodology [4].

In today's global economy, it is imperative to focus on international, multicultural and cross-cultural awareness. More and more students and lecturers are implementing new approaches to the concept of leadership in different cultural populations. However, many people lack the training to engage and fully comprehend the meaning of “multicultural coexistence” and “cross-cultural awareness” [5]. To compound matters, many gaps and problems exist within most of the educational systems throughout the world; outdated educational systems do not incorporate components pertaining to leadership training, international relations, and may have low levels of international cooperative research [5], let alone curricula objectives focusing on “multicultural coexistence” and “cross-cultural awareness.”

Due to the global nature of shipping and maritime business, cross-cultural awareness is a critical competence for maritime professionals. In order to address this need, the development and implementation of “a multicultural education movement” needs to be considered [6]. Recently, short-term programs like the Maritime International Exchange (MIX) have been created as a means for maritime education and training (MET) programs to integrate cross-cultural learning and other maritime competencies into a comprehensive learning module [7]. Other programs and events like the IAMU Student Forum have been created to address the growing need to train the international leaders of the future maritime industry. In July 2017, IAMU and IMO collaborated to host the second IAMU Student Forum, which was held at the IMO headquarters in London with the aim of providing students from various maritime universities around the globe with a chance to develop their cross-cultural awareness while focusing on a multitude of issues affecting the maritime industry today. While participating in the forum, the students were encouraged to openly express their own views and opinions, while also coming up with unique suggestions and solutions for dealing with each complex topic.

The theme of the Forum mirrored World Maritime Day 2017: Connecting ships, ports and people. The main objectives of the Forum were to broaden knowledge of the future maritime community by breaking down barriers and strengthening communications; to strengthen education in maritime fields with a particular focus on STCW-related degrees for Officers license, maritime business, logistics, and maritime engineering; to bring together the IAMU community with a focus on the future and tomorrow's leaders; to promote research in and for shipping by maritime personnel; and to promote the IMO and IAMU community to the world. The main event of the Forum was a workshop consisting of 5 different groups, each assigned with different tasks which were complex issues currently facing the maritime industry. The 5 workshop topics were the “Attraction, retention and attrition of seafarers,” “Global maritime professionals,” “Ports and shore-based business,” “Quality training on board for the first license,” and “Gender in the maritime industry.”

As part of their preparation for the Student Forum, there were sets of pre-workshop focus questions sent to the group members in advance which acted as a primer for the participants to get acquainted with the issues and topics. Team members spent time analyzing each element of these focus questions to come up with a better understanding of the inter-relationship of their topics and activate their pre-existing maritime knowledge. The participants were also reminded to keep open minds and think about issues from new perspectives. “This was a great chance to hear and understand ideas from other people who have totally different cultural backgrounds. No matter how different the idea points might be we can always learn something from others” Student F said. At the conclusion of the workshop, each group gave a presentation on their discussion contents and suggestions for dealing with the complex issues. After the Forum finished, the students were completed a feedback survey on the event. The anonymous survey asked the participants to remark on what they learned during the Forum, what benefits they believe they gained from the forum, what was the least interesting aspect about the forum, and what was most interesting aspect about the forum. The Forum, which was sponsored by The Nippon Foundation via IAMU, both NPOs, played an important and unique role in the maritime students’ leadership and cultural competence development [8] and serves as an interesting case model for potential future endeavors that can help young maritime students and cadets develop key skills and a knowledge base for tackling the complicated issues awaiting future generations.

3 Analysis of Student Feedback from the Forum

The questions in the survey summarized above yielded data from 42 student participants. The students rated various aspects of the Forum using a 5 point Likert Scale, and also provided further comments via open-ended responses. The first section of the survey asked participants to rate the amount and relevancy of information learned during the workshop. 68% of the respondents were very satisfied, and an additional 30% were satisfied, indicating that the participants were effectively meeting one of the main objectives for the Forum. One common reason students remarked on for this overwhelming satisfaction with the program could be attributed to the forum being a good opportunity for them to broaden knowledge of the community, break down barriers and strengthen global relations.

Survey results also indicated that another main objective of the forum, to bring together the IAMU community with a focus on the future and tomorrow’s leaders, was successfully fulfilled. According to collected results from the survey, 100% of respondents felt satisfied (82% of which were very satisfied) about the “Connections built with other participating students. Despite the various cultural and linguistic backgrounds, all of the survey respondents agreed that they had connected well together. "This is a great opportunity to meet students and professionals from all over the world and get the possibility to take part in very interesting discussions,” Student B wrote. Another common theme in student comments via the survey

indicated a heightened sense of, “multicultural coexistence” and “cross-cultural awareness,” competences that will help these future maritime professionals to solve conflicts and alleviate burdens that afflict the maritime industry [5]. “Even though the time was short, this was a very good opportunity to exchange knowledge and experiences. It is impressive to learn from others, especially because we realize we have the same challenges and that we should cooperate in the near future,” Student A wrote in their feedback. Student C had similar sentiments: “It is amazing that students from different countries and continents gather around to share their ideas and perceive other opinions. All together, we pushed for some results in the workshop.”

The survey also offered us a glimpse into some feedback about the facilitators and how they managed the groups. One survey question asked “Did the facilitator allow too much time for discussion, too little time, or about the right amount of time?” More than half of the participants (61%) indicated that the discussion time was the right amount, while 27% students think their facilitators allowed too much time. On the other hand, only 12% students felt the discussion time was too short. This data may be an indicator that perhaps that the topics assigned to each group had some inherent variance in complexity. i.e. some topics required less discussion time than others. One potential way to alleviate this problem would be to provide more time to students pre-Forum to read materials and have initial engagement with their topics to lay some of the groundwork for their later discussions. This would allow the participants to delve even deeper into their topics, and also open up more time during the actual event for other activities and inter-group interactions. The learned-centered instructional process may benefit from more pre-event scaffolding so that the groups of students can work interdependently on their learning tasks; and an online component could further ensure that each student is responsible for their own performance, verbalizing (or writing) their ideas, and actively participating in the group-learning process. [1]

The facilitators functioned partly as collegial coaches, interacting with students in a personal, dialogic fashion rather than being overly directive or authoritative. Furthermore, facilitators were instructed to clarify topic expectations, catalyze dialogue, circulate actively among the groups, reinforce positive instances of cooperative behavior, issue timely questions designed to promote elaboration and encourage higher-order thinking. Moreover, the opportunity to interact with participants in small groups may not only benefit the group members but may also enable the facilitators to know the students much better about their mode of thinking, communication and relating to others [1]. This particular learning style was chosen for the Forum so that facilitators could enrich their group work experience and become better-acquainted with the students in their groups [2].

Previous research shows that group-based projects and group discussions should be carefully structured; to maximize efficiency, students must be thoroughly prepared through social skill-building activities, assignments must be open-ended rather than

have preset answers, and the task must be such that a group, rather than only an individual, is truly required to accomplish it [9]. Though most students had either formal or informal experience with group work at the high school or university level in their respective countries, they may not treat these previous experiences as generally positive. “In my school, I have a leadership class once in a week but my teacher seems confused how to teach us about ‘leadership’ ……It was such a boring class before but the forum helped me to consider about what leadership means” Student I said.

This forum was of great significance and overcame some of the serious disadvantages of traditional education by encouraging links between theory and practice, and better use of learning. Group work plays an important role in the development and maturity of personality while also playing a momentous factor in the process of socialization [3]. The participants in this forum acquired not only the necessary understanding of their individual topics, but also received professional knowledge relating to the themes and generic competencies such as communication skills, problem solving and team building skills [4]. “The best part of the forum was the group work, as this was a very good opportunity to exchange knowledge and experiences. It is impressive to learn so much from others, especially because we realize we have same challenges so we can cooperate in the near future” Student J said.

When the students were asked “How well-structured was this event ?” 85% of them chose “very satisfied” and the remaining 15% of respondents chose satisfied, which is another indicator of the high level of success of the event. The Forum itself was relatively short, having only 3 days for all activities including the Welcome Reception, Opening Ceremony, Workshop, Presentations, Closing Ceremony, and Technical Tour. Due to the limited time, the facilitators had to keep a close eye on things, keeping the student discussions on task and moving things along as much as possible, while motivating the students, increasing their participation, and making sure that everyone was applying and enjoying themselves. “ I spent time witnessing how each group tackled the assigned topic and provided some input only when it was sought. One of the facilitators noted that “my co-facilitator was very supportive and provided his input whenever required.” Meanwhile, students were making new friends who had the same dreams and goals while enjoying the thrill of their visit to London (the first for many). “It was such a wonderful time and I was so impressed from everyone I met and everything I saw. The other students gave me a new motivation to study much harder and achieve my dreams ” student F wrote. By means of deep-seated discussions on the thorny problems faced by the maritime industry, students learned professional knowledge, gained valuable experience, and widened cultural awareness while improving their communication skills and effectively increasing their confidence with as English a second or foreign language.

4 Suggestions for improvement and development

Although the participant satisfaction with the Student Forum was overwhelmingly positive, the feedback did reveal some potential areas for improvement. Some students thought they didn't have enough time to prepare and present their discussion findings properly in a professional way. Moreover, there was not enough time for outcome discussions with other groups. Some students indicated that they would have benefitted from more preparation time before the actual Forum, as that would enable even deeper levels of discourse analysis. Many of the group members felt that the workshop only offered chances to communicate with their own group members, and desired more opportunities to connect with participants from other groups.

One potential solution to these problems would be to develop an online component where participants could gather together pre and post-Forum for some initial forays and further reflections on their topics. The benefits of an online component would be multi-faceted, and allow facilitators and students to introduce themselves, communicate ideas in advance, promote mutual understanding, increase the tacit comprehension of the issues, and lay the foundation for the future contact and communication among other groups. An online group could also be an excellent place for facilitators and co-facilitators to share their professional experiences in the maritime sector, offer potential directions for discussion, and more effectively manage the limited time of the actual Forum to maximize contact hours together. Moreover, due to the various ages, backgrounds, and levels of students, some participants initially felt shy or lacked some confidence to communicate clearly in English. Providing participants with an online outlet where they could take more time to write out and express their opinions could speed up the acclimatization process for these students.

Student feedback also indicated that 15 minutes for final presentations was not enough to cover all the content related to their topics. By increasing the final presentations and subsequent Q&A sessions to 30 minutes, each group would be able to summarize their findings, and individual group members would have more chances to showcase the abilities and knowledge they gained during the Forum. It would also be pertinent to dedicate some time for each group to send their members to other groups to share their viewpoints and ideas, listen to feedback and fresh perspectives from other groups, and then bring that information back to their own group to further broaden their discussions. In this way, groups could strengthen the communication between groups and diversify their viewpoints.

5 Conclusion

Overall, participant feedback from the 2017 IAMU Student Forum indicates that the event was a great success. Under the guidance of facilitators and co-facilitators, the students achieved the objectives set out by the organizers, and through an active discourse of their topics, arrived at a deep understanding of the World Maritime Day theme "Connecting ships, ports, and people." Through their participation in the Forum, these future leaders of the maritime industry were able to broaden knowledge

of the future maritime community by breaking down barriers and strengthening communications, strengthen their comprehension of maritime fields with a particular focus on STCW-related degrees for Officers license, maritime business, logistics, and maritime engineering, bring together the IAMU community with a focus on the future, and to promote the IMO and IAMU community to the world. The student participants also improved their communication skills, further developed their multicultural awareness and team building skills, and took part in practical problem-based learning with real life issues that will continue to affect the maritime industry in the future. Hopefully the further improvement and implementation of events like the 2017 IAMU Student Forum can continue to be a basis for the development of future global maritime professionals.

References

- [1] Cuseo, J. "Cooperative learning vs. small-group discussions and group projects: The critical differences." *Cooperative learning and college teaching* 2.3 (1992): 5-10.
- [2] Leki, I. "A narrow thinking system: Nonnative-English-speaking students in group projects across the curriculum." *TESOL quarterly* 35.1 (2001): 39-67.
- [3] Gatfield, T. "Examining student satisfaction with group projects and peer assessment." *Assessment & Evaluation in Higher Education* 24.4 (1999): 365-377.
- [4] Harden, R. M., et al. "Task-based learning: the answer to integration and problem-based learning in the clinical years." *Medical Education-Oxford* 34.5 (2000): 391-397.
- [5] Nukaga, M. "Japanese Education in an Era of Internationalization: A Case Study of an Emerging Multicultural Coexistence Model" *International Journal of Japanese Sociology*, 2003, Number 12.
- [6] John U. Ogbu, "Understanding Cultural Diversity and Learning" Alumni Distinguished Professor of Anthropology, *First Published November 1, 1922*.
- [7] Szwed, P. S. and M. J. Rooks., "Maritime International Exchange (MIX): Designing Blended, Application-Focused Exchange Programs to Increase Cross-Cultural Learning.", IAMU Proceedings, 2015.
- [8] Do Ba Khang and Tun Lin Moe, "Success Criteria and Factors for International Development Projects: A Life-Cycle-Based Framework", *Project Management Journal*, 2008.
- [9] Cohen, S. "What Makes Teams Work: Group Effectiveness Research from the Shop Floor to the Executive Suite.", *Journal of Management*, 23(3): 239 – 290, 1997.

THE CASE-STUDIES BASED APPROACH IN MARITIME ENGLISH TEACHING

ZURAB BEZHANOVI*, TAMILA MIKELADZE, KRISTINE ZARBAZOIA,
SVETLANA RODINADZE

* The Foreign Languages Department
LEPL – Teaching University – Batumi State Maritime Academy (BSMA)
53 Rustaveli St., 6010 Batumi, Georgia
e-mail: z.bezhanovi@bsma.edu.ge, web page: <http://www.bsma.edu.ge>

Keywords: case study, maritime English, competence, approach

Summary. *Challenges of constantly increasing role of the English language proficiency under the conventional requirements of the International Maritime Organization (IMO) require implementation of Maritime English teaching within the frames of a set of different modern approaches aimed at the development of the above mentioned skills. Accordingly, the aim of the paper is to offer the results of analysis of the case study-based approach of English competence development, providing nautical cadets with the IMO-required language competence.*

1 INTRODUCTION

The English language competence is progressively becoming a mandatory requirement for all ranks of seafarers. The conventions, developed by the International maritime Organization (the IMO), clearly require the application of English in different spheres of marine activities. The International Safety Management Code specifies the need for seafarers to communicate in a common language. [1] Under requirements of the convention, regulating Safety of Life at Sea, on all vessels, to provide operative crew members safety issues, a sole working language shall be used and fixed in the vessels' log-books. [2] Simultaneously, the same convention requires that on merchant vessels the English language shall be applied on the navigation bridge to provide safety communication in three major directions: on-board communication, communication between the ships and communication between the ship and shore based stations. [2] In its turn, the Convention on Standards of Training, Certification and Watchkeeping for Seafarers finally shows the whole range of the English language competency requiring the officers in charge of navigational watch (the OOWs) to use printed and electronic nautical charts as well as a wide range of necessary nautical publications, including meteorological data and the information related with vessels' safety, security and operation, including contact with other vessels, shore-based services and to implement other obligations of the OOW including application of the IMO Standard Marine Communication Phrases (the IMO SMCP). [3] Accordingly, the absolute majority of the shipping companies

determine English as obligatory working language on board the merchant ships. Hence, the range of competence to be provided to the students of Marine specialties needs different approaches caused by different fields of their competence. Therefore, the provision of effective, outcomes-aimed teaching of Maritime English needs application of a set of different approaches intended to develop above stated competence development. Accordingly, the aim of the paper is to propose the different ways to provide the cadets with appropriate language competence.

2 THE HYPERTEXT-BASED APPROACH IN MARITIME ENGLISH TEACHING

In our opinion (based on application of the below stated at approach at BSMA), one of the useful methods to satisfy the needs presented above and subsequently to reach the stated objectives is to involve the practice of a hypertext application into Maritime English teaching. Hypertext provides playback, self-control and self-assessment options presenting a dual constructive educational outcome – as the academic activity, as well as, the factor increasing individual responsibility of the student. At the same time, distinctly from the analogue text, elastic essence of the hypertext ensures constant altering and development of its components in reply to course of studies or student demands. Consequently, a hypertext empowers adaptable linking and sharing of the educational data over the entire scheduled teaching catalogue. Accordingly, a hypertext, as the educational instrument, is the outcome of clearly planned and highly arranged/frequently corrected teaching strategy with the above-noted evident benefits, giving the tutors possibility of continuous tuning and upgrading of the existed training resources.

As a sample of vital advantage of the hypertext benefits in use within Maritime English training, we'd like to offer a set of six interrelated screenshots (taken from our own electronic interactive course) of the hypertext “A Cargo Ship Construction”, which ensures the students of Batumi State Maritime Academy with a set of simultaneously available hypertext conveniences.

Understanding of the specific marine texts for non-native English students is associated with understandable complications because of hardly supposable explanations of a large number of marine terms. Simultaneously, the hypertext provides its users possibility of:

Figure 1: screenshot of the hypertext with the whole text listening:



Figure 2: screenshot of the same hypertext with listening and reading of Georgian translation of (preliminarily chosen) key words



Figure 3: screenshot of hypertext with pictorial illustration of marine terminology:

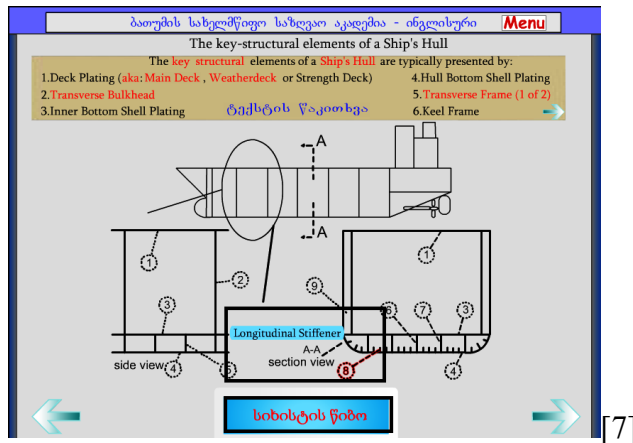

Figure 4: screenshot of usage of the picture as the knowledge development source – clicking the unknown part of a ship the student is immediately provided with the term’s pronunciation and translation (a picture in Maritime English is really worth a thousand words and explanations):

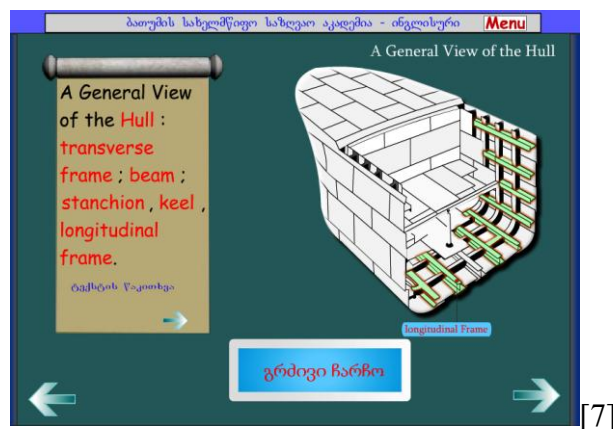

Figure 5: screenshot of the hypertext with related topics access:



Figure 6: screenshot of the hypertext with self-check, control and evaluation:



Thus, Maritime English training, following the general principle of CBT (computer based training) may benefit from development of HBT (hypertext based training), applying above mentioned advantages in provision both maritime teachers and students with opportunities of rapidly developing digital world.

3 THE CASE STUDY BASED APPROACH IN MARITIME ENGLISH TEACHING

Therefore, in case of development of students' competence related with acquisition of technical marine terminology, it is sufficiently enough to use Computer Based Training with application of hypertext advantages.

At the same time, it is also significant to consider the OOWs' obligations foreseen by the IMO model course "Leadership and Teamwork", implementation of which is directly interrelated with the increasing role of Maritime English. Thus, among other technical fields

of nautical proficiency, the officers' competence also includes implementation of operative safety management via on board and shore-based communication. [4]

Therefore, such wide range of the results to be achieved during the process of Maritime Education and Training implementation related to the language competence development, needs application of wide and elastic range of modern approaches actively used in different fields of skills - oriented education.

In our opinion, based on the gained experience, one of the most effective ways to ensure the students with appropriate knowledge and competence is to choose the suitable teaching data, causing the students' interest and accordingly making teaching useful and successful in results. Thus, one of the best ways to cause the future seafarers' interest is to provide them with the compilation of Presentation, Practice, Production (PPP) method involving real marine cases showing actual features of life and work aboard. Consequently, the paper offers a model of PPP lesson based on a real case study, aimed at provision of appropriate communication competence in case of such critically important issues, such as: contact, collision, capsizing, sinking, flooding and listing, fire, explosion and grounding (the frames of the paper do not give possibility to put the whole set of intended material, that is why we offer only one brief scheme of the intended proposal).

3.1 Presentation, Practice, Production (PPP)/Case Study Arranged Lesson Sample

Thus, if our aim is to build up the lesson using the real case study, all the components (Presentation, Practice, Production) of the lesson are presented with examples of the real accident which took place at sea on board the merchant fleet. So, we offer to start the PPP/case study-arranged lesson with the warmer, presented by the real pictures, involving the students into discussion predicting what happened with these two vessels:

Figure 7: warmer activity: look at the pictures and decide what happened with these two vessels?



[5]

Then, as the review tool, the students are asked to define (in the frames of preliminarily provided material) the role and importance of the message markers of the IMO Standard Marine Communication Phrases (the IMO SMCP) in provision of effective and safe maritime communication.

As the next step of the lesson implementation, the students are given the hand-outs containing the brief summary of the real accident, when “containership CARINA STAR was proceeding eastward toward Hanshin Port through the Kanmon Passage in Kanmon Port. Japanese destroyer was proceeding westward through Kanmon Passage toward Sasebo Port. At 1956.09-12 hrs, October 27, 2009, the ships collided with each other in the vicinity of Moji Saki, Kita-Kyusyu City. Finally, CARINA STAR sustained a fracture opening on the starboard bow outer-plate, and KURAMA sustained substantial damage on the bow, which

caused both ships to catch a fire at the damaged part. Six crew members of KURAMA suffered injuries during the fire-fighting operations, and, there were no injuries among the crew of CARINA STAR.” [5]

As the next stage of PPP implementation, the students are elicited to suggest the possible reasons of the accident - listening part of the lesson introduces the transcript of the noted collision, indicating time, party and communication:

“19:18:22-50 Ship B to Kanmon MARTIS (KM): “We’ll proceed westward through Kanmon Strait.” KM to Ship B: “About 2 miles ahead of you, KAISHO-MARU, a vessel navigating in the opposite direction. The current there is 3 kn westward, falling.” Ship B to KM: “OK, roger. We will proceed with full attention.”

19:52:18-26 KM to Ship C: “Vessel behind you is approaching you. Pay attention.”

19:52:32-38 Ship C to KM: “Ok. It’s surpassing. Overtake me on my port side.”

19:52:38-44 KM to Ship C: “Ok. Then you should keep starboard side. You are now middle of the fairway. Move to starboard side right now. Over.”

19:52:46-55 Ship C to KM: “Ok, Ok. I will be a little course to starboard side.”

19:53:08-20 KM to Ship A: “CARINA STAR, vessel ahead of you, QUEEN ORCHID is moving to starboard side, so please overtake on her port side. Over.”

19:53:26 Ship A to KM: “Ok, roger, I will overtake.”

19:53:31-43 KM to Ship A: “Overtake on her port side, QUEEN ORCHID is moving to starboard side, but one M ahead of you, Japanese navy ship is coming. Pay attention. Over.”

19:53:46-49 Ship A to KM: “Ok, thank you, I will overtake on my port side.”

19:55:55-56:04 KM to Ship A: “CARINA STAR, opposite course vessel, pay attention.”

19:56:32-35 Ship B to KM: “Kanmon MARTIS, this is JDS KURAMA, Ship No. 144. Over.”

19:56:38-41 KM to Ship B: “CARINA STAR is getting extremely close to you. Pay attention. Take evasive action.”

19:56:42-48 Ship B to KM: “We collided with a tanker, in Hayatomo Seto. The tanker is on fire. Over.”

19:56:52-57 KM to Ship B: “Roger. Fix your condition of ship. Open this CH 16.”

19:57:18-27 Kanmon MARTIS to every station: “All stations, All stations, this is Kanmon MARTIS. 5 cables east of Kanmon Bridge, a JDS and vessel CARINA STAR collided and are stuck together. Vessels around there pay attention. This is Kanmon MARTIS.”” [5]

Then the students are given the extract from case investigation report, according to which: “Kanmon MARTIS, at the time of the occurrence of the accident, did not use the message marker of the IMO Standard Marine Communication Phrases. At the same time, the messages were in the imperative form in English and Master A, took the messages from Kanmon MARTIS as an order instead of an advice. Thus, Master A did not understand properly the relationship between a VTS and a ship master and the meaning of the messages.” [5]

As the final production part of the lesson, the students are offered to make presentation under the following conclusive instructions:

Presentation/Role Play: Using the following components (a sample presented below), put necessary corrections into the above mentioned VTS-MV/MV-VTS communication and avoid collision: Do not forget to apply Standard Organizational Phrases (advise to remain (or change to) on a VHF Channel, use corrections and repetitions; do not forget about readiness and responses; take into account, that numbers are to be spoken in separate digits and a few digits and numbers have a modified pronunciation; note, that distances to be expressed in

nautical miles or cables; speed to be expressed in knots; times should be expressed in the 24 hour in UTC; do not forget to use the following message markers: Instruction, Advice, Warning, Information, Question, Answer, Request, Intention. [6]

Sample:

VTs: "Please use IMO Standard Marine Communication Phrases." Over

MV: "I will use IMO Standard Marine Communication Phrases." Over

VTs: "How do you read (me)?" Over

MV: "I read you fair. Over

VTs: "Advise (you) change to VHF Channel ... / frequency" Over

MV: "Changing to VHF Ch. .. / frequency ..." / "I'm ready to receive your message." Over

VTs: INSTRUCTION: Do not overtake. Repeat. Do not overtake. Over

MV: "Yes I will not overtake" Over/Out

Conclusion

Thus, modern maritime education and training is shifting from traditional model into a wide range one, in which the creative approach of combination of teaching methods and approaches is of principal importance. Accordingly, selection of both form (hypertext) and content (real accident cases) of teaching data provision should also follow the challenges of this process. Thus, hypertext and case study can play a significant role in reshaping the traditional English language resources to respond to modern maritime education needs, decreasing the gaps that exist between maritime needs and the outputs of education system. The application of the above mentioned approaches in Maritime English teaching can raise access to learning opportunities. It can help to improve the quality of education with advanced teaching methods, progress learning outcomes and enable better planning of unlimitedly flexible educational programs.

REFERENCES

- [1] ISM Code with Guidelines for its Implementation, London, IMO, 2014
- [2] The International Convention for the Safety of Life at Sea (SOLAS) Consolidated Edition, London, IMO, 2014
- [3] The International Convention on Standards of Training, Certification and Watchkeeping for Seafarers (STCW), London, IMO, 2011
- [4] Model Course 1.39 Leadership & Teamwork, London, IMO, 2014
- [5] MA2011-6, MARINE ACCIDENT INVESTIGATION REPORT, Japan Transport Safety Board, 2011 [online]. [viewed date 10 May 2018]. Available from: http://www.mlit.go.jp/jtsb/eng-mar_report/2011/2009tk0009e.pdf
- [6] SMCP with pronunciation guide, London, IMO, 2002
- [7] Z. Bezhanovi, An Interactive Course in Maritime English, Batumi, 2010

CHALLENGES IN THE FORMATION OF MARINE ENGINEERS. GOALS AND OPPORTUNITIES IN THE EDUCATION AND TRAINING OF MARINE TECHNOLOGY.

P. Casals-Torrens¹, R. Bosch¹, F. Diaz-Gonzalez¹, J. Nicolas-Apruzzese¹ and V. Fuses¹

¹Department of Electrical Engineering
Barcelona School of Nautical Studies (FNB)
Universitat Politècnica de Catalunya – BarcelonaTech
Pla de Plau, 18, 08003 Barcelona, Spain
e-mail: p.casals@upc.edu, Web page: <http://www.fnb.upc.edu>

Keywords: Training of marine electrical technology, electric ships, smart grids, big data, marine engineers, STCW.

Abstract. *The design of merchant ships and super-yachts every day is more complex, due to the continuous technological advances that they incorporate in their systems, either for their own operation and propulsion, as well as for comfort and safety. This evolution leads to an increase in energy demand, requires an increase in electrical services on board, forces these systems to also evolve with new concepts to improve the generation, distribution and demand of consumers. Supervision and regulation systems must optimise these operations, improve their performance and reduce emissions (greenhouse gases). An extensive network of sensors, their supervision, control and data acquisition (SCADA) is required. Overall, it represents a technical and qualification challenge for marine engineers who have to manage these systems. The paper presents how the current curriculums of Bachelor degrees and Master degrees of the Barcelona School of Nautical Studies (FNB), have incorporated the requirements for ship engineer officers and the new Electro-Technical Officer (ETO), in the area related to the function “Electrical, electronic and control engineering” included in STCW Code (2010 Manila Amendments). The new training challenges are also presented, which the current requirements of STCW Code and the IMO model course do not contemplate, and which should be taken into account in the study programs and their subjects in order to complement or expand them.*

1 INTRODUCTION

The strong knowledge, skills and abilities related to the annotated function “Electrical, electronic and control engineering” (STCW Code) [1], are indispensable for the marine engineer of today. The operation of the systems of a merchant ship and super-yachts, every day are technologically more specialised due to the continuous advances. The increase of the automatic systems of supervision, analysis and regulation of the different operations or services on board, is based on the use of computer applications. What it allows the centralised and optimise decision making, among which can be indicated, without being exhaustive: the ship positioning control (DP), energy management with the consequent improvement of

performance and emission reduction, safety, comfort on board, reduction of equipment maintenance costs, etc. All those have implied an important reduction or elimination of manual operations, traditional on engineering practice, and with the least possible number of crew members.

The changes that are taking place in the maritime industry also affect sub-sectors (clusters) or new business forms in the maritime world, where Europe has a dominant position. European yacht builders produce 60% of the mega yachts [2], Europeans dominate the emerging market for offshore renewable energy [2]. Catalonia, and especially Barcelona, can achieve a prominent position, providing qualified engineers and high added value maintenance and repair services to the superyacht subsector.

This requires, increasingly, to have specialists, on board and on land, who are able to operate, manage or inspect the vital services of a ship and the systems that compose them, such as:

- Electric Power Plant (including HV generation)
- Electric Propulsion (Azipods, including HV electric machines)
- Distribution network and protections (including HV grids)
- Supervision, control and data acquisition (SCADA) of sensors
- Programming of PLC's for data collection, control and command operations.
- Programming of converters and frequency inverters, for the operation of electric motors.
- Communication networks between computer equipment
- Radio / Radar Communication Engineering

All these services, managed as a set, under concepts such as Smart Grids [3,4,5], Big Data (Voyage data recorders VDR [6,7,8] and System for monitoring, reporting and verification of CO₂ emissions, MRV [9, 10]), should be integrated within the academic knowledge.

The paper presents how the current curriculums of Bachelor degrees and Master degrees of the Barcelona School of Nautical Studies (FNB - UPC), have incorporated the new requirements for the certification of watchkeeping engineers, chief engineer officers and second engineer officers. Focused in the area related to the function “Electrical, electronic and control engineering”, provided in the Manila amendments to the part A of the STCW Code [1] and the consequences for maritime education and training resulting from them. The syllabus established in the IMO model course for the ETO [11] will be a basic reference in the development of the contents of Undergraduate (Bachelor) studies.

2 ACADEMIC DEGREE REQUIREMENTS FOR ENGINEERING OFFICERS

In Spain, the academic requirements to access the professional qualifications of the Merchant Navy are established in Royal Decrees 938/2014 [12] and 973/2009 [13] (both currently under revision update). These requirements, corresponding to the engineer officers, are indicated in Table 1.

Table 1: Academic degree requirements for engineering officers *

| Second Engineer Officers | Electro-Technical Officers | First Engineer Officers | Chief Engineer Officer |
|----------------------------------------|-------------------------------------------------------------------------------------------------------|---------------------------------------------------------------------------------------------------------------------------|---------------------------------------------------------------------------------------------------------------------------|
| Bachelor degree in Marine Technologies | Bachelor degree in Marine Technologies + Knowledge required of Section A-III/6 of the STCW code | Bachelor degree in Marine Technologies + Master degree in Management and Operation of Installations Energy Maritime | Bachelor degree in Marine Technologies + Master degree in Management and Operation of Installations Energy Maritime |

* Note: For simplicity, only degrees of the current syllabus in FNB are indicated in the table.

3 SPECIFIC STCW ELECTRICAL, ELECTRONIC AND CONTROL REQUIREMENTS FOR ENGINEERING OFFICERS

The mandatory minimum requirements of competence, knowledge, understanding and proficiency, for certification of the officers in charge of an engineering guard or as service engineers (second officers), electro-technical officers, first engineer officers or as chief engineer officers. They are established in accordance with the chapters and sections of the STCW Code [1], indicated in the summary of table 2.

Table 2: Specific STCW electrical, electronic and control requirements for engineering officers

| Second Engineer Officers | Electro-Technical Officers | First Engineer Officers | Chief Engineer Officer |
|--------------------------------------------|-------------------------------------------------------------------|------------------------------------------------------------------|------------------------------------------------------------------|
| Minimum STCW code requirements in syllabus | Minimum STCW code requirements in syllabus | Minimum STCW code requirements in syllabus | Minimum STCW code requirements in syllabus |
| Section A-III/1 ⁽¹⁾ | Section A-III/1 ⁽¹⁾ and Section A-III/6 ⁽¹⁾ | Section A-III/1 ⁽¹⁾ Section A-III/2 ⁽²⁾ | Section A-III/1 ⁽¹⁾ Section A-III/2 ⁽²⁾ |

Note: ⁽¹⁾Operational and ⁽²⁾Management requirements [1].

4 GENERAL DESCRIPTION OF THE CURRICULUM DEGREE AND MASTER DEGREE OF THE TECHNICAL UNIVERSITY OF CATALONIA – FNB SCHOOL

This section describes how specifically the function “Electrical, electronic and control engineering”, provided in the STCW Code [1], mandatory minimum requirements for engineering officers, are incorporated into the academic studies.

The current curriculum of the Bachelor degree and Master degree structure the subjects to ensure a flexible organisation, being able to respond with efficiency objectives in training schedule and incorporate all the functions provided in the STCW Code [1].

4.1 Curriculum Structure of the Bachelor Degree in Marine Technologies (GTM)

The following table 3 shows the distribution of credits, depending on the types of subjects and assigned credits. Table 4 reflects the number of credits that incorporate training competencies for the function “Electrical, electronic and control engineering at the operational level” for Second Engineer officers and Electro-Technical officers (table 2).

Table 3: Distribution of subjects and credits (GTM)

| Types of subjects | Credits number (ECTS)** |
|-------------------|-------------------------|
| Basic training | 60 |
| Compulsory | 132 |
| Optional | 6 |
| Internship | 30 |
| Final Project | 12 |
| Total credits | 240 |

** Note: European Credit Transfer System

Table 4: Distribution of competences STCW

| Competences STCW Code | Credits number (ECTS)** |
|--------------------------------------------------------------------------------|-------------------------|
| Electrical, electronic and control engineering, for Second Engineer Officers | 34,5 (14,4%) |
| Electrical, electronic and control engineering, for Electro-Technical Officers | 30 (12,5%) |
| Total credits (GTM) | 64,5 (26,9%) |

The transposition of competences in subjects in the academic degree, are represented in summary form in the figures 1 for Second Engineer officers and the figures 2 for Electro-Technical officers, respectively.

4.2 Curriculum Structure of the Master Degree in Management and Operation of Installations Energy Maritime (MUGOIEM)

The following table 5 shows the distribution of credits, depending on the types of subjects and assigned credits. Table 6 reflects the number of credits that incorporate training competencies for the function “Electrical, electronic and control engineering at the management level” for First engineer officers and Chief Engineer officer (table 2).

Table 5: Distribution of subjects and credits (MUGOIEM)

| Types of subjects | Credits number (ECTS)** |
|-------------------|-------------------------|
| Compulsory | 75 |
| Master's Thesis | 15 |
| Total credits | 90 |

** Note: European Credit Transfer System

Table 6: Distribution of competences STCW

| Competences STCW Code | Credits number (ECTS)** |
|----------------------------------------------------|-------------------------|
| First engineer officers and Chief Engineer Officer | 20 (22,2 %) |
| Total credits (MUGOIEM) | 20 (22,2 %) |

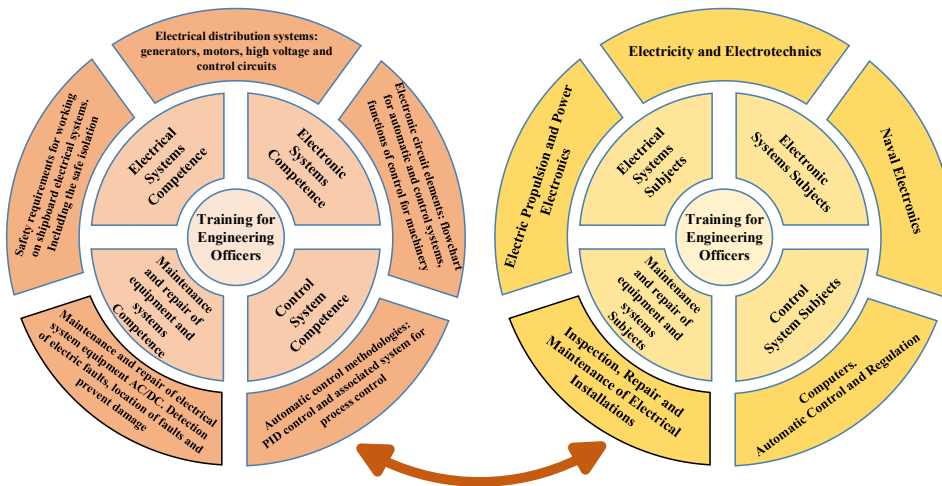

Figure 1: Transposition of competences in subjects of the Bachelor degree (GTM)

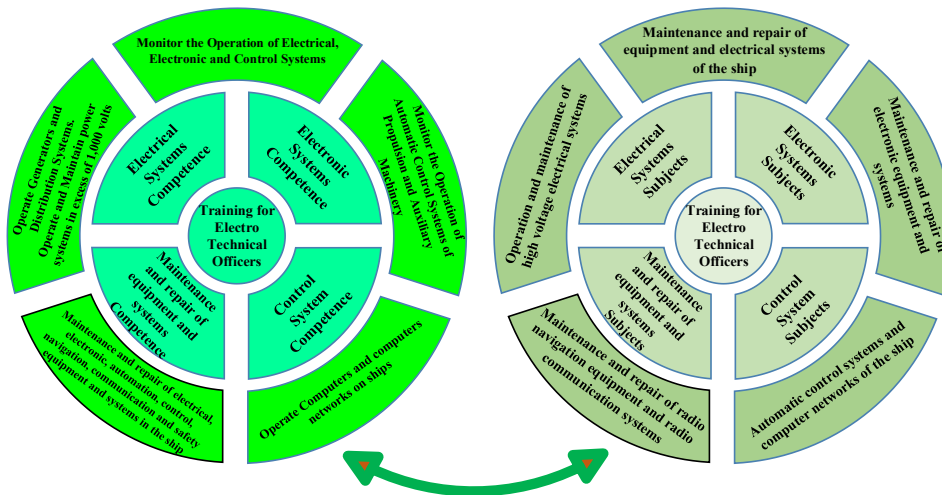

Figure 2: Transposition of competences in subjects for training ETO

5 TECHNOLOGICAL ADVANCES IN SHIPS, NEW TRAINING NEEDS AND CHALLENGES IN ACADEMIC TRAINING FOR FNB SCHOOL

In this section, we will describe briefly some of the changes that are taking place in the electrical systems of ships (power plant and propulsion), the control and automation systems and the necessary networks for the collection of information in the efficient management of energy and the control and reduction of emissions. These new advances and technological realities on board, cause a reduction of crew and necessarily forced to have highly specialised marine engineer's officers, capable of facing them.

5.1 Power plant, electric propulsion, distribution network and protections

The extensive electrification of the ship's systems, including its propulsion, known as "all electric ship" (aes). is a consequence of the need for more efficient ships and of proven

advantages, such as: superior dynamic control, improved maneuverability, greater flexibility of engine location, reduction of fuel consumption (thanks to the optimal adjustment of the number of thermal engines in service), reduction of vibration, high automation of the engine room. these events have caused significant changes in the entire design of the ship, so that, currently, 100% of the newly built cruisers are electrically propelled and a similar evolution occurs for other classes of offshore vessels such as supply ships, drillers, platforms, layers of pipes / cables, icebreakers, megayachts [14], evolution that can move towards direct current (dc) generation systems [3, 4, 14]. examples of new technological applications [3, 4, 14, 15, 16], that need focused training on:

- Great powers of generation and propulsion in high voltage
- Distribution in HV, facility security, monitoring of partial discharges (PD)
- Distributed generation (DG) and new criteria in the application of protections
- Generation in direct current (HVDC) and the large difficulty with DC circuit breakers
- Permanent magnet synchronous generator or motor (PMSG / PMSM)
- Management of the starting transients of the large electric motors
- Shore Connection or Cold Ironing On-board installation

5.2 Power electronic converters

The introduction in the ships of power electronic devices, such as power electronic converters (rectifiers, frequency inverters, phase controllers, variable speed drivers, starters, real-time machine control systems, etc.), has allowed us to redesign completely the structure of the systems of generation, distribution (Fig. 3a) and use of energy on board [3, 4, 14, 15]. The electric power feeds all the loads on board (propulsion, hotel and auxiliary), with electrical machines that can act as propulsion engine or help as generators at key moments (Fig. 3b). More than "present a classification of power electronics converters and areas of their application on ships", actually is necessary a deeper knowledge of its use. Need of specifically and focused training on:

- Configuration of parameters
- Selection of speed reference (local or remote)
- Frequency of output settings (upper limit and lower limit)
- Selection of direction of rotation (local or remote)
- Enabling ramps. Acceleration and deceleration ramp settings
- Connection of peripheral devices (contactors, relays, etc.)
- Custom U/f ratio settings
- Programmable protection functions settings (against blocking, internal fault, etc.)
- Pre-programmed faults settings (thermal, overcurrent, short circuit, overvoltage, etc.)
- Setting limits of operation (power, timed functions, load curves, energy optimisation)
- Control of the power flow and load sharing between the various power sources

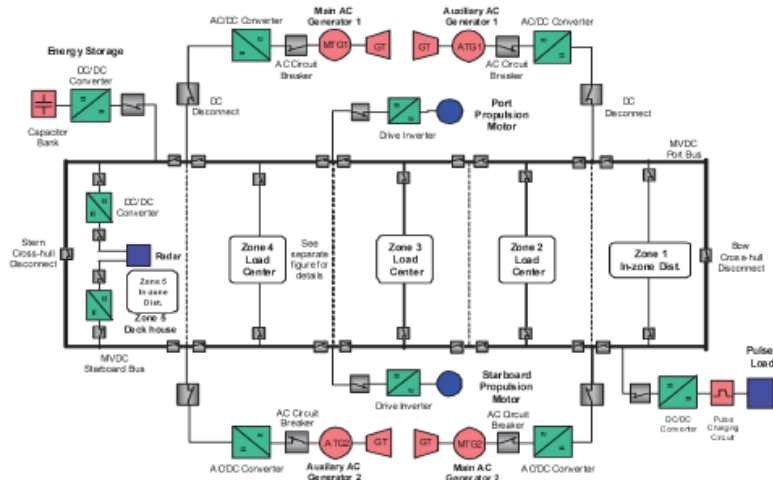

a) Zonal distribution. Source [14]

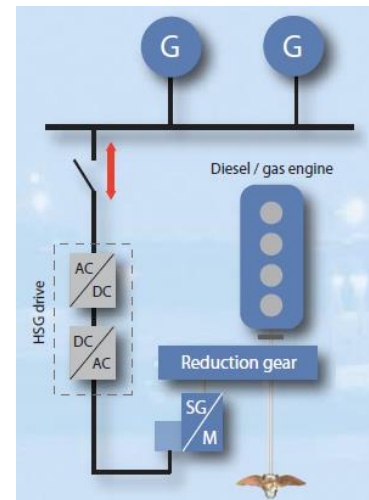

b) Grid with HSG drive.
Source: Rolls-Royce marine web

Figure 3: New configurations of grids in ships

5.3 Supervision and control of operations. Data acquisition (PLC's and SCADA)

Typical SCADA system consists of one more field data interface devices usually PLCs which interface to field sensing devices (level meters, water flow, valve position, temperature, pressure, power consumption, etc.), local control switch boxes and actuators device, all them provide information that can tell how well the systems performs. A communication system is used to transfer data among field data interface devices, control units and the computers to the SCADA central host which is a central computer server. The benefits of SCADA systems provide operational costs reduction, immediate knowledge of system performance, an improvement on system efficiency and performance, increasing equipment life, reducing the cost of repairs, frees up personnel for other task, facilitating compliance with regulatory agencies through automated report generating. Need for specific and focused training on:

- Know the communication protocols (Profibus, Modbus, industrial Ethernet network, Standard protocols of IEC)
- Communication between Client and Server. Modes SDO (Service Data Objects) and PDO (Process Data Objects)
- Programming and development of practical applications with PLCs
- Operations with an external control signal

5.4 Smart Grids and Big Data

The future of 'smart ships', requires having of smart grids for harnessing of the all the information and data that comes from of operational control, of voyage, the emission control and energy efficiency measures, during ship navigation, and focus this under Big Data applications. As the name implies, Big Data (data mining) gathers large volumes of information from a variety of sources and various statistical analysis and machine learning techniques are implemented under such data analytics, often at great speed, supported by database management [5, 6, 8]. This transformation has been possible thanks to the growing application and development of advanced sensor technology that allows generating and collecting large data volumes of fuel, traffic, cargo, weather and other data on board a ship [8, 17]. The analysing this information with effective systems still faces some challenges.

They also benefit from this technology, the management of the respective emission control regulations or efficiency index [6, 7, 8, 9, 10], such as:

- Regulations for the reduction of CO₂ emissions:
 - Energy Efficiency Design Index (EEDI)
 - Energy Efficiency Operational Indicator (EEOI),
 - Ship Energy Efficiency Management Plan (SEEMP)
 - The system for monitoring, reporting and verification (MRV), UE regulations
- Ozone Depleting Substances (ODS), Particulate Matter (PM), Volatile Organic Compounds (VOC's), Sulphur Oxides (SO_x) or Nitrogen Oxides (NO_x) limits
- Voyage data recorder (VDR)

This regulations and controls are forcing shipping operators to think more seriously the emissions performance from maritime transport fuel.

6 CONCLUSIONS

The current curriculums of FNB have to absorb not only the STCW requirements but also improve academic qualities and qualifications for marine engineers in order to provide flexibility in employment opportunities and give them the real competence to face the challenges of the future.

The marine engineer increasingly needs a very specialised electro-technical training, which should lead to establishing new levels of official training for them.

The contents pointed out in section 5 should be incorporated in the programs, to keep them updated concerning technological advances. Many of them have already been incorporated in the FNB, in particular, the contents indicated in sections 5.1, 5.2 and 5.3, have been incorporated into the subjects of ETO specialisation courses and the 20 credits provided for the function "Electrical, electronic and control engineering at the management level", in the master. However, besides all and these advances, we aren't lose sight of the convenience to improve and consolidate them.

The Smart Grids and Big Data, pointed out in section 5.4, it continues to be a pending challenge and to require the complicity of more areas involved, and of a multidisciplinary team of professors, for to face this new technological leap, already present in the sector.

REFERENCES

- [1] IMO. Adoption of the final act and any instruments, resolutions and recommendations. Resulting from the work of the conference. Attachment 2 to the Final Act of the Conference. *Resolution 2 The Manila Amendments to the Seafarers' Training, Certification and Watchkeeping (STCW – 78) Code*. Manila conference August 2010. [viewed date: 11 of June 2018]. Available from: www.imo.org/en/OurWork/HumanElement/TrainingCertification/Documents/34.pdf
- [2] European Commission. Directorate-General for Maritime Affairs and Fisheries. The role of Maritime Clusters to enhance the strength and development in European maritime sectors. *Executive Summary*. 2009. ISBN 978-92-79-11559-2. [viewed date: 11 of June 2018]. Available from: https://ec.europa.eu/maritimeaffairs/sites/maritimeaffairs/files/docs/body/executive_summary_clusters_en.pdf
- [3] Fotis D. Kanellos; George J. Tsekouras; John Prousalidis. Onboard DC grid employing smart grid technology: challenges, state of the art and future prospects. *IET Electrical Systems in Transportation*. Year: 2015, Volume: 5, Issue: 1, Pages: 1 – 11. [viewed date: 11 of June 2018]. Available from: DOI: 10.1049/iet-est.2013.0056
- [4] Shantha Gamini Jayasinghe, Lasantha Meegahapola, Nuwantha Fernando, Zheming Jin and Josep M. Guerrero. Review of Ship Microgrids: System Architectures, Storage Technologies and Power Quality Aspects. *Inventions 2017*, 2, 4; pages: 3-19. [viewed date: 11 of June 2018]. Available from: DOI:10.3390/inventions2010004, www.mdpi.com/journal/inventions
- [5] Rolls-Royce Marine, Mikael Mäkinen, President. Autonomous ships. The next step. [on line]. 2016. [viewed date: 11 of June 2018]. Available from: <http://www.rolls-royce.com/~media/Files/R/Rolls-Royce/documents/customers/marine/ship-intel/rr-ship-intel-aawa-8pg.pdf>
- [6] Lokukaluge Prasad Perera. Maritime Big Data. *MARINTEK – Norwegian Marine Technology Research Institute*. 2016. [viewed date: 11 of June 2018]. Available from: DOI: 10.13140/RG.2.1.4839.9761
- [7] IMO. Guidelines on Voyage Data Recorder (VDR). Ownership and recovery. [on line]. May 2002. [viewed date: 11 of June 2018]. Available from: <http://www.imo.org/en/OurWork/Safety/Navigation/Documents/1024.pdf>
- [8] Big Data in the marine sector. *Maritime Journal* [on line]. April 2017. [viewed date: 11 of June 2018]. Available from: <http://www.maritimejournal.com/news101/onboard-systems/monitoring-and-control/big-data-in-the-marine-sector>

- [9] Regulation (EU) 2015/757 of the European Parliament and of the Council of 29 April 2015 on The monitoring, reporting and verification of carbon dioxide emissions from maritime transport, and amending Directive 2009/16/EC. [viewed date: 11 of June 2018]. Available from: <https://eur-lex.europa.eu/legal-content/EN/TXT/PDF/?uri=CELEX:32015R0757&from=EN>
- [10] DNV-GL. EU MRV Regulation Maritime Safer, Smarter, Greener. Get the details on Monitoring, Reporting and Verifying in line with the new EU MRV regulation – the smart way to comply. April 2017. [viewed date: 11 of June 2018]. Available from: <https://www.dnvgl.com/maritime/eu-mrv-regulation/how-to-prepare.html>
- [11] IMO. Model course 7.08. Electro-Technical Officer, 2014 Edition
- [12] España. Real Decreto 938/2014, de 7 de noviembre, por el que se modifica el Real Decreto 973/2009, de 12 de junio, por el que se regulan las titulaciones profesionales de la marina mercante. In: *Boletín oficial del Estado* [online]. Madrid: BOE, 8 November 2014, n. 271. BOE-A-2014-11560. [viewed date: 11 June 2018]. Available from: <https://www.boe.es/buscar/doc.php?id=BOE-A-2014-11560>
- [13] España. Real Decreto 973/2009, de 12 de junio, por el que se regulan las titulaciones profesionales de la marina mercante. In: *Boletín oficial del Estado* [online]. Madrid: BOE, 2 July 2009. n. 159. BOE-A-2009 10900. [viewed date: 11 June 2018]. Available from: <https://www.boe.es/buscar/act.php?id=BOE-A-2009-10900>
- [14] Giorgio Sulligoi, Andrea Vicenzutti and Roberto Menis, All-Electric Ship Design: From Electrical Propulsion to Integrated Electrical and Electronic Power Systems *IEEE Transactions on Transportation Electrification*, vol. 2, n° 4, pp 507 – 521, December 2016. [viewed date: 11 June 2018]. Available from: DOI: 10.1109/TTE.2016.2598078
- [15] James L. Kirtley, Jr., Arijit Banerjee and Steven Englebretson. Motors for Ship Propulsion. *Proceedings of the IEEE*, vol. 103, n° 12, pp 2320 – 2332. December 2015. [viewed date: 11 June 2018]. Available from: DOI: 10.1109/JPROC.2015.2487044
- [16] Espinosa, S.; Casals-Torrens, P.; Castells, M. Hoteling cruise ship's power requirements for high voltage shore connection installations. *Journal of Maritime Research*, vol. XIII, n° II, pp. 19-28. July 2016. [viewed date: 11 of June 2018]. Available from: URL: <https://www.jmr.unican.es/index.php/jmr/article/view/447/490>
- [17] Lokukaluge Prasad Perera. Handling Big Data in Ship Performance & Navigation Monitoring. Smart Ship Technology, 24-25 January 2017, London, UK, pp. 89-97. 2016. The Royal Institution of Naval Architects. [viewed date: 11 of June 2018]. Available from: URL: <https://www.researchgate.net/publication/312553263>

COMPARING NAUTICAL BSc PROGRAMS BY QUALITY INDICATORS

Tor Erik Jensen* and Tron Resnes†

*University College of Southeast Norway (USN) Department of Maritime Operations.
University College of Southeast Norway P.O.Box 235 3603 Kongsberg, Norway
e-mail: tej@usn.no, web page: <http://www.usn.no>

† Norwegian University of Science and Technology (NTNU)
Department of Ocean Operations and Civil Engineering
Larsgårdsveien 2 6002 Ålesund, Norway
e-mail: tre@ntnu.no, web page: <http://www.ntnu.no>

Keywords: Nautical, BSc programs, quality indicators, comparison, program measurement

1. PROBLEM AND METHOD

Merchant marine officers compete internationally for their positions and the maritime universities shall provide them with an education appropriate for working in an international industry requiring personnel with relevant qualifications, competencies and skills. Consequently, there is a need to measure institutional performance and it may be inspiring for those measured if it gives information and trust. Firstly, applicants and future candidates would know where to apply and their employers would know which candidates to employ. Secondly, funding governments, donors and staff, are informed of areas needed to improve.

1.1. Problem

The general problem when evaluating universities is to define and identify the institutional contribution to each candidate's competencies, skills and knowledge [2], or citing the STCW-code: Knowledge, understanding and proficiency (KUPs) as identified. Thus, top-grade students, including candidates intellectually above average, may learn whether or not enrolled in an institution providing an optimal learning environment, state-of-the-art facilities and excellent academic staff. Vice versa, the top institutions may lift below-average students to a level where they achieve the required competencies etc. and perform well within a profession.

Quality indicators suitable for measurement should give precise and easily understandable information with respect to which degree goals are met [3]. In addition, define and identify the institutional contribution with regard to achieving the goals and finally restrict the various stakeholders, like students and teaching staff, from manipulating the information given.

A particular problem when evaluating nautical BSc programs is that, despite the STCW-code, there is no international standard of measurement. Thus an exploratory method for comparison was made.

1.2. Method

The study developed a set of quality indicators in order to compare the institutions chosen, of which eleven of the twelve offered BSc degrees in nautical sciences.

The European Credit Transfer and Accumulation System (ECTS) and its equivalent for non-European universities were chosen as an instrument for comparison. Because of differences in credits in Asia, Europe and Americas, the equivalents to ECTS have been manually transformed by counting each subject and each number of hours taught or lectured. These systems of credits are standards with two aspects. One is to award students credits for workload per subject and exams, consequently to make transfers between universities more efficient. The other is to have transparency and standards for planning, delivery and evaluation. [4]. In addition, various data were compared: Entry criteria, retention- and failure rate. Also, the structure and content of the study program in relation to STCW, like nautical/maritime subjects beyond the STCW requirements and complementary subjects, i.e. the universities have a variety of subjects they include. Thereafter, a comparison of simulators and laboratories, the academic staff, and whether the program include a final thesis or project.

1.3. Interview guide

An interview guide was compiled in order to ensure a homogeneous data collection. The interview guide was based on the foregoing quality indicators [5].

1.4. Limitations

A total of twelve institutions took part in the mapping: Four in Europe, two in Asia and two in the Americas, comparing the four Norwegian BSc-programs in nautical science at UiT, NTNU, WNU and USN. All represent maritime nations with their academic tradition and views regarding education and learning, combined with what they themselves state as modern ways of training and educating merchant officers at sea.

Our criteria for selection: A world-wide perspective and maritime industrialized nations. Four institutions were visited; two in Europe, one in Asia and one in North America. For these interviews were made based on the interview guide. The remaining institutions reported their data in writing, based on the same guide. Before finalizing the study it was distributed to those participating for validation. Some of the data reported in writing were insufficient for comparison, resulting in challenges during the data analyses. One method of measurement which was not included is candidates' performance after graduation i.e. career goals, earnings.

2. DATA AND SAMPLE

There are two main models for structuring the curriculum of nautical BSc-programs containing the competencies in the STCW Code, or a combination of the two: 1) The "*sandwich model*" covers the competencies at the operational level, STCW A-II/1, subsequently the competencies at the management level, STCW A-II/2. 2) The "*integrated model*" covers both the operational and management level within the same subjects. 3) A combination of items 1 and 2 above. 4) Approved seagoing service in addition to the above.

2.1. Curriculum Structure

Table 1: Curriculum structure Overview institutions A- Nor4

| Institution | Model (see above) | Compulsory STCW subjects (ECTS or Equivalent) | Complementary subjects (ECTS or equivalent) | Nautical / beyond STCW requirements (ECTS or equivalent) | Thesis (ECTS or equivalent) | Sum ECTS or equivalent |
|---------------|-------------------------|-----------------------------------------------------------|------------------------------------------------------|----------------------------------------------------------------------|-----------------------------------|---------------------------|
| A | 2+4 (60ECTS) | 101 | 49 | 15 | 15 | 240 |
| B 1* | 2+4 (60 ECTS) | 97 | 33 | 50 | | 240 |
| B2 * | 2 | 97 | 33 | 115 | | 245 |
| C | 1+4 (60 ECTS) | 105 | 20 | 35 | 20 | 240 |
| D | 2+4 (60 ECTS) | 120 | 48 | 12 | n/a | 240 |
| E | 2 | 81 | 95*** | 0 | N/A | 176 |
| F **** | 2+4 (60 ECTS) | 127,5 | 22,5 | 15 | 15 | 240 |
| G ** | 1 + 4 (60 ECTS) | 133 | 47 | 0 | None | 240 |
| H | 2+4 (60 ECTS) | 103 | 30 | 35 | 12 | 240 |
| Nor1 | 2 | 100 | 50 | | 20 | 180 |
| Nor2 | 2 | 112,5 | 35 | 17,5 | 15 | 180 |
| Nor3 | 2 | 105 | 30 | 30 | 15 | 180 |
| Nor4 | 2 | 127,5 | 15 | 22,5 | 15 | 180 |

All eight institutions (A-H) include sea practice in their 4 year study programs, and institution B also has an alternative replacing sea practice with theoretical studies in fourth year. Institution G's program only cover operational level, and E including 90 ECTS non-nautical elective subjects. F's compulsory STCW subjects (127,5) include complementary work.

Six out of eight non-Norwegian institutions prefer an integrated model teaching the students operational and management competence included within the various subjects, i.e. no distinction between subject levels stating X is operational and Y is management level.

Regarding the integration between operational and management level, University C says that: *"we used to be more integrated in the past and now concentrate on a sandwich structure of the program"*. This is interesting because this strong emphasis on step-by-step learning comes from an institution with a long academic tradition. This merely indicates that more than one model may achieve the same goals, and eventually it is up to the teaching staff and their personal preferences.

In addition to this choice of model, five of these eight institutions have integrated seagoing practice, leading to a Certificate of Competence (CoC). Surely, the first year starts with basics, but as institution F says in our interview: *"First period at sea is at the start of the second semester. When the students return, working with complex tasks on the simulator makes so much more sense, and their ability to reflect upon situations and their acknowledgement of the navigational skills required have increased"*. Thus, integration of practice is regarded to stimulate a high level of understanding and if combined with written and verbal analysis, the students may achieve the required academic standards and practical

skills. The combination of practice and simulation is a form of problem-based learning (PBL) and a well proven structure for professional educations [6]. The Norwegian institutions do not include approved seagoing service in their curriculum, thus they have no responsibility or formal exams related to the cadet period. The certification is purely a matter for the Norwegian Maritime Authority (NMA).

2.2. Volume of simulator training

Table 2: Volume of simulator training institutions A- Nor4

| Institution | Number of semesters with STCW required simulator training | Simulator training beyond STCW requirements Type & Semesters | No. of students per full mission simulator | Total hrs. on navigational simulators | Total hrs. on other types of simulators or lab |
|-------------|------------------------------------------------------------------------------------------------------------------------------------------------------------------------------------------------------------------------------------|-----------------------------------------------------------------------------------------|--------------------------------------------|---------------------------------------|------------------------------------------------|
| A | <u>2 semesters:</u> 5 th semester ARPA and GMDSS simulator. 8 th semester ECDIS | Ship survey, Manoeuvring, Liquid Cargo handling i.e. Oil Tankers and Gas Carriers. | 3 | 63 | 354, including laboratory training |
| B | <u>2 semesters:</u> 5 th sem. Navigational simulator 6 th semester, ECDIS, ARPA and GMDSS | Ship handling, Liquid Cargo handling in elective subjects | 4, only used in elective subjects | 142 | Depends on subjects elected |
| C | <u>6 semesters</u> | Yes | 1-2 | 204 | 80 |
| D | <u>5 semesters</u> | Yes | 2-3 | 224 | 84 |
| E | <u>4 semesters</u> 4 th sem. Radar/ARPA 5 th sem. GMDSS 5 th & 6 th sem. ECDIS | Ship handling, Liquid Cargo handling | 5 | 189 | 198 |
| F | <u>8 semesters</u> | Yes | 2-3 | 216 | 92 |
| G | 2 plus 1 3 rd & 4 th sem. and between semesters the 2 nd and 4 th year | | 4 | 157 | |
| H | <u>4 semesters</u> 4 th sem. Radar/ARPA 5 th sem. ECDIS 5 th sem. GMDSS 7 th sem. LCHS and ERS (voluntary) 8 th sem. Ship handling / BTM. Offshore Navig. | Not identified in interview. Labs; radio (GMDSS), Navigational instruments, DP, etc. | 3 | 200 | 120 |

| | | | | | |
|--------------|-------------------------------------------------|------------------------------------------------------------------------------------------------------------------|----------------------------------------------------------|-----|--------------------------------------------------------|
| Nor 1 | 6 semesters | Not identified in interview. Labs; radio (GMDSS), Navigational instruments, Ship-hydrostatic lab, | 2 -3 | 216 | 100 Have available research vessel 2- 3 days. |
| Nor 2 | All six semesters have simulator training | Not identified in interview. Labs; radio (GMDSS), Navigational instruments, DP, Offshore ship handling | 2 | 336 | 104 |
| Nor 3 | 4 semesters | Not identified in interview. Labs; radio (GMDSS), Navigational instruments, DP, etc. | 2 (1 in some) BRM: 3 per bridge + 2-3 observing | 222 | 112 |
| Nor 4 | 4 semesters | Not identified in interview. Use of simulators and labs such as radio (GMDSS), Navigational instrum. DP | 2-4 | 226 | 124 |

Up-to-date equipment seems to be the standard for all 12 institutions with some variations. This gives them a platform for offering and developing modern adequate education. Also, most institutions have other simulators providing education and training within other areas than pure navigation and communications. The major difference is not in the variety of equipment, but how it is used. Some institutions introduce simulator training early in their programs, others later. Norwegian programs start early and the use of simulators seems to be well integrated throughout the three-year programs. This should be linked to the Norwegian role of developing the simulation of BRM, anchor handling and advanced offshore operations in close co-operation with the maritime industry. Here, problem based learning (PBL) shows its importance for nautical professional education, cfr. comments above.

There is a wide variation between chosen semesters and total hours in all; from 63 hours (institution A) to 334 hours (Nor 2). Institutions C, D, F, H and Nor 1, 3 and 4 have 200 hours or more. This must be seen together with other simulator and laboratory training as mentioned below, in order to get a holistic understanding of the learning outcome. Here we found again a huge variety ranging from 354 hours (institution A) to 80 hours (institution C). C, D, F, H and Nor 1-4 with more than 200 hours on navigational simulators have 80 to 124 hours on other types of simulators and laboratories. Institution E has an interesting model with a balance of 189 and 198 hours on navigational and other types of simulators respectively. Only institution F uses all eight semesters to teach compulsory STCW requirements; an observation here is that their integrated model seems to be stretched to its limits by maturing their students within the core element of the navigational skill and knowledge all through the program. However, the difference with institution C using six semesters and only 1-2 students or D and Nor 1-2 with five and six semesters respectively but in total more hours, may not be noticeable or viewed as significant. Nor 2 seems to emphasize simulator training giving their students 103 hours more than the average of compulsory simulator training.

3. DISCUSSION AND CONCLUSION

3.1. Curriculum structure and content

We divide the main purposes of a BSc in Nautical Science in two. Firstly, to fulfil the requirements of STCW Reg-II/1 and Reg-II/2, as well as the requirements of STCW Code A-II/1 and II/2. Secondly to give relevant competencies beyond this and achieve an academic standard at BSc-level. The competencies in the STCW Code are typically structured in four ways: 1) Cover the competencies at the operational level, A-II/1, subsequently the competencies at the management level, A-II/2. The so-called “sandwich model”. 2) Cover both the operational and management lever within the same subjects e.g. Meteorology. The so-called “integrated model”. 3) A combination of items 1 and 2 above. 4) Approved seagoing service in addition to one of the above.

Only institution G in the survey covers education limited to operational level, and only C and G have a sandwich model, teaching competencies at the operational level (STCW A-II/1) separated from competencies at the management level (STCW A-II/2). The others adopt an integrated model teaching operational and management competencies within same subject.

Five institutions have a 4-year BSc program including cadet training at operational level up to Certificate of Competence (CoC). Institution B has a particular variant in addition to the model with integrated training, where the sailing/cadet period is split between the first and second years of study and between the second and third years. The fourth year is purely theoretical with specialisation in seven different nautical / maritime subjects.

This integrated on board training is clearly different from the Norwegian model with its 3-year BSc program without any practical on board training up to CoC-level. Norway has chosen to assign responsibility for cadet training to private shipping companies after completion of a BSc program, without any form of final examination after the cadet period. However, there is documentation of on board training signed by an assessor with a particular training program as such and final approval from the NMA, and NMA has per date (2018) no objections to the system. However, reflecting upon the differences, we find solid arguments in favour of the integrated on board training during all four years of the BSc program:

When students return to the university after their seagoing practice, this training allows them to reflect on their experience together with their tutors and staff, thus the students have a systematic evaluation of skills and knowledge verifying that the average candidate acquires a thorough level of understanding and knowledge. This seems to be confirmed by our interviews and when asked about the effect of simulator training after a period on board, the tutors emphasised that students became more mature and understanding of training increased.

In comparison, the Norwegian model has a disadvantage from not integrating theory and practice, both with regard to the practical skills learned at sea and the academic level. This could possibly be modified by increasing the level of simulator training as discussed below, cfr. 3.2. On the other hand, the BSc curriculum including seagoing practice and cadet training leading to CoC, requires either available training ships or a formalized and predictable

cooperation with ship operators: Professional education within nautical science requires huge investments and a long-term perspective. Thus, for Norwegian institutions to co-operate with the maritime industry and ship managers requires both an intake level in line with offered ship capacities and managers that commit to accepting a certain number of cadets on board. This is really a discussion on quality vs. cost effectiveness.

Another aspect regarding curriculum structure is the academic profile. How far beyond compulsory and complementary STCW subjects do the institutions take their candidates?

Eight of the institutions have a concentration of ECTS points around 100 dedicated to compulsory STCW subjects. Four institutions differ, E with 81, F and NOR 4 with 127.5, while G seems special with 133 ECTS equivalents covering only operational level. In other words, the majority seem in line. These subjects typically cover mathematics, physics, language, history, etc. There is a great variety among the institutions, from Nor 4 with 15 ECTS to E with 95 ECTS equivalents.

International trends of development are of importance for leading institutions, because they set the standards and interact with the maritime industry's global and national authorities' demands. The basis for nautical programs is stipulated by STCW, however, even though this standard has been developed over the years, it is an IMO convention based system legally setting minimum requirements, while particular industrial segments and/or national maritime authorities may demand even higher standards [7]. Within STCW a good example is Bridge Resource Management (BRM) training, developed by maritime universities for maritime purposes over the last three to four decades [8]. Today it is part of STCW's requirements [9]. In other words, we advocate that in order to develop new concepts and innovative solutions efficiently one cannot await new formal and legally binding regulations, but must actively seek a dynamic collaboration between maritime universities and the maritime industry.

A new challenge is the development of autonomous ships. Technical, operational and nautical management are core issues, together with legal and commercial challenges. How can universities offer their students both theoretical understanding and achieve the skills needed in future autonomous ship operations?

One practical challenge of including new learning into existing programs is that over the years the STCW minimum standard has increased by including new concepts, but old ones not necessarily discarded. Thus, leaving few hours available for new innovations and program profiling. Nevertheless, we do find good examples of profiling programs with in-depth specialisations; Institutions B, C and D all have clear profiling. The latter has marine transportation and marine operations giving in depth specialization within transport/ logistics/ commerce and technical operational subjects accordingly. This specialisation could be seen together with the final project or thesis and be a part of the program profile. NOR 1-4 may improve their profiles and to a greater degree give in depth knowledge of the latest trends of technical, commercial and legal demands for navigation and ship operation. One solution is to increase the collaboration among the institutions, nationally and internationally. Nationally, we see Centres of Excellence (CoE) in higher education. Norway has eight centres [10] and a new proposal is under way, one could argue that the NOR 1-4 should develop a nautical CoE.

3.2. Volume of simulator training

The principal question from a Norwegian perspective is whether the disadvantage of non-integrated cadet practice is compensated for by increasing the level of simulator training. The Norwegian universities do have a higher number of training hours, but is the difference significant, and does the quality and type of training address the disadvantage in particular? The short answer is that as yet we do not know, and further studies are needed.

However, institution C, D, F have 204, 224 and 216 hours on navigational simulator respectively, and nor 1-4 with 216, 336, 222 and 226 hours, but only NOR 2 seems to have sufficient extra hours of training that may compensate to some degree. Combining the number of other simulators does not seem to change this overall picture. C, D, F have 284, 308 and 308 respectively, while NOR 1-4 have 316, 440, 334 and 350. Again, further studies are needed to know how to compensate for the disadvantage, or how to develop a Norwegian study model. A CoE in nautical studies is one way forward. Depending on capability of collaboration this can be developed combined for NOR 1-4 or by either one.

3.3. Conclusion

Integrated on board training / cadet period through 4- year BSc programs is preferred by institutions with both a general high academic standard and long maritime tradition, including nautical BSc programs. This stands in contrast to the Norwegian BSc model with no integrated cadet period. Compared with their foreign counterparts, Norwegian institutions do have a high volume of simulator training. This gives a solid platform for further development. Further research may develop new concepts for navigators and more efficient use of simulators may shorten practice at sea, and we advocate integrating on board practices and PBL concepts through the study program. This to be seen in context with the development of autonomous technology and its consequences for shipping and nautical education.

References

- [1] Markom2020 is a government-funded project comprising four Universities in Norway with BSc. in Nautical Sciences. The objective is to raise the overall quality of Norwegian Nautical BSc studies. The Markom-project T-79 from November 2016 maps the variety of structuring and modelling nautical science programs by means of indicators identifying the quality of selected Nautical Science programs Authors: Resnes, T. (NTNU) Eide, H. (NTNU) Trovåg, J.M. (HVL) Jensen, T.E. (USN).
- [2] Centre for Economic Research at NTNU; SØF-rapport 01/16, & Cunha, J.M.,T. Miller (2014): Measuring Value Added in Higher Education. Economics of Education Review 42, 64-77.
- [3] Centre for Economic Research at NTNU; SØF-rapport 05/16 (p.1) with further references
- [4] Cfr.Op.Cit. SØF-rapport 05/16 (p.1) with further references
- [5] Cfr. Markom-Project T-79 Report Appendix 2.
- [6] Strømsø, H.I., Lycke, K.H., Lauvås, P.(2016). *Når Læring er det Viktigste*. Cappelen Damm AS
- [7] Maritime safety and security; EU “Erika Package I, II and III”, cfr. EUR-Lex Erika Package.
- [8] Cfr. development of the ISM Code. Anderson, Phil ISM Code. LLP 2005
- [9] STCW Code A-II/1, A-II/2, A-III/1, A-III/2, A-III/6, A-VIII/1, and A-VIII/2
- [10] Cfr. Norwegian Centre for International Cooperation in education who release the calls.

DEVELOPMENT OF MARITIME EDUCATION AND TRAINING THROUGH HUMAN-WARE UPGRADING

Ahmed Kassar *, Abdalla Elmalt †

*Maritime Postgraduate Studies Institute
Arab Academy for Science, Technology and Maritime Transport (AASTMT)
Abukir, Alexandria – Egypt
e-mail: kassar@aast.edu. <http://www.aast.edu/en/index.php>

†Maritime Upgrading Studies Institute
Arab Academy for Science, Technology and Maritime Transport (AASTMT)
Abukir, Alexandria – Egypt
e-mail: abzi@hotmail.com. <http://www.aast.edu/en/index.php>

Key Words: Education, Empowerment, Intellectual, Cognitive, Intelligence, STCW Convention.

Abstract: The need for a new approach in Maritime Education and training (MET) has become essential, competency based training and formal education does not have the same effect on seafarers as it did ten years ago. The vast development in technology and new discoveries in neuroscience are introducing new tracks through which MET systems could be upgraded and enhanced. Considering the mental health of seafarers and developing their cognitive and intellectual capabilities through education, parallel to the application of new lifestyle choices, could upgrade seafarer's mental capacities and intelligence, to be much more efficient in acquiring, memorizing & recalling knowledge, and thus better enable them to take proper decisions to reduce the potential of human error.

1 INTRODUCTION

Statistics of marine accidents trends have shown a decrease in accident rates during the past five years. Mostly, results of accident investigations and researches have declared that human errors have the responsibility of more than 85% of the causes behind marine accidents. Despite the International Maritime Organization's predominant role in the development and amendment of its instrument's to reduce and control that problem. Yet, the human element is still making mistakes that inherently, have the potential to lead to more accidents.

Quoting Einstein, "*We cannot solve our problems with the same thinking we used when we created them*" [2]. The solution cannot be applying the same remedy if the result is not changing; it is time to try a new prospective, or at least approach from a different angle of thought. To enhance marine officer's performance and efficiency, their cognitive and intellectual capabilities have to reach a certain level of intelligence and must be cognitively assessed periodically, empowered & made to benefit from the wealth of knowledge & experience that has become available through technology, modern day communication and new researches in neuroscience.

While Humanware is defined in IT as "*hardware or software that is built around user capabilities and user needs. This often involves creating a particular visual or physical interface for a given set of users*"[22]. However, for the purpose of this

paper, Humanware means “the Mental capabilities of workers especially those working in difficult occupation like seafarers: that could be upgraded or reshaped through education and training to be much more efficient to perform certain tasks properly or increase the cognitive abilities to ensure efficient mental functioning and response. The adaptation of Humanware will be through its internal software (brain plasticity and external software (brain training).

Equally important, mental health is “*the result of the interaction between biological, psychological and social factors and increasing evidence point to work related factors that play a key role in the development of mental health issues in the workplace*”[7]. According to the World Health Organization, key factors include workload, lack of control, monotonous work tasks, role ambiguity, conflict, poor interpersonal relationships, poor working conditions, and inequity [7].

Mental ability represents a person’s “brain power” in different aspects of competency, including verbal, mathematical, spatial, and logical reasoning, which is one of the most important components of functional abilities for a worker [5].

2 MENTAL HEALTH OF SEAFARERS

Seafaring is a high-risk occupation with a unique working environment from the physical and psychosocial point of view. Ships’ crews are facing different challenges that acutely influence their mental health and behavior which include; solitude, dangerous settings, poor working conditions, lengthy periods away from home and family, limited options & free time, poor work relations, lack of shore leaves, intercultural differences and job insecurity, all which have been linked to stress, anxiety, fatigue, depression, alcohol and substance abuse and poor mental health [15].

In addition seafarers are facing latent difficulties in the surrounding working environment they live in for prolonged periods of time such as noise, vibration, temperature changes, electro-magnetic fields and isolation, all of which can be directly related to dangers such as accidents, injuries and diseases [8].

This working environment with its many psychological & physiological variants incorporates many health problems, including suicide, depression, anxiety, alcohol or drug dependence. Psychological health also relates very strongly to many life-style associated health problems found in the other thematic categories; such as cardiovascular disease, diabetes and sexually transmitted disease [16].

Mental sub-health is one of a series of sub-health status, and mainly implies unexplained mental fatigue. The mental sub-health warning mood includes disorders, panic, anxiety, low self-esteem, nervous, reckless, even suicidal thoughts. Seafarers’ mental health status seriously affects the efficiency and the success or failure of their jobs. Such poor mental or psychological state makes them prone to accidents [26].

Psychiatric illness is associated with several specific areas of impairment that may be relevant to work at sea like: impaired information processing ability: attention/concentration, vigilance impaired, visual-spatial functioning with increased latency of motor responses, poor impulse control, including increased risk taking,

poor judgment, including a reduced ability to predict and anticipate reduced problem solving ability, indecisiveness [11].

3 MEDICAL EXAMINATIONS FOR SEAFARERS

Every seafarer holding a competency certificate issued under the provisions of the International Convention on Standards of Training, Certification, Watch keeping for Seafarers Convention (STCW) who is serving at sea must also hold a valid medical certificate issued in accordance with (STCW) regulation I/9 and of section A-I/9 of the STCW Code [10].

Guidelines on seafarers' medical examinations are mainly focusing on vision, hearing and physical standards, where, the mental health requirements are included in brief. These guidelines applied worldwide, with no specific requirements measuring the cognitive and intellectual capabilities of seafarers especially at management level. On the other hand, when reviewing aviation pilot's medical examination standards regarding mental health, it is found that required standards have more comprehensive requirements with regards to mental health, yet still they too do not include specific requirements for cognitive and intellectual capabilities [10].

The Mini-Mental Status Examination (MMSE) is a widely used brief, standardized method for assessing cognitive mental status for aviation Pilots. It allows a gross assessment of orientation, attention, immediate and short-term recall, language, and the ability to follow simple spoken or written commands [9].

4 A SURVEY TO GRANT THE DECLINATION OF COGNITIVE CAPABILITIES INFLUENCED BY SEAFARERS WORKING CONDITIONS AND AGING

A survey of 200 samples have been distributed to candidates attending upgrading studies and mandatory short courses in addition to student's in the final semester for graduation, that they ought to have at least 12 months sea service.

The survey contains only one very simple intelligence quotient (IQ) model to measure the numerical capacity of seafarers at management and operation level and correlate answers to sea service, age and time that has been taken to answer. The Statistical Package for the Social Sciences (IBM-SPSS) software has been used in the statistical analysis of data.

Survey Results were as follows:

Table 1: Results of Survey to measure Link between Age, Sea service and its Impact on Seafarers' Capacity to think and solve Problems in Short Time

| | | | | |
|----------------------------------------------------|-------|-------|-------|-------|
| 96% of samples were answered in one minute or less | | | | |
| Age between | 20-30 | 30-40 | 40-50 | 50-60 |
| Percentage of correct answer | 98% | 94% | 76% | 62% |

From the previous table it is obvious that correct samples of young officers between (20-30) years old with five years sea service or less were 98%. About the same results were detected for those officers with age ranging from (30 to 40) years

old with sea service less than 10 years. For elder officers, the correct answers were dramatically decreased to 76%, for those have age ranging between (40 to 50) years old and reached 62% for those over 50 years old with sea-service exceeding 15 years. Results of the survey clearly indicate that there is a link between marine officer's age, sea service and their cognitive ability and capabilities to solve problems in a short time.

5 COGNITIVE CAPABILITIES AND SKILLS

Cognition is defined as *“all the processes that an organism uses to organize information. This includes cognitive abilities like memory, attention, language, visual and spatial processing, logic and reasoning, interpersonal and intrapersonal reasoning. It has been scientifically proved that cognitive abilities can be improved upon by certain interventions”*[17].

Cognitive capabilities are usually distinguished into two different kinds of intelligences, the fluid intelligence and crystallized intelligence. Fluid intelligence relates to innate abilities that people are genetically endowed with. These include, for example, the ability to reason, the level of comprehension, or the capability of processing information, and are usually not influenced to a great extent by environmental factors. Where crystallized intelligence means the explicitly or implicitly learned knowledge or behavior [21], therefore, it covers any specific knowledge of facts. Unlike fluid intelligence, crystallized intelligence is determined through environmental factors like education or experience. Education improves the crystallized component of cognitive skills, both in the short- and long-term [21], there is evidence that cognitive speed and memory performance decline with age, but that crystallized abilities remain largely intact in those who survive for long-term follow-up [6]. In older ages, fluency or experience with a task can reduce brain activity levels. But, the brain also declines the more we stop using it and with age. Studies have shown that learning can be an effective way to counteract the reduced functioning of the brain [3].

6 BRAIN PLASTICITY (INTERNAL SOFTWARE)

New researches in neuroscience showing that minds still have the opportunity to change and grow cognitively. [13] and [25] defined the brain plasticity as *“the brain's ability to change and adapt as a result of experience, environmental events, and the actions that have been taken, lead to changes in the brain”*. The brain is continually making more connections based on how the individual interacts with the environment. That means humans can influence the rate of cell growth, and can also affect identified factors that enhance or impair neurogenesis. Plasticity can occur as a result of learning, and memory formation, or as a result of damage to the brain.

The brain continues to create new neural pathways and alter existing ones in order to adapt to new experiences, learn new information, and create new memories. The interaction between the environment and genetics also plays a role in shaping the brain's plasticity, then the brain structure and cognitive skills can be improved through an appropriate exercise.

There are two types of neuroplasticity: Functional plasticity in which the brain has the ability to move functions from a damaged area of the brain to other undamaged areas, and the structural plasticity that is the brain's ability to actually

change its physical structure as a result of learning [13]. Neuroplasticity is linked to the concept of competitiveness: if exercising the mental functions is stopped, the corresponding map is automatically assigned to other functions that are continued to play and the past one is forgotten [3].

7 BRAIN BASED EDUCATION

The fault with persons is, not that they have not good minds, that they are not naturally bright, but merely that their minds are not trained, not systematized, not reduced to order. Brain-Based Education (BBE) can be viewed as techniques used to enhance teacher instruction, learning processes and student intellectual and cognitive capabilities. These strategies can also be used to enhance students' ability to learn using ways in which they feel most comfortable, neurologically speaking [4]. The primary goal of the Mind, Brain, and Education field is to join biology, cognitive science, development, and education in order to create a sound base of education. When the brain structural changes occur they alter the functional organization as learning organizes and reorganizes the brain. It was added, that different parts of the brain might be ready to learn at different times [14].

Using of intense emotions associated with competition, or challenge can stimulate the release of adrenaline, which strongly enhances memory in learning. "Challenge, feedback, novelty, and coherence are crucial ingredients for rewiring the brain". A basic component of brain-based learning is that our emotions influence our ability to learn. Our brains are constantly striving to make connections between intellect and emotions [25].

However, learning engages the entire physiology of the body so the brain and the body are engaged in learning. The search for meaning occurs through patterning, and emotions are critical to patterning. The brain processes parts and wholes simultaneously, while learning involves both focused attention and peripheral perception. Learning is enhanced by challenge and inhibited by threat [25].

Repetition of information strengthens connections in the brain and the brain encodes information most efficiently when content is repeated in multiple ways. Active Learning Rather than allowing learners to become passive recipients of information, when people learn by doing, they become energized, they stick with the content, and they learn more. This increases the blood flow around the body, improving learners' memory, retrieval, and confidence [1].

Low energy levels are unavoidable if students remain seated for long periods of time. In BBE environments, role play, energizing online discussions and quick games can all add sensory stimuli to raise blood pressure and adrenalin levels to eliminate drowsiness, reduce restlessness, and reinforce information. Allowing learners to do some exercises on their own to better understand abstract ideas, write an essay or work with an interactive simulation are also helpful strategies [1].

When learners see something new, dopamine levels increase in the brain as students know the stimuli has the potential to reward them in some way. This motivates learners to seek out the reward. There are a huge number of opportunities to introduce novelty in courses simply by being creative; for instance, developers can use fresh examples, surprise learners with new data or present a scenario that's

completely unpredictable. Or, even engage students through games and simulations that require learners to apply the information in unfamiliar contexts [1].

However, the Principles of Brain-Based Learning could be summarized as: the brain is in parallel a processor performing many tasks simultaneously, including thinking and feeling.

8 MENTAL TRAINING (EXTERNAL SOFTWARE)

General mental activities, can improve performance, as well as long-term mental health, while relaxations techniques help to regulate the activation of brain. There are two aims of developing humanware cognitive capabilities, by enhancing learner mental capacities and properly utilize knowledge, skills and proficiencies.

Mental training consists of learning strategies to memorize information while tackling brain's spatial navigation system to remember objects or propositional contents. There are various other methods for memory enhancements such as use of rhyming, recalling colorful or emotional scenes, recalling number series or letters and studding in groups [17]. On the other hand, to enhance learner mental capacities, learners should be engaged in problem solving cases, root causes analysis, and using video games/virtual/augmented reality (V/AR) modules.

9 CONCLUSIONS

Despite efforts taken by the maritime industry stakeholder's to eliminate accidents at sea, the human factor remains the main cause of marine accidents. Maritime education and training systems still mainly depend on competency-based training without any interest in the intellectual and cognitive capacities of officers – especially - at management level.

Brain-based learning can enhance education and training efficiencies and on the other hand enhance student intellectual and cognitive capabilities, thus improve the reception of knowledge and develop the mental performance of students to become better equipped and able to make the right decision and minimize human error thus reducing accidents tally as well as their potential.

10 RECOMMENDATIONS

- 1- It is necessary to change the consolidated mental attitudes about learning and about teaching, bearing in mind the complexity of the new hybrid, ubiquitous and liquid learning scenarios.
- 2- Transform old educational models to new, more flexible & creative models that reflect the mental capacities of students.
- 3- Build on new methodologies in teaching to use newly established fact-finding models (such as the iceberg model, fault tree and accident pyramid) to assist in creating databases of real life events.
- 4- Fully exploit modern day familiarity with all digital gadgets, as well as their relative affordable-ness to create real life scenarios utilizing modern day technologies and concepts such as artificial intelligence (AI) and virtual/augmented reality (V/AR) modules to enhance their mental capabilities and intellectual skills in real-time and in their local environments.

- 5- Officers at management level should undergo mental intellectual profiling/mapping to determine whether they are capable of demonstrating the cognitive, emotional and environmental capabilities required for their positions. This testing should be further enforced by periodic checks on a scheduled, structured basis.
- 6- Refresher courses should be administered for cognitive and intellectual capacities every two years.
- 7- On-board training and exercising should be enforced and inspected.
- 8- Learning Environment to be brought to the fore-front to allow the shaping of student achievement as learning is enhanced when the environment accommodates the needs of the learner and the instructor.

REFERENCES

- [1] SH!FT, 2018. "A List of Brain-based Strategies to Create Effective eLearning ". Articles on brain-based learning. [viewed date 2September 2018] available from: <https://www.shiftlearning.com/blog/bid/354359/a-list-of-brain-based-strategies-to-create-effective-elearning>
- [2] *Brainy Quote*, 2018. " *Albert Einstein Quotes*". Albert Einstein. .[viewed date 12 May 2018] available from: https://www.brainyquote.com/quotes/albert_einstein_121993
- [3] CERI, 2008. "Understanding the Brain: The brain of learning Science". OECD/CERI International Conference "Learning in the 21st Century: Research, Innovation and Policy" . Center for Educational Research and Innovation. .[viewed date 18 May 2018] available from: <https://www.oecd.org/site/educeri21st/40554190.pdf>
- [4] Eric P. Jensen, 2009. "A Fresh Look at Brain-Based Education". PDK International | Phi Delta Kappan: Jensen V89 N6 pp 408-417. .[viewed date 10 May 2018] available from: <http://jotamac.typepad.com/files/brain-based-education-feb-2008.pdf>
- [5] Fei ZHONG1, 2, Eiji YANO, et. al. 2006. Mental Ability and Psychological Work Performance in Chinese Workers. *Industrial Health* 2006, 44, 598–603. .[viewed date 12 May 2018] available from: <https://pdfs.semanticscholar.org/b839/d7f2c295ecc2b242bbc82a84338b48bceb1e.pdf>
- [6] Helen Christensen, 2018, "What Cognitive Changes can be Expected with Normal Ageing?". SAGE journals. The Royal Australian and New Zealand College of Psychiatrists. Australian & New Zealand Journal of Psychiatry ISSN: 0004-8674. Research article.[viewed date 16May 2018] available from: <http://journals.sagepub.com/doi/abs/10.1046/j.1440-1614.2001.00966.x>
- [7] I.M.E.Q, 2017. "Psychology At Sea". Online Magazine For Seafarers. Seafaring and Mental Health Issues.[viewed date 11 April 2018] available from: <https://www.imeq-magazine.com/single-post/2017/07/24/Seafaring-and-Mental-Health-Issues>
- [8] I.M.E.Q, 2018. "Psychology at Sea". Online magazine for seafarers. [viewed date 22 May 2018] available from: <https://www.imeq-magazine.com/single-post/2017/07/24/Seafaring-and-Mental-Health-Issues>
- [9] International Civil Aviation Organization, 2012." Manual of Civil Aviation Medicine". International Civil Aviation Organization. Doc 8984 AN/895. Third Edition-2012.[viewed date 22 May 2018] available from: https://www.icao.int/publications/Documents/8984_cons_en.pdf
- [10] International Labour Organization, and, International Maritime Organization, 2012. "Guidelines on the medical examinations of seafarers". International labour Organization, International Maritime Organization. Sectoral Activities Program. .[viewed date 22 May 2018] available from: <http://www.ics-shipping.org/docs/default-source/ILO-MLC-docs/ilo-imo-guidelines-on-the-medical-examinations-of-seafarers.pdf?sfvrsn=4>
- [11] International Transportation Fedration, 2018. Mental disorders, including cognitive and behavioral impairment, alcohol and substance misuse (ILO/IMO Guidelines Appendix E F00-99). Handbook for seafarer medical examiner (chapter 14). .[viewed date 4 May 2018] available from: <http://handbook.ncmm.no/index.php/mental-disorders-including-cognitive-and-behavioural-impairment-alcohol-and-substance-misuse>

- [12] John D. Bransford, et.al, 2001. "How People Learn: Brain, Mind, Experience, and School". Commission on behavioral social science and education. Washington, D.C. .[viewed date 12 May 2018] available from: [:https://www.nap.edu/read/9853/chapter/8#115](https://www.nap.edu/read/9853/chapter/8#115)
- [13] Kendra Cherry, 2018. "What Is Brain Plasticity? How Experience Changes the Brain". Very well Mind. .[viewed date 12 April 2018] available from <https://www.verywellmind.com/what-is-brain-plasticity-2794886>
- [14] Kurt W. Fischer, 2009. "Mind, Brain, and Education: Building a Scientific Groundwork for Learning and Teaching". International Mind, Brain, and Education Society and Wiley Periodicals, Inc. Volume 3 number 1. [viewed date 3 May 2018] available from <https://www.gse.harvard.edu/~ddl/articlesCopy/FischerGroundwork.MBE2009.3.1.pdf>
- [15] LinkedIn, 2016. "Mental health of Seafarers & Disorders Associated". Innovative Maritime EQ Center. Psychology and Maritime Center at I.M.E.Q. [viewed date 2 May 2018] available from: <https://www.linkedin.com/pulse/mental-health-seafarers-disorders-associated-i-m-e-q/>
- [16] MacLachlan et. al.²³, 2013. "Psychosocial Maritime Health". Journal of International Maritime Health. ISSN: 1641-9251. .[viewed date 8 May 2018] available from:[Khttp://textbook.ncmm.no/index.php/textbook-of-maritime-medicine/21-textbook-of-maritime-medicine/28-psychosocial-and-organisational-aspects/799-psychosocial-maritime-health](http://textbook.ncmm.no/index.php/textbook-of-maritime-medicine/21-textbook-of-maritime-medicine/28-psychosocial-and-organisational-aspects/799-psychosocial-maritime-health)
- [17] Mandeep Singh and Mahak Narang, (2014). "Cognitive enhancement Techniques". Department of Electrical & Instrumentation Engineering, Thapar University, Patiala, INDIAIJITKMI Volume 7 - Number 2 - pp. 49-61 (ISSN 0973-4414) .[viewed date 11 May 2018] available from: <http://www.csjournals.com/IJITKM/PDF%207-2/10.%20Mahak.pdf>
- [18] Maritime and Coastguard agency, 2014. "Seafarer Medical Examination System and Medical and Eyesight Standards: Application of the Merchant Shipping (Maritime Labour Convention)(Medical Certification) Regulations 2010". Maritime &Coastguard Agency. Merchant Shipping Agency MSN 1839 (M). [viewed date 6 May 2018] available from https://assets.publishing.service.gov.uk/government/uploads/system/uploads/attachment_data/
- [19] Mirjam van den Berg, 2015. "Improving education starts with improving knowledge of the brain". TEDxAmsterdamED. Speech. .[viewed date 7 May 2018] available from: <http://tedxamsterdam.nl/improving-education-starts-with-improving-knowledge-of-the-brain>
- [20] Norwegian Maritime Authority, 2014. " "New Regulations on the medical examination of employees on Norwegian ships and mobile offshore units ". Journal No.: 2012/22925alg . .[viewed date 9 May 2018] available from: <https://www.sdir.no/contentassets/f5419feaa6b749469a5d44a92c99e371/rsr-02-2014-medical-examination.pdf?t=1525891681401>
- [21] Sarah C. Dahmann, 2016. "How Does Education Improve Cognitive Skills? Instructional Time versus Timing of Instruction". The German Socio-Economic Panel study at DIW Berlin. .[viewed date 5 May 2018] available from: http://conference.iza.org/conference_files/SUMS_2016/dahmann_s10188.pdf
- [22] Techopedia, 2018. "Definition". The IT Education Site. .[viewed date 12 May 2018] available from: <https://www.techopedia.com/definition/623/humanware>
- [23] US Coastguards, 2018. "Medical Fitness for Certification". National Maritime Center. [viewed date 6 May 2018] available from: https://www.ecfr.gov/cgi-bin/text-idx?c=ecfr&sid=ae63e8c8b8556b036cfde87e4a7bb8de&rgn=div5&view=text&node=46:1.0.1.2.10&idno=46#se46.1.10_1302
- [24] Versen RT, 2012. "The Mental Health of Seafarers". US National Library of Medicine. National Institutes of health. .[viewed date 13 May 2018] available from: <https://www.ncbi.nlm.nih.gov/pubmed/22972547>
- [25] Virginia Bonomo Ed. D, 2017. "Brain-Based Learning Theory". Journal of Education and Human Development, Vol. 6, No. 1, pp. 27-43 ISSN: 2334-2978 (Online). Bloomsburg University. .[viewed date 14 May 2018] available from: http://jehdnet.com/journals/jehd/Vol_6_No_1_March_2017/3.pdf
- [26] Yingchao Shi, Weiming Zeng, et. al. 2015. " Early warning for human mental sub-health based on fMRI data analysis: an example from a seafarers' resting-data study". US national Library of Medicine. National Institute of Health.[viewed date 22 May 2018] available from: <https://www.ncbi.nlm.nih.gov/pmc/articles/PMC4511829/>.

EDUCATING THE FUTURE MARITIME WORKFORCE IN A SEA OF CONSTANT DISRUPTERS AND CHANGE

MICHAEL A. ALFULTIS, PH.D

President

State University of New York Maritime College
6 Pennyfield Avenue Throggs Neck NY 10465

e-mail: malfultis@sunymaritime.edu web page: <http://www.sunymaritime.edu>

Keywords: Maritime Education; Maritime Training

Abstract. This paper considers how technological change, and the rate of that change, will impact maritime education and training and our graduates. Changes in technology, the environment, the regulatory picture and globalization represent a more complex array of forces for our students to understand than ever before. Students can no longer assume that acquired technical skills will serve the demands of their rapidly changing workplaces. These changes and challenges require maritime universities to elevate our academic programs, ensure our curricula remain relevant, and provide our students with tools and adaptive skill sets they will need to become life-long learners. This will require maritime universities to conduct an “environmental scan” of the world and environments in which they operate, and interpret relevant external factors and trends. As an example, the author provides a scan of the maritime industry, its impact on maritime education and training programs, and recommendations on how maritime universities can adapt in an age of “accelerated change.”

1 INTRODUCTION

Today, technology and globalization are driving the greatest changes in the maritime industry since the shift from sails to steam over 150 years ago. Disruptors include: digitization and data analytics; systems integration and automation; e-commerce; new technologies; and, environmental regulations. These same forces are affecting every sector of the maritime industry for which we prepare students, as well as the world of higher education.

How is the challenge of constant change for the current and future generations of students and mariners different from that of previous generations? I believe New York Times columnist and best-selling author Thomas Friedman describes it best in his book *Thank You for Being Late: An Optimist's guide to Thriving in the Age of Accelerations*. Friedman says it is the dizzy pace of simultaneous and accelerating change in three different but interconnected realms: the market; Mother Nature; and Moore's law [1]. The market refers to globalization which is causing the world to be “hyper-connected” and more interdependent. Mother Nature is climate change, biodiversity loss, and population growth. Moore's law states that the power of microchips will double every 24 months. The impact of these interconnected realms is that technological change is accelerating so fast that, unlike in the past, people, regulations,

and educational institutions can no longer keep pace. We are now in what Freidman refers to as the “age of accelerations” [1].

2 EDUCATING THE MARITIME WORKFORCE IN THE “AGE OF ACCELERATIONS”

Given we are in a new age of accelerations, how do we graduate students who have the adaptive skills and tools necessary to succeed in the industries of today and the future? Changes in technology, the environment, the regulatory picture and globalization represent a more complex array of forces for our students to understand than ever before. Students can no longer assume that technical skills they acquire at the university will serve the demands of a rapidly changing world. More than ever, students need to learn the flexibility, adaptability and entrepreneurship that will prepare them for changes to the maritime industry in which they will work and for many different jobs they are likely to hold. This means our institutions must graduate students who can adapt, retool, and re-learn throughout their careers. In other words, they must be life-long learners.

We can only do this through a balance of education and training. Education provides the theoretical foundation and promotes intellectual and personal growth in areas such as: critical thinking and analysis; quantitative and scientific reasoning; information literacy; communication skills; leadership and ethics; appreciation for global civilizations and the natural world; and competency in a field of study. Training refers to skills and knowledge that relate to specific useful competencies. Training prepares students for a current job, while education prepares them for a career.

Our students and graduates must have access to education and training that is relevant. Our institutions must have processes in place that, through meaningful partnerships with the industries we serve, ensure our courses and programs are germane. We have been familiar for decades with the term “just in time logistics”. We must now adapt this same concept to our institutions and offer “just in time education and training.” However, we must do more than just react to accelerating changes we must anticipate them. Our institutions must be more agile. Supporting Friedman’s concept of accelerating change, Eric “Astro” Teller, Chief Executive Officer (CEO) of Google’s X research and development suggests that today with shorter and shorter innovation cycles and less and less time to adapt, “the time of static stability has passed us by...the new type of stability is dynamic stability.” He likens this to riding a bicycle, “where you cannot stand still, but once you are moving it is actually easier” [1]. This might be easy to say, but how do we do this when it comes to maritime training and education? How do we learn to operate in an environment of “dynamic stability?” First, we must know where we are going on the bicycle. We must anticipate future trends and the impacts of those trends.

3 ENVIRONMENTAL SCAN: ANTICIPATING FUTURE TRENDS AND IMPACTS

A useful tool for anticipating future trends and impacts is an “environmental scan.” This process systematically surveys and interprets relevant data to identify external opportunities and threats. Typically, institutions and organizations conduct an environmental scan as part

of a five to ten year strategic plan. However, in a world of accelerating change, scanning must be a continuous process that enables us to anticipate and react to change.

In undertaking an environmental scan, maritime universities must identify the various environments that may impact them and define the period of time the scan will consider. While it is important to define a period for the scan (5, 10, 15 years), in some cases real change that will affect our students and future graduates may be outside the selected period. However, these changes may start to demonstrate emergence within the period of the scan.

For example, while most industry experts agree that ships and our logistic systems will become increasingly automated and integrated, completely autonomous ships and ports may not emerge on a large scale for decades. However, systems onboard current vessels and new builds will become increasingly automated, integrated, and in some cases autonomous. Therefore, while we may not set up a program for an autonomous mariner license today, we must infuse new technologies and technical fluency across the curriculum so our graduates can operate in a more integrated and autonomous environment.

What common environments or areas should a scan for maritime universities consider? In preparation for State University of New York (SUNY) Maritime College's new strategic plan, we looked at six areas: world trends; technology; energy; maritime industry; higher education; and the area of maritime education and training. While these may be common areas for all IAMU members, the implications of the scan will differ for each institution based on geography, political concerns, national regulations, economic considerations, unique institution missions and considerations, and regional competitors. The scope of this paper will be limited to the scan of maritime industry and its impact on maritime education and training. However, as the aforementioned environmental areas are inter-related, we will include the relevant trends and impacts from the other environmental areas especially as they relate to maritime industry over the next decade

4 MARITIME INDUSTRY TRENDS AND IMPACTS ON EDUCATION AND TRAINING

The integration of digital technologies into everyday life – digitalization – is reshaping every aspect of our lives and business. The development of sensor technologies and smart technologies will continue to accelerate. Just look at the how our automobiles have become mobile data vacuums that can track everything from the weight of the passengers, to what we listen, to whom we call, to diagnostic information. Machine learning is being incorporated into everyday technologies. Along with these advances, data analytics by sophisticated computers and programs will enable the development of autonomous systems that are situationally aware, capable of making decisions and adept at learning. The connectivity of systems will improve with ubiquitous communications systems.

As such, there is consensus that there will be a steady progression to autonomous (i.e. self-learning, integrated intelligent) systems for ships with the goal of autonomous ships in the future. This will mean a reduction in crew sizes and a shift where licensed mariners are required in order to operate ships safely in autonomous and manual modes. A more digital and tech savvy crew and maritime workforce will be required onboard and ashore. The nature of licenses is expected to change with a demand for relevantly new licenses, such as the Electro Technical Officer credential, or new credentials for remote operation of ships.

Just like other industries where technology has eliminated jobs, the overall number of jobs for mariners could actually increase due to increased volumes of shipping traffic associated with an expected increase in world Gross Domestic Product (GDP). However, different skill sets and credentials will be associated with these new jobs. We need not fear automation. A Deloitte study of job automation by U.K. industries found that over a 15-year period 800,000 low-skilled jobs were eliminated as the result of artificial intelligence (AI) and other automation technologies, while 3.5 million new jobs were created. These new jobs paid on average \$13,000 more per year than the ones that were lost. The study went on to conclude: “continued success will rest on the ability of businesses and organisations, educators and government to correctly anticipate future skills requirements and provide the right training and education” [2].

The ongoing transition from manual and automatic to autonomous systems over the next decade will result in increasingly complex systems. More integrated and complex cyber systems will require cyber resiliency against malicious or inadvertent attacks for all sectors of the maritime industry including ship and terminal operations, brokering, chartering, protection and indemnity (P&I), ship registry and supply chain management. Part of the solution to providing security for complex systems includes block-chain technology. Two years ago, not many people were talking about blockchain technology and were incorrectly assuming that it was the same thing as the crypto currency Bitcoin. After the June 2017 cyberattack that cost Maersk as much as \$300 million and disrupted operations for 2 weeks, there was an accelerated interest in blockchain technology. IBM and AP Moller-Maersk set up a joint blockchain venture to make the company’s supply chain more efficient and secure [3].

Cyber threats, and new technologies such as blockchain, will drive the need for a digital maritime workforce having new certificates/credentials. Anticipating this need, at SUNY Maritime College we recently incorporated a multi-discipline team-taught undergraduate cybersecurity course which involves five of our academic departments. For graduate students we are in the process of building a two course certificate program. These undergraduate and graduate courses focus on the cybersecurity threat in the maritime environment and include a familiarization with blockchain technology. But even before we were working to develop a formal curriculum to incorporate cybersecurity and blockchain into our curricula, our student computer club was already embracing this technology, participating in sponsored port hacking exercises and learning more about blockchain technology. I would suggest it is skills such as critical thinking and creativity, provided through a well-rounded education, which gave them the drive to explore and learn these new digital technologies even without a formal program in place.

Beyond technological changes, there are energy and environmental trends to consider. The world population is expected to grow from 7.5 billion in 2017 to 8.5 billion by 2030. Africa and Asia will experience the largest growth and comprise the largest percentage of the world population [4]. With this growth, it is estimated that 20% more energy will be consumed. Although fossil fuels will still be a significant part of the energy mix, natural gas and renewables will contribute more. Significant advances and reduced costs will occur in renewable energy technology such as wind, solar photovoltaic (PV) and ocean current/tidal energy. With an increase in offshore renewable energy in the next decade, a demand will arise for specialized workforce and ships to build and maintain offshore renewable energy platforms, mariners to operate those ships, and offshore energy technicians and renewable

energy plant operators. How are we as maritime universities prepared to meet this new workforce demand? SUNY Maritime College is in the process of establishing an Off-Shore Renewable Energy Center of Excellence to partner with industry and establish new programs that will meet their future workforce requirements.

Shipping will become greener and more fuel-efficient. According to DNV GL, “the growth in liquid natural gas (LNG) powered ships is expected to accelerate towards 2025.” In 2017, there were about 75 LNG powered ships in operation (excluding LNG carriers), and another 80 are under construction. Additionally, 40 ships have been designed to be ready for an LNG retrofit [5]. In response to the growth of LNG powered ships, SUNY Maritime is establishing an LNG Center of Excellence, with a similar purpose as the aforementioned off-shore center of excellence. Recent developments in ship propulsion electrification, new battery storage technologies and hybrid-electric solutions on smaller vessels could be the harbinger for some degree of hybridization on larger vessels in the next decade. Sources estimate that by 2025 a majority of larger vessels could have some degree of hybridization [5]

As with all technological changes, views vary on the rate of the adoption. Automated ships and ports require a large capital investment. With the surplus of tonnage on the market today, this could slow new capital investment in more automated or autonomous ships. International Standards of Training, Certification, and Watching-Keeping (STCW), and national laws and regulations which are based on those standards, will need to be changed to permit crew reduction sizes associated with more automated or autonomous operation. There is a reluctance of ship and terminal owners to “be the first” before regulations have fully evolved and industry standards have been defined/adopted. The same is true of ships with newer types of propulsion. On the shore side, labor unions will continue to slow the adoption of automation, due to the potential loss of jobs for their members.

5 CONCLUSION: WE NEED TO CHANGE COURSE

So how do we respond as maritime universities to this sea of constant disruptors and change? First, we need to conduct consistent and meaningful assessment of our academic and training programs to ensure quality and relevance. Given that technology is advancing at an exponential rate and outstripping current workforce capability, our environmental scan and assessment of current programs need to help us anticipate required changes in our curricula and develop new credentials/certifications that will be required by the maritime industry. This will necessitate:

- faculty capable of integrating technology into the classroom;
- close partnerships with industry;
- applied learning opportunities and internships that introduce students to the latest technology;
- similarly, more opportunities for faculty-industry interactions; and
- increased faculty-student research opportunities.

Relevance will also require our program and course review processes to change. While shared governance is essential, the process of revising and updating curricula must move from static stability to dynamic stability. As the rate of technological change increases, we must establish new processes that enable us to evolve, change, and deliver “just-in-time” programs

and courses.

In order to adopt this model, we will need to frequently scan the horizon, determine what DVG-GL refers to as the most probable future, and understand that while there will be significant uncertainties, we should be able to make decisions, and equally important assess them, based on current trends in a relatively short period [5].

For example, Google needed a course after they released basic algorithms for an open source program called TensorFlow in October 2015. Udacity, working directly with Google engineers, was able to develop and put online a course by January 2016. Friedman calls this “jump starting the curriculum.” Traditional universities would find this nearly impossible under current academic structures[1]. In short, our institutions need to become more agile.

Second, our students will also need to become more agile. We must identify the current and future adaptive skillsets necessary for our graduates to succeed in the job market of today and thrive in the industries of tomorrow. This will required us to carefully balance and integrate education and training, infusing these important themes and skillsets across our curricula. In short, we must integrate knowledge in a discipline (major), hands-on learning experiences, and adaptive skills from across a program of studies in liberal arts and Science Technology Engineering and Math (STEM) disciplines. In this way, we will provide graduates not only immediate employability in a competitive career field but also the character, adaptability and ingenuity to succeed throughout their careers as the nature of the industry changes rapidly^[WM1].

Finally, recognizing the maritime industry is a global industry there must be closer and more frequent collaboration among IAMU institutions. Our students and faculty need to be more aware of the geo-political, international, and economic factors that drive the maritime industry. This will require increased opportunities for study abroad, international internships, and faculty exchanges.

There will be inertia internally and externally to these needed changes. However, not to acknowledge that change is required will not serve our students or the maritime industry well.

REFERENCES

[1] Friedman, T. L. *Thank You for Being Late: An Optimist's Guide to Thriving in an Age of Accelerations*. New York: Farrar, Straus and Giroux, 2016. ISBN 978-0-374-27353-8.

[2] Delloitte. *From Brawn to Brains: The Impact of Technology on Jobs in the UK*. London: Delloitte. 2015.

[3] Miline R. *AP Moller-Maersk and IBM To Use Blockchain in Global Trade*. Financial Times 16 Jan 2018. Available from <<https://www.ft.co>>

[4] United Nations Department of Economic and Social Affairs Population Division. *World Population Prospects: The 2017 Revision, Key Findings and Advance Tables*. 2017. Available from <<http://www.un.org>>

[5] DNV.GL. *Technology Outlook 2025*. DNV GL. 2016, p.46; p.1 Available from [<https://www.dnvgl.com/>](https://www.dnvgl.com/)

Enhanced Fast-Time-Simulation Features to support Ship-Handling Simulator Training

K. Benedict, M. Gluch, M. Kirchhoff, M. Schaub, G. Tuschling*

M. Baldauf^{}, M. Gehrke^{***}**

* University of Applied Sciences Wismar, Dept. of Maritime Studies, ISSIMS Institute
R.-Wagnerstr. 31, Rostock-Warnemuende / Germany
Email: knud.benedict@hs-wismar.de, <https://fiw.hs-wismar.de/bereiche/sf/forschung/>

** World Maritime University, Fiskehamnsgatan 1, 20124 Malmö / Sweden
Email: mbf@wmu.se, <https://www.wmu.se/>

*** MarineSoft / benntec Systemtechnik GmbH,
Friedrich-Barnewitz-Str.11, D-18119 Rostock / Germany
(mario.gehrke@benntec.de, www.marinesoft.de)

Abstract: New technologies as Fast Time Simulation (FTS) have great potential for teaching and learning in the maritime training environment and for use on board of ships. New concepts for training application of these innovative technologies have been developed at Maritime Simulation Centre Warnemunde MSCW / ISSIMS Institute in research projects. The innovation is to simulate the ships motion with complex dynamic models in fast time and to display the ships track immediately for the intended or actual rudder or engine manoeuvre, steered by a smart interface. These simulations allow for new type of manoeuvring design and optimisation of not only the next manoeuvring segment ahead but also for the following or even for series of manoeuvring segments. One obvious basic advantage in relation to conventional ship-handling training and navigators' preparation of harbour approaches is the easy creation, visualization and comparability of different manoeuvring strategies.

The FTS software system consists of various modules for (a) Manoeuvring Design & Planning, (b) Monitoring & Conning based on Multiple Dynamic Prediction, (c) Trial & Training and (d) Replay and Assessment. Specifically the Planning module is the missing link in Voyage planning because it allows to develop the concept of specifically the manoeuvres in the unsteady motion segment after entering the moles up to the final berthing manoeuvre –

and even to try out alternatives and limits of environmental effects. For practical application the new FTS-features were interfaced to the new Full-Mission and Desktop ship handling simulator Systems, configured by MarineSoft / benntec, based on Rheinmetall RME bridge simulator software ANS 6000.

During recent research activities it became obvious that the new FTS technology has great potential for teaching and learning in the maritime education, both for lecturing and for simulator training in briefing and debriefing sessions of exercises, to make ship handling exercises more efficient and valuable for all parties. Experiences have been made how this new technology can be used to improve the simulator training in the Advanced Ship Handling Training course at the World Maritime University, Malmoe / Sweden [12], at the Maritime Simulation Centre of AIDA Cruises at Rostock /Germany and at the CSMART Centre for Simulator Maritime Training of Carnival Corporation at Almere /NL. In addition to ship handling training, the combination of ANS and FTS can be used in port risk assessments and in harbour and waterway design studies.

Samples of application for briefing / debriefing and introduction lectures for simulator exercises specifically for typical cruises ships with Twin-Screw and -Rudder systems will be shown in the paper and at the conference. The potential of this technology for advanced maritime education and training will be discussed.

Keywords: Simulation, ship handling, training, voyage planning, optimising manoeuvring concepts

1. DESCRIPTION OF THE CONCEPT FOR USING THE FAST TIME SIMULATION (FTS) WITH A FULL MISSION SHIP HANDLING SIMULATOR (SHS)

1.1 Need for Fast Time Simulation (FTS) and manoeuvring support in SHS

Full mission Ship Handling Simulators (SHS) have to cover all training requirements on many areas: navigation, communication, resource management and last but not at least to manoeuvre a ship based on the mental model of the ship motion characteristics. Because in the SHS the simulation is in real time, all training processes are very time consuming and e.g. learning manoeuvring by Trial and Error turned out to be very costly. Therefore, the idea of Fast Time Manoeuvring Simulation was born - to present the outcome of certain rudder, thruster or engine commands in shorter time – and even more to allow for designing a full manoeuvring plan! For lecturing and familiarisation FTS plays the role of an “Electronic Smart Manoeuvring Booklet” which can answer any question on manoeuvring condition immediately and not only restricted to the standard manoeuvres in the conventional paper form booklet.

For voyage planning the IMO requires the complete distance from “Berth-to-Berth”. These plans are an important element in training to form a mental model in the trainee’s brain of the ships’ manoeuvring behaviour up to the full concept for a manoeuvring strategy (and later on-board they are necessary to agree on a concept within the bridge team and also for the discussion and briefing with the pilot). But even in training in a simulator, there is no electronic tool to quickly demonstrate manoeuvring characteristics or moreover to efficiently design a

manoeuvring plan effectively for port arrival or departure. The plan for the potential manoeuvres is still developed in a contemplative way by thinking ahead – only drafted on paper or described by self-made sketches and short explanations. Manoeuvring characteristic data are available still on paper only for calm water, impact of wind or current can be taken into account on rather vague estimations based on experiences or pure guessing. The plans are made by hand on paper charts or on a printout of electronic chart interface – by now there is no tool available to provide support for manoeuvring planning yet.

For increasing the quality and effectiveness of ship handling training and also the safety and efficiency for manoeuvring real ships the method of Fast Time Simulation will be used and has a great potential for future.

1.2 Overview on the software modules for the Fast Time Simulation (FTS) in the SAMMON system and interface with the ANS 6000 SHS

These Fast Time Simulation tools were initiated in research activities of the Institute for Innovative Ship Simulation and Maritime System (ISSIMS) at the Maritime Simulation Centre Warnemuende, which is a part of the Department of Maritime Studies of Hochschule Wismar, University of Applied Sciences - Technology, Business & Design in Germany. They have been further developed in close cooperation by the start-up company Innovative Ship Simulation and Maritime Systems (ISSIMS GmbH, <http://www.issims-gmbh.com>). Even with standard computers it can be achieved by the new methods to simulate in 1 second computing time a manoeuvre lasting to 24 min using innovative simulation methods. The FTS software is interfaced with the SHS ANS 6000 (ANS - Advanced Navigation Simulator) of Rheinmetall Electronics GmbH as shown in Fig. 1.

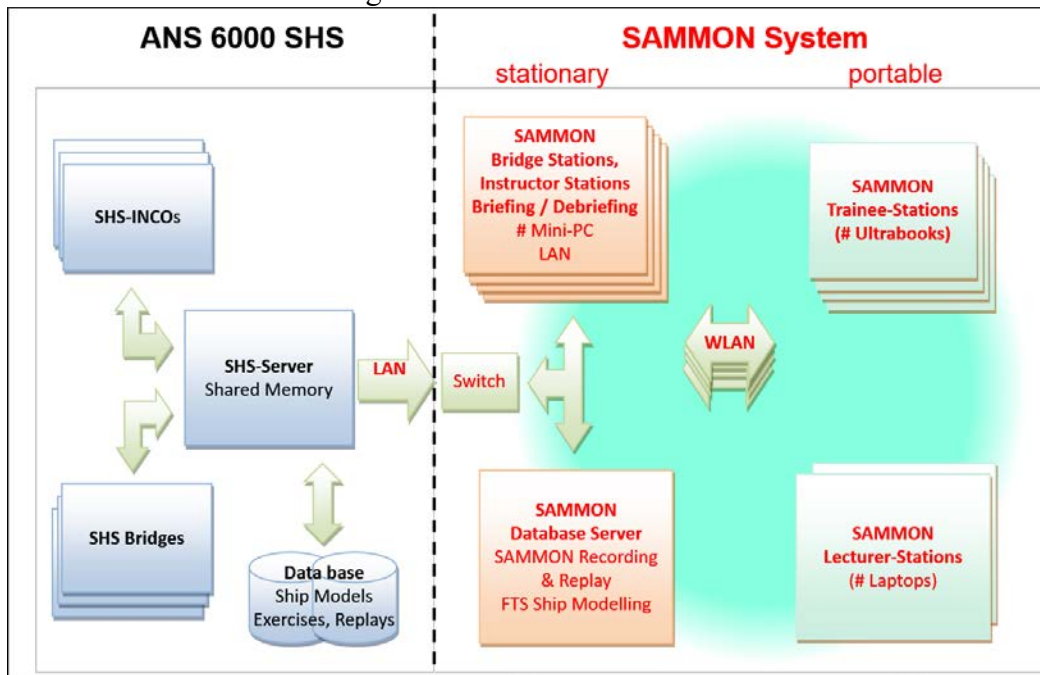

Fig. 1 The Fast Time Simulation System for Simulation-Augmented Manoeuvring Design, Monitoring & Conning - SAMMON is fully integrated to the ANS 6000 by a smart interface using LAN and WLAN.

The SAMMON system has access to ANS 6000 Database and process data are communicated through Shared Memory and SHS Server via LAN. SAMMON uses LAN for stationary workplaces and WLAN for connecting portable stations to any exercise / bridge and replay.

The Ship Handling Simulator series manufactured and distributed by MarineSoft is a high-performance and high-quality system based on the Rheinmetall Electronics ANS 6000 with DISIXtreme visualization. The system is based on realistic behaviour due to integration of original hydrodynamic data of ships and environmental physics. The system is operated in academies and training centres as well as research institutes around the world. The bridge configuration is shown in Fig. 2 with samples for the additional elements of the FTS functionality.



Fig. 2 ANS 6000 bridge simulator with Fast Time Simulation System for Simulation-Augmented Manoeuvring Design, Monitoring & Conning - SAMMON is fully integrated to the ANS 6000 by a smart interface using LAN and WLAN

- Left: Bridge simulator overview with SAMMON Planning station (right) and instructor station (left) in the foreground, manoeuvring console with displays and visual system in the background
- Right: Manoeuvring console with handles and screens with Monitoring Tool display on the left side

A brief overview is given for the modules of the FTS tools and its potential application: SAMMON is the brand name of the innovative FTS system for “Simulation Augmented Manoeuvring – Design, Monitoring & Conning”, consisting of four software modules for Manoeuvring Design & Planning, Monitoring & Conning with Multiple Dynamic Prediction and for Simulation Trial & Training and for Replay & Assessment:

- Manoeuvring Design & Planning Module: Design of Ships Manoeuvring Concepts as “Manoeuvring Plan” for Harbour Approach and Berthing Manoeuvres (steered by virtual handles on screen by the mariner)
- Manoeuvring Monitoring & Conning Module with Multiple Dynamic Manoeuvring Prediction: Monitoring of Ships Manoeuvres during Simulator Exercises or Manoeuvres on a Real Ship using bridges handles, Display of Manoeuvring Plan and Predicted Manoeuvres in parallel; Calculation of various prediction tracks for full ships dynamic Simulation and Simplified Path prediction as Look Ahead for the future ships motion.
- Manoeuvring Simulation Trial & Training Module: Ship Handling Simulation on Laptop Display to check and train the manoeuvring concept (providing the same functions as Monitoring tool; steered by virtual handles on screen)

- Recordings of scenarios from training sessions or from real ship voyage data recordings can be replayed together with the multiple prediction for assessment of the performance

SIMOPT is a Simulation Optimiser software module based on FTS for optimising Standard Manoeuvres and modifying ship math model parameters both for the ANS 6000 simulator ships and at the same time for the FTS Simulation Training Systems - and in future for on board application of the SAMMON System.

SIMDAT is a software module for analysing simulation results both from simulations in SHS or SIMOPT and from real ship trials: the data for manoeuvring characteristics can be automatically retrieved and comfortable graphic tools are available for displaying, comparing and assessing the results.

The SIMOPT and SIMDAT modules were described in [2] [7] for tuning of simulator ship model parameters and also the modules for Multiple Dynamic Prediction & Control, [5] for the on board use as steering assistance tool [6] [3] [4]. In this paper, the focus will be laid on the potential of the SAMMON software for supporting the lecturing and briefing / debriefing process with elements specifically for simulator training with the ANS 6000 for Advanced Ship Handling as it has been done in the MSCW and in the Maritime Simulation & Training Centre MSTC of the AIDA Cruises Company at Rostock / Germany.

2. USE OF FTS FOR BRIEFING

2.1 Task description – introduction, conventional Briefing and NEW CONCEPT

During the exercise briefing, the navigational officer is introduced into the ship manoeuvring characteristics, e.g. using the Manoeuvring Booklet, the harbour area, the starting situation and the environmental conditions within this area on a conventional sea chart, Fig. 3. The objective is to bring the ship through the fairway channel of Rostock Port from North, to turn the ship into the East channel and to berth the ship with Port Side at the Pier in the Southern basin.

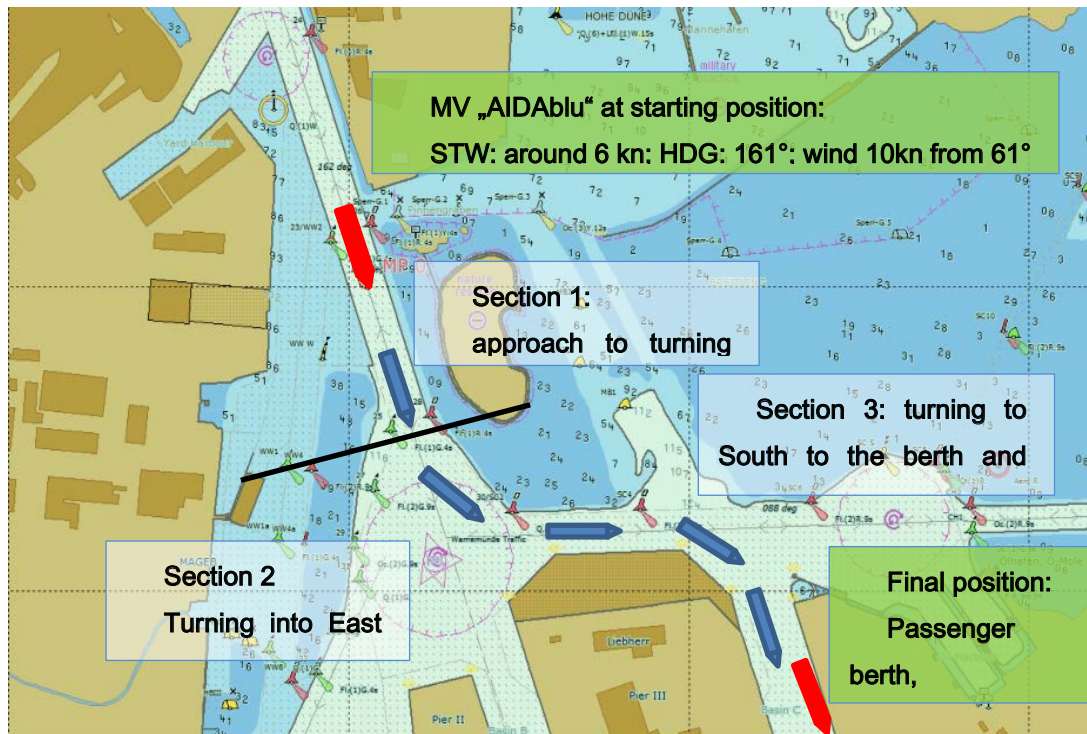

Fig. 3: Exercise area and environmental conditions in Port of Rostock for berthing scenario, divided into two sections for planning the manoeuvres and completed by guessing for desired positions as ship shapes

As shown in the figure, the respective harbour area is divided into manoeuvring sections, which are following a specific aim:

1. Section: ship speed should be reduced until she is ready to be turned, SOG should be around 3 kn to be prepared for section 2.
2. Section: the ship should be turned and adjusted to go in the fairway on East course
3. Section: the ship should be turned into South basin and stopped to be berthed.

In the conventional briefing, only these rough indications of the manoeuvring status can be used to develop a potential strategy for berthing the ship. In conventional berth plans only ship contours are used to be positioned in drawings with WORD or POWER POINT - The specific manoeuvres and settings of engine rudder and thrusters cannot be discussed in detail because specific manoeuvring characteristics can hardly be used for the specific situations. And real time simulation is too time consuming. The fast time simulation allows for new methods for individual exercise preparation with self-developed manoeuvring concepts:

- Using the simulator bridge handles to try out the manoeuvring behaviour for more conditions than in the manoeuvring booklet and also related to the specific geographic area - any potential manoeuvre commands e.g. on the distinguished positions in Fig. 3 and varying the external conditions as “what – if” discussions.
- Drafting Manoeuvring Concept in more detail as Manoeuvring Plan with the Design and Planning tool and optimisation of the concept by several planning trials with that tool,
- Pre-Training with Trial and Training Tool to try out the concept with real time simulation on a laptop

2.2 Ship familiarisation and briefing with Planning Tool and virtual handles as well as Monitoring tool with the bridge handles

By using the FTS for Ship Manoeuvring Familiarisation, the trainee can try out the manoeuvring behaviour for more conditions than in the manoeuvring booklet and also related to the specific geographic area and conditions given for the exercise. Furthermore, any potential manoeuvre commands can be tried out at any distinguished positions like exemplarily given in Fig. 3, even by varying the external conditions as “what – if” discussions.

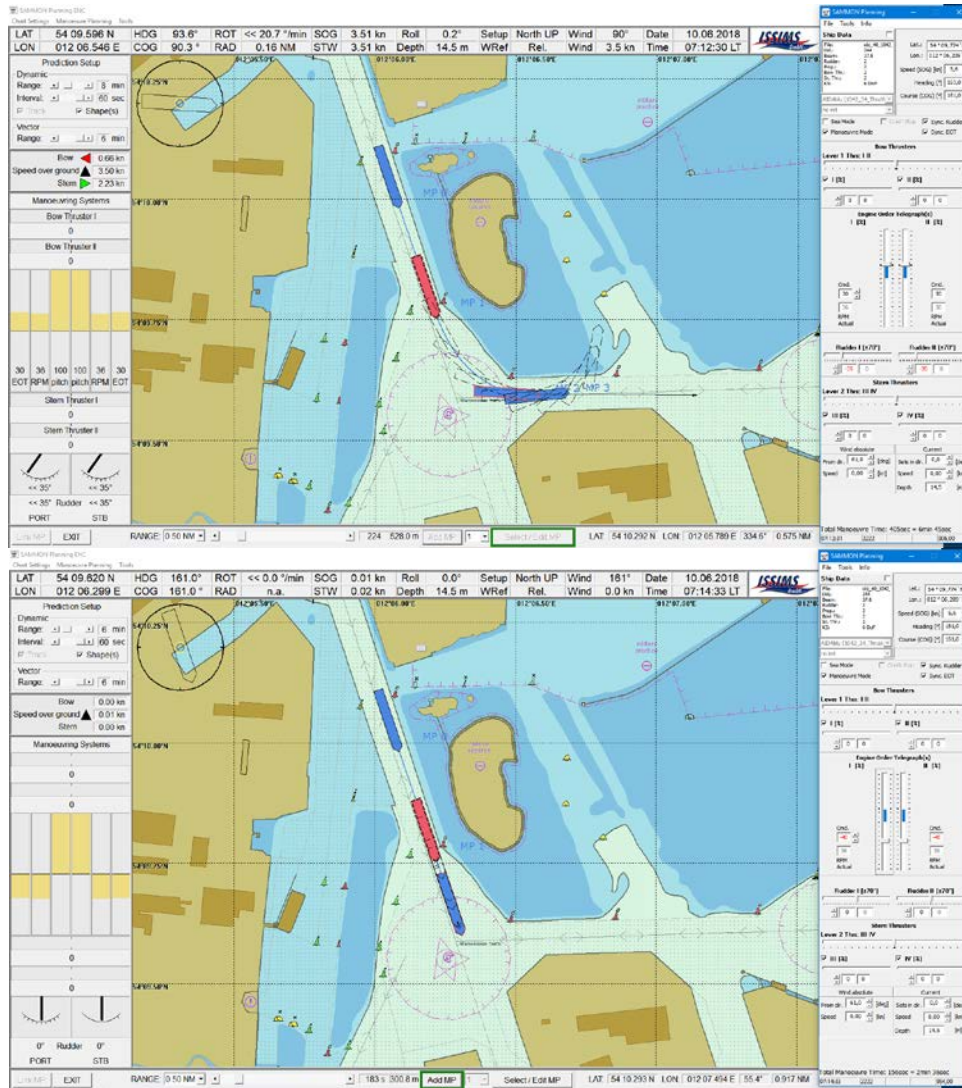

Fig. 4: Ship Familiarisation for turning and stopping characteristics with the Planning tool using the virtual interface on the right side. The Manoeuvring paths are shown in the centred ENC.

For the sample depicted in Fig. 4 the manoeuvre starts at the red shape for EOT 30% at constant speed SOG = 5.6 kn. In the upper part a turning circle with Hard Port -35° is predicted, while in the bottom picture a stopping manoeuvre with Half Astern EOT=-40% is presented.

Both, turning and stopping capabilities are investigated at the position when entering the turning area, this is done using the Planning Tool and virtual interface handle panel. The manoeuvres are started at the given speed in the scenario from Slow Ahead, in contrary to the standard manoeuvres Hard Rudder or Crash Stop in the Manoeuvring booklet which are commonly performed with service speed or Full Ahead speed, or alternatively with the real handles on the simulator bridge using the Monitoring tool.

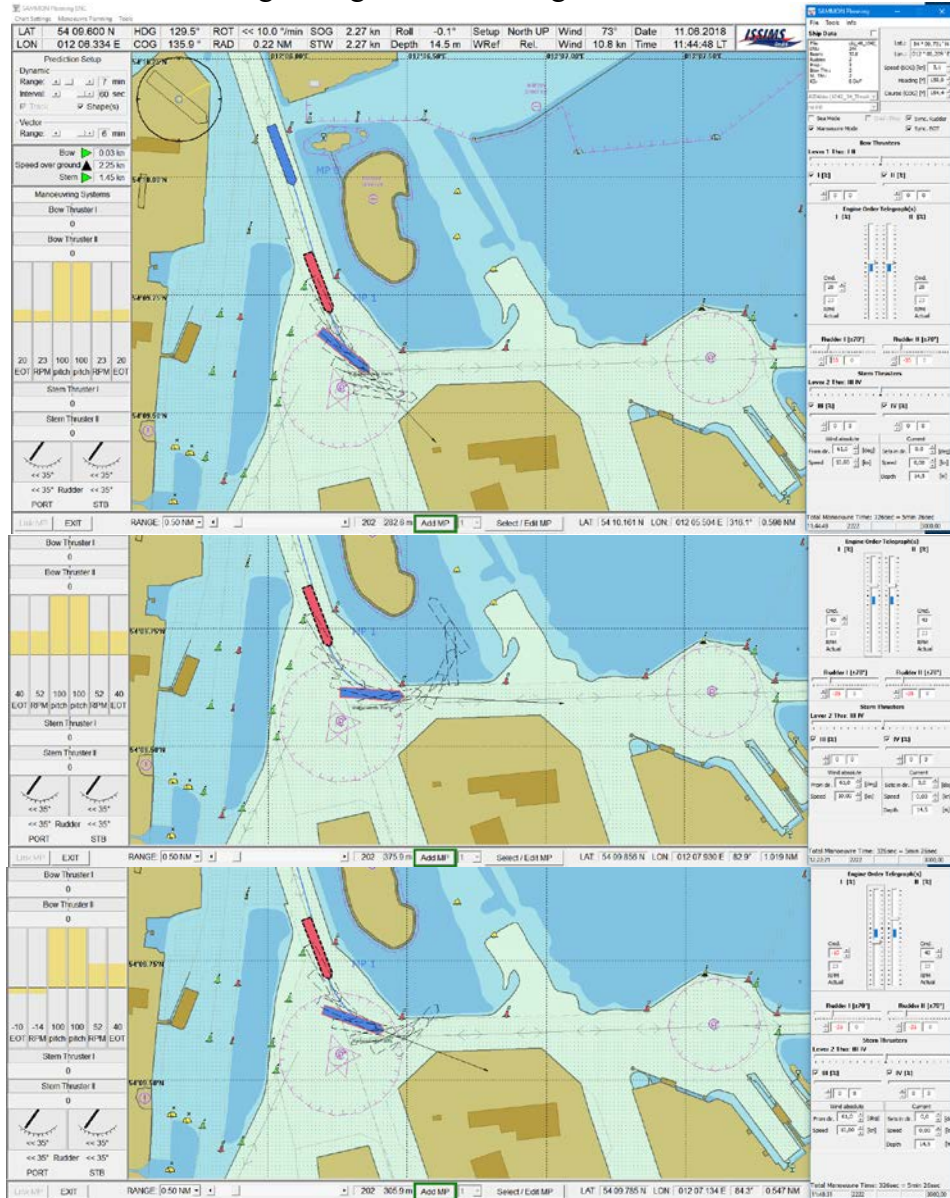

Fig. 5: Use of Planning Tool for Ship Specific Manoeuvring Tasks trying out different options for turning into the East Channel with rudder PT -35° and different engine commands. The manoeuvre starts at the red shape for EOT 20% at constant speed SOG = 3.1 kn (Top: constant engine EOT 20% - the ship is drifting away due to the wind, Middle: With increasing EOT to 40% - this "Kick turn" improves turning, Bottom: with Split Engines PT-10% and SB+40% the ship also increases turning

In Fig. 5 the planning tool is used to investigate Ship Specific Manoeuvring Tasks, e.g. for turning into a channel comparing different options with rudder only, kick turns, split engines and thrusters (to ease swept path).

In Fig. 6 the Monitoring Tool is used to also investigate different options for turning into the East Channel, but this time with the simulator Ship Bridge Handles. This improves the “Touch & Feel” for shiphandling and has some advantages specifically for complex control panels e.g. for azimuth thrusters

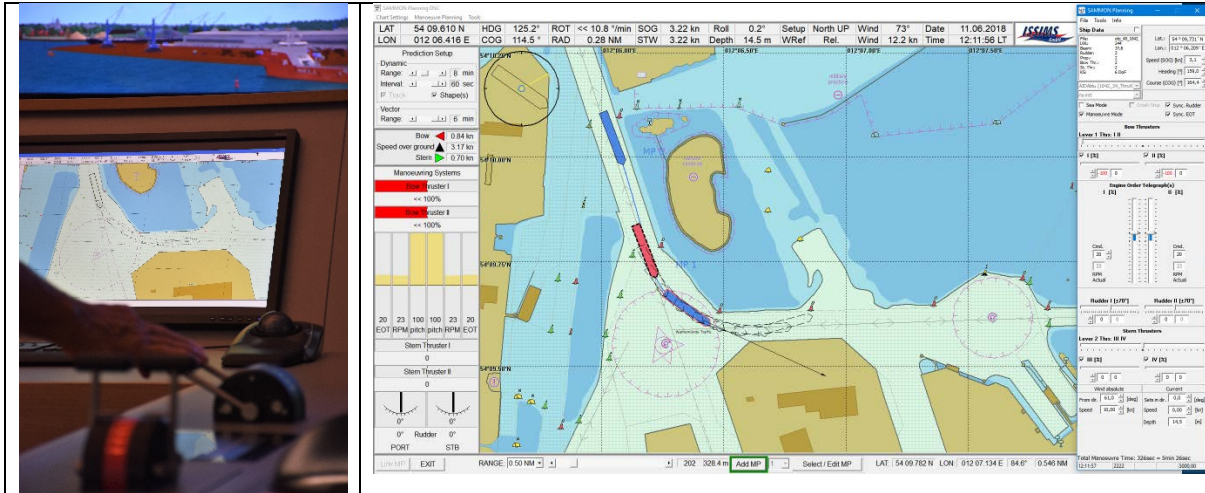

Fig. 6: Use of Monitoring Tool and Simulator Bridge Handles (left) compared to Planning tool (right) for Ship Specific Manoeuvring Tasks trying out options for turning into the East Channel with Bow Thruster. The manoeuvre starts at the red shape for constant EOT 20% at constant speed SOG = 3.1 kn using the Bow Thruster to PT -100% only - the ship is making the turn and has minimum swept path compared to manoeuvres with rudder

2.3 Advanced Briefing with preparation of Full Manoeuvring Concept by means of the “Manoeuvre Planning & Design Module”

With the new fast time Simulation there is the chance for designing a complete Manoeuvre Plan as a detailed strategy with the specific settings at distinguished positions called the Manoeuvring Points MP where the controls can be changed to adjust for the next segment to the next MP. Some basic functions and interface displays for the Fast Time Simulation within the Design and Planning Tool are shown in the next figures. Fig. 7 explains the method in a sea chart environment represented by an interface, which combines

- the electronic navigational chart ENC window (centre),
- the interface window for the steering panel of the ship (right) for adjusting the controls for the selected manoeuvring point MP and the
- the interface to display the status of the current actual ship manoeuvring controls (left) at the position of the next manoeuvring point MP which is indicated as ship shape in red colour in the ENC.

In the following, the course of actions is described in a series of figures to make a full

manoeuvring plan by means of the control actions at the manoeuvring points MP – this will be done for easy conditions with 10 kn wind from 61° and no current to explain the procedure of fast time planning: In Fig. 7 the initial position MP 0 is to be seen where the ship was set in the centre of the fairway. The first task for the trainee is to find the balance condition under wind in the fairway: after some easy attempts, a drift angle of about 2° and rudder angle -1° was adjusted as average value to stay in the fairway.

The ship has already been moved by the slider at the ENC bottom to set the next manoeuvring point MP 1: there the turning manoeuvre is started with EOT -30%. The prediction already shows that the ship would lose speed according to the handle positions.



Fig. 7: Fast time planning in sea chart on a big touch screen or on a laptop: Initial ship position (red shape) at MP0 is set with adjusted heading and rudder angles to balance the wind 10kn from 61°. The prediction (black dotted shapes) shows the motion of the ship due to the handle setting on the right window. The ship is moved as blue shape by the time slider at the bottom from MP0 to the next position to be set as following MP1

In Fig. 8 a manoeuvring point MP1 is set and the controls are adjusted to steer into the East channel using rudder and in parallel thruster to ease the swept path.

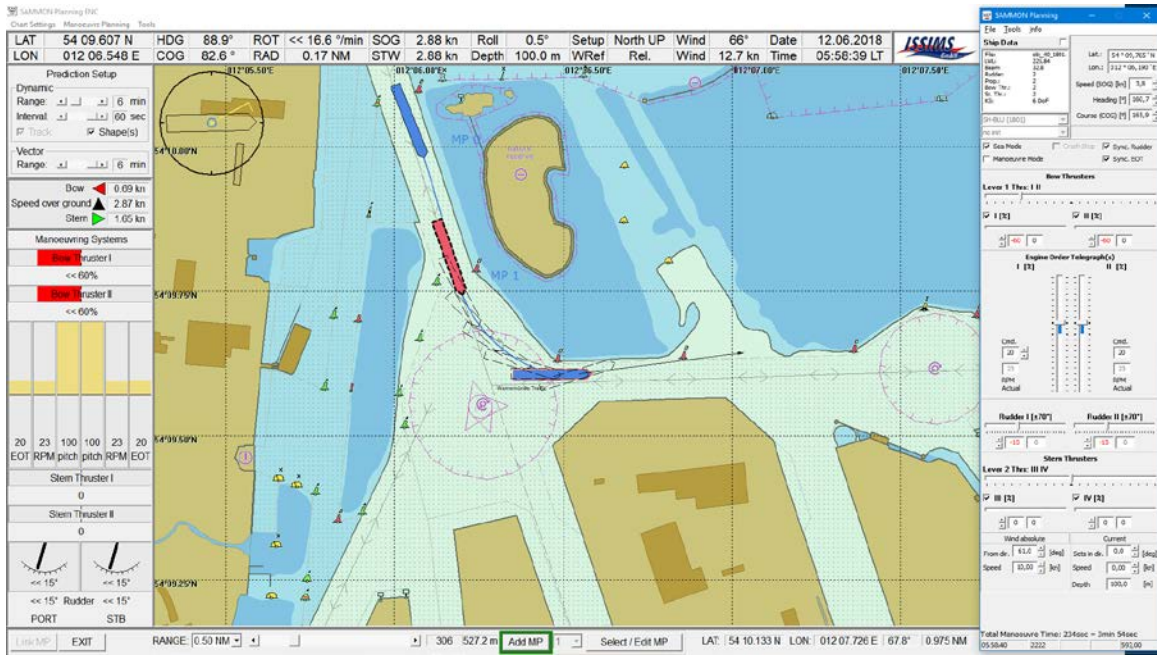

Fig. 8: Ship position at MP2 and prediction for the turning manoeuvre: The prediction shows that the ship is turning properly with small swept path due to the set handle positions of Bow Thruster with PT -60% and rudder PT -15°

The full potential of the fast time simulation can be seen for challenging weather conditions: In Fig. 9 in intermediate scenario is investigated for the case if a wind gust of 30 kn is suddenly blowing from 61°. With the same settings as in the previous example the ship would drift away but with an alternative strategy with split engines and stronger rudder the ship can be turned into the channel – and there are even reserves with thruster and others.

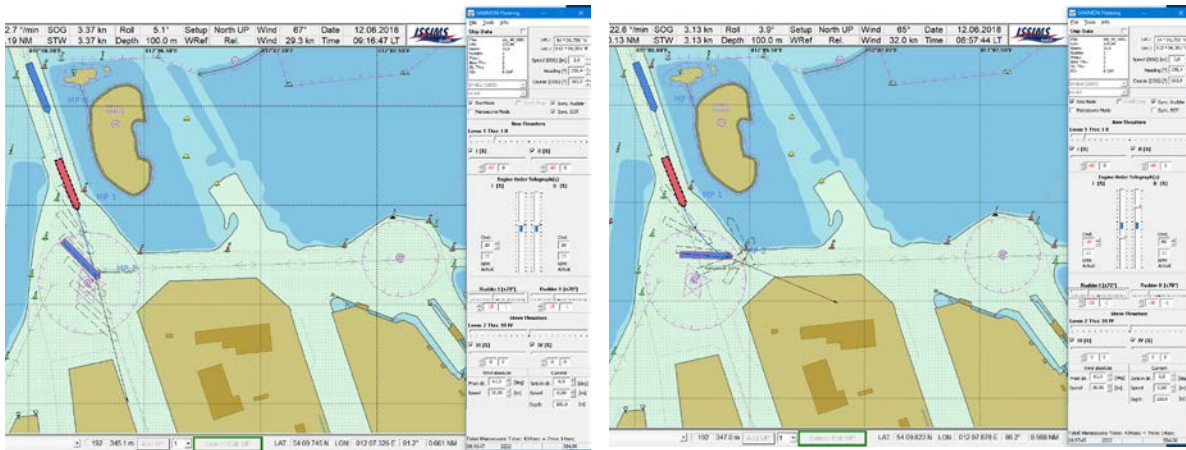

Fig. 9: What happens if at Ship position MP1 a wind gust with 30kn will start? - demonstration of consequences with no extra action and with alternative strategy:

- Left: With the original settings the ship drifts away Fig. 8),
- Right: more powerful solution with split engines (PT -20%, SB +60%) and more thruster -80% and stronger rudder support PT -30°

In Fig. 10 the regular planning for the manoeuvring plan continues with the next segment to stop the turning and proceed in the straight channel. In Fig. 11 the ship enters the South basin.

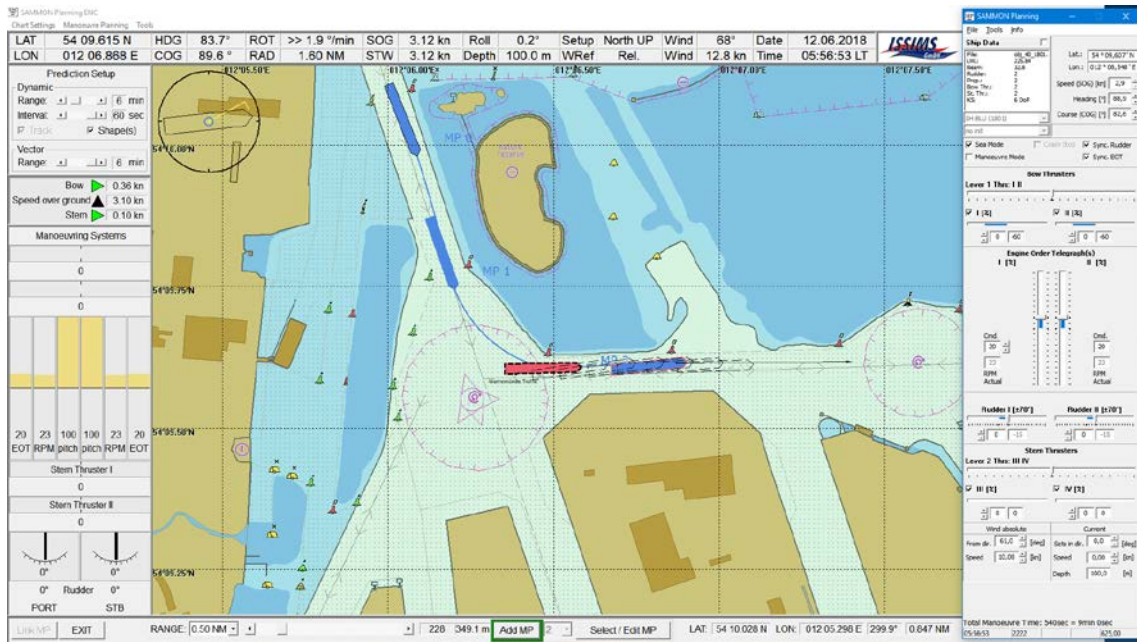

Fig. 10: Stop turning at MP 2 and steady at the straight channel segment – move for the next position to start the turning into the South basin at MP 3

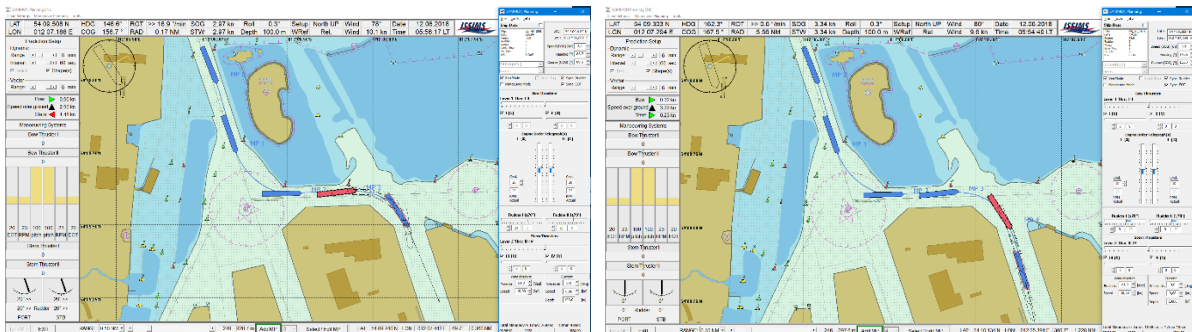

Fig. 11: Continuing the manoeuvring plan: Left: start the turning into the South basin at MP 3
Right: Stop turning and steady parallel to the berth, prepare for stopping at MP 4

In Fig. 12 the complete manoeuvring plan is shown with final stopping manoeuvre and using the thrusters to move the ship to the berth against the wind.

At MP 5 the engines are reversed to reduce speed and to stop the ships at a position parallel to the berth. With the following actions from the next MP 6 the ship is brought close to the berth to be shifted by thrusters to the pier. Afterwards the plan needs a further MP 7 and 8 in

order to reduce the transversal speed shortly before berthing.

For every manoeuvring point text boxes can be opened where information is displayed about the control setting and extra text can be entered for the briefing sessions. The whole manoeuvring plan can be saved and reloaded to be changed in the Edit Mode at every MP to investigate alternative concepts or what – if discussions.

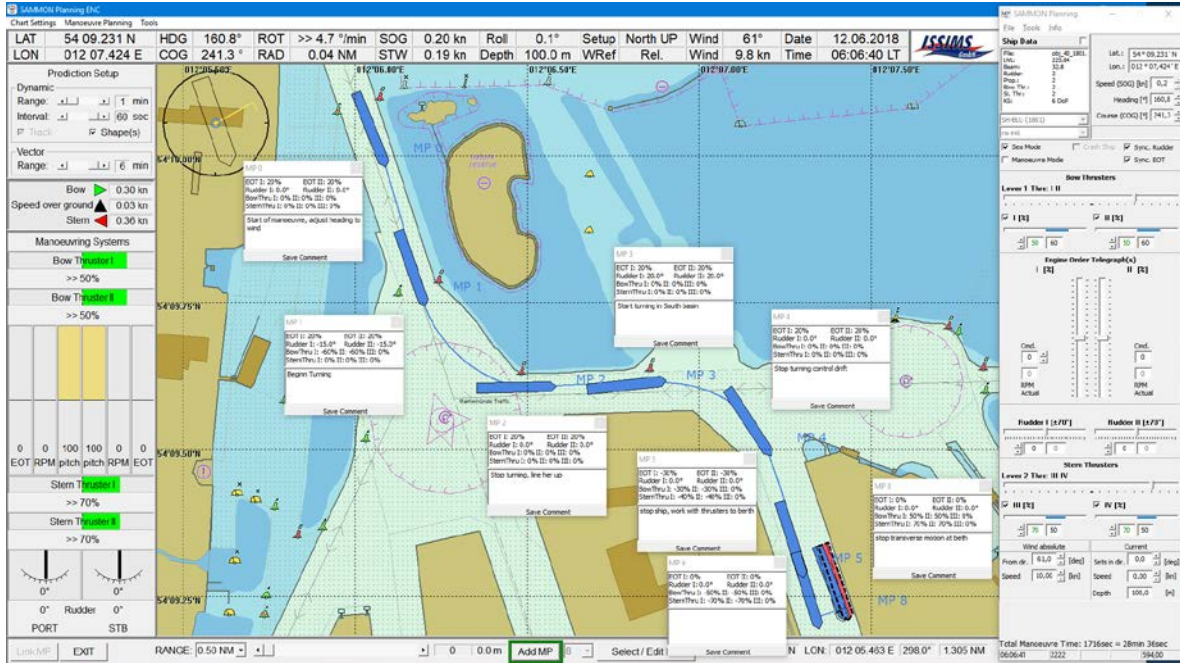

Fig. 12: Complete manoeuvring plan with final stopping manoeuvre and berthing by thrusters; additional manoeuvring point information text boxes show the control setting for the briefing session

1.3 Briefing by means of the „Manoeuvre Trial & Training Module“ on a laptop or on the simulator bridge

The Trail & Training Tool is a desktop simulation tool for real time manoeuvring simulation, Fig. 13. It contains conning information together with the prediction and it can display the planned manoeuvring track. The centre window shows the ENC together with motion parameter for longitudinal and transverse speed. The ships position is displayed as ship contour where also the track prediction can be indicated as curved track or chain of contours for the selected prediction time. The prediction parameters as range or interval of presentation can be set in the control window at the left side.

In Fig. 13 the planned scenario is shown, the ship is just entering the turning area and starts to turn at MP 2. The prepared manoeuvring plan is shown underneath in blue coloured shapes; the manoeuvre control settings from the planning can be displayed in a table on top of the ENC. An alternative briefing is possible using the simulator bride of ANS 6000 together with the SAMMON Monitoring tool. In this case all the handle signals are immediately transferred to the FTS Kernel to predict the manoeuvre and to display the result immediately in Fig. 14.

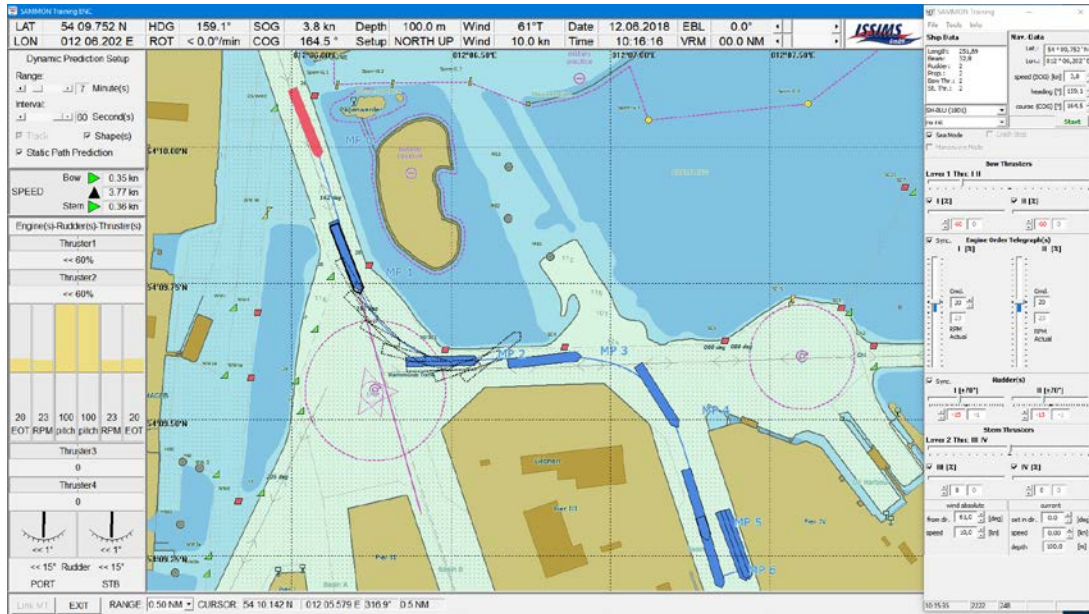

Fig. 13: SAMMON Trail & Training Tool: Real time simulation and Manoeuvring Prediction integrated into ECDIS with comparison of full dynamic predictions (dotted ship contours) and the simple static prediction (magenta curve) together with planned manoeuvring track (blue line) in (same in Monitoring Tool, except the handle panel))

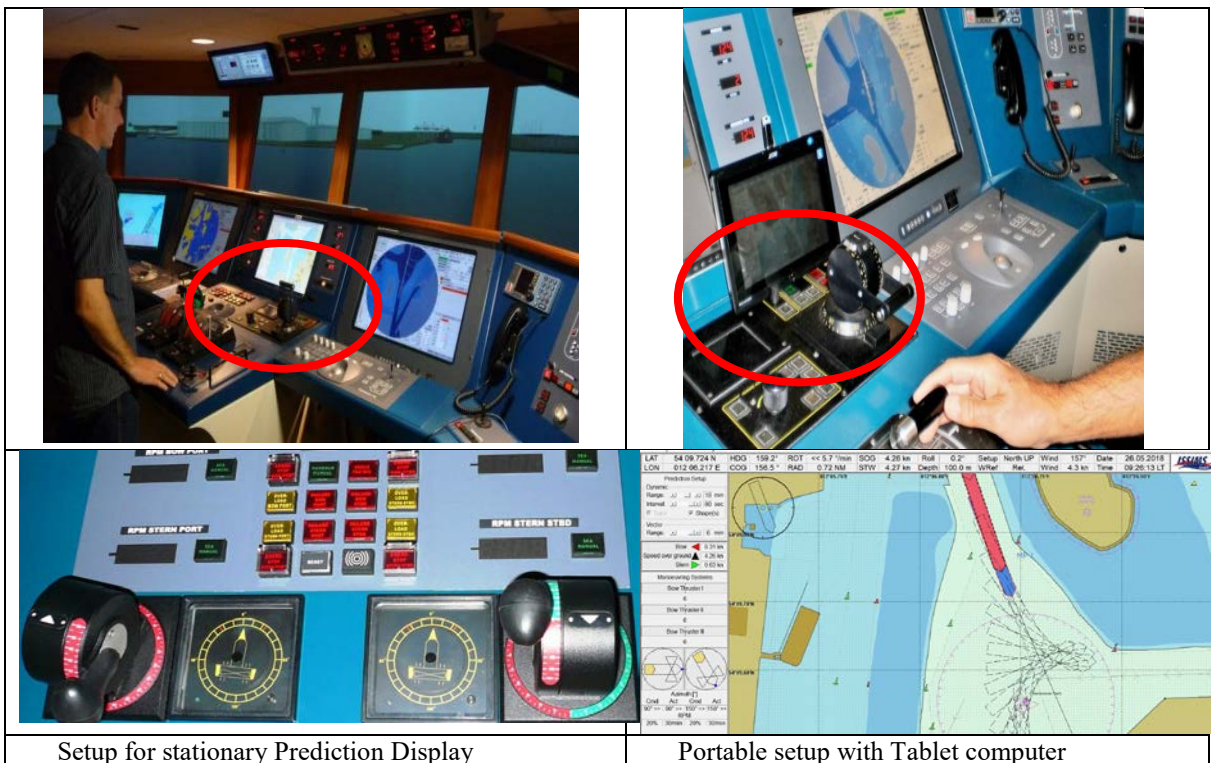

Fig. 14: Briefing by means of the „Monitoring & Conning Module“ using the simulator bridge handles of Bridge 1 in RME ANS 6000 Ship Handling Simulator of MSCW

In this figure on the left side there is shown a setup for stationary Prediction Display on ECDIS of Bridge 1 in RME ANS 6000 Ship Handling Simulator of MSCW – presenting immediate response to commanded position/ settings of handles during the manoeuvring process with Twin Screw Handle Panel (top) and POD Drive Handles (bottom). On the right side there is a portable setup with tablet computer which has been used for students' individual briefing/planning and afterwards for monitoring during execution on the bridge and debriefing (top) and sample of manoeuvring display when presenting a POD ship manoeuvre (bottom).

3. EXECUTION OF EXERCISE AND DEBRIEFING WITH FAST TIME SIMULATION

3.1 Use of Simulation augmented support with SAMMON monitoring Tool in Ship Handling simulator

There are several ways to support the execution and debriefing by the FTS. The support during Execution of Exercise is depending on the degree on what the trainee is allowed to use the new manoeuvring prediction technology during the exercise run.

- On a low level the multiple dynamic prediction may be used to gradually let the student know on his potential options for using the controls as a means for good visualisation of quality of manoeuvres – this is only to support the learning process specifically as long as the new technology is not available on the conventional ships
- On the highest level the trainees can make full use of the dynamic prediction and the prepared manoeuvring plan as underlying concept to achieve the best fit with the plan and the exercise result. The full use of the prediction is increasing safety & effectiveness even for advanced trainees
- For instructors (and peer students) multiple dynamic predictions are always a great help because the chances for success of a trainee's action can immediately be seen or the exercise could be stopped earlier if it is obvious that the trainee will fail.

During debriefing the fast time tools allow for an in-depth assessment of quality of manoeuvring results:

- Assessment of results by comparison with trainees own concept or optimised plan can be shown in the replay function of the Monitoring Tool which can be used with Multiple Prediction functionality; or more in detail within the SIMDAT tool where the time history of the trainees' action can be shown graphically e.g. for rudder, thruster and engine activities
- Discussion of alternative manoeuvres at specific selected situations can be supported by the Design & Planning tool by loading any specific situation during the exercise run and to operate the manoeuvring handles differently.

During the exercise, it is possible to take advantage from the Multiple Prediction for the manoeuvres. In Fig. 15: the setup is to be seen where the instructor or bring their laptop onto the simulator bridge (where the manoeuvring plan might have been developed), the prediction is controlled via the bridge handles. The same laptop with the Monitoring tool can also be placed at the instructor station.



Fig. 15: Using Multiple Prediction in Simulator Training at MSTC of AIDA Cruises Rostock. Left: Portable Setup for Prediction Display in Monitoring Tool on Trainees Laptop on Bridge - the prediction is controlled by the Bridge Handle via WLAN. Right: Prediction Display in Debriefing session (left screen): The dynamic prediction can be used even during Fast Replay to complement the simulator instructor display (right screen)

The benefit of using the FTS is to be seen for several purposes:

- The multiple dynamic predictions shown on the instructor's screen are always a great help for instructors and maybe also for peer students looking over their shoulders to learn from the actions of the other trainees in charge on the bridge. They have a better overview on the current situation and the chances for the potential success of a trainee's action can immediately be seen; the exercise could be stopped earlier if it is obvious that the trainee will fail.
- Multiple dynamic prediction may be used to gradually let the student know on his potential options for using the controls as a means for good visualisation of the quality of manoeuvres – this is to support the learning process specifically as long as the new technology is not available on the conventional ships.
- If the trainees are allowed to make full use of the dynamic prediction and also the prepared manoeuvring plan as underlying concept they achieve the best fit with the plan and the exercise result. The full use of the prediction is increasing safety & effectiveness even for advanced trainees and can support to find out the best performance.

3.2 Debriefing of Exercise and Comparison of results with Manoeuvring plan

Several methods of comparison exist for the debriefing after the training by using FTS software. Whilst in the Ship Handling Simulator (SHS) there is the possibility to additionally record the training session using the „Monitoring & Manoeuvring Module“, there's a correspondent option to save the training and planning procedure in the „Trial & Training“ as well as in the „Manoeuvre Design & Planning Modules“. All of the files from the planning and from the execution can be shown together in form of the ship track as well as in diagrams from several parameters over the whole manoeuvring time in the SIMDAT program. The following figures show some possible methods to display the results.

Fig. 15 compares simulator results of the trainees with different level of preparation. The achievements of the better prepared trainee are obvious – the planned manoeuvre is very close to the executed track and the actions of the controls were nearly in accordance with the planned procedures. There is not just a reduction of manoeuvring time when applying the Fast Time

Simulation tool in briefing and training; the thruster diagrams show also that a well-prepared manoeuvre can minimize the use of propulsion units and therefore be more efficient. The great advantage of the Fast Time Simulation is the opportunity to discuss alternatives of manoeuvres and also effects and strategies for different environmental conditions, which might affect the ship unexpectedly at critical positions.

Additionally, the results of an exercise can be stored as simulator recordings and replayed afterwards in real time or fast mode on the bridge as “Live Replay” including the visual systems and bridges handle settings or alternatively in screens in the debriefing room. In parallel to the replay the Monitoring Tool can be used to display the manoeuvring process together with the multiple manoeuvring predictions and the manoeuvring plan as reference to the concept of the trainee - This is like looking through a spyglass to give a wider perspective on the actions of the trainees.

4. CONCLUSIONS / OUTLOOK

Fast Time Manoeuvring simulation has proven its benefits for both lecturing and training for improving ship handling knowledge and skills. It can be used as an individual training tool but unfolds its potential interfaced to a full mission simulator which is successfully implemented with the Rheinmetall Electronics ANS 6000 Ship Handling Simulator, manufactured and distributed by MarineSoft / benntec. It increases the effectiveness of simulation training but also the success rate of the trainees is increasing: An analysis has shown that even less experienced navigators are able to successfully manage demanding ship handling exercises after preparation & briefing using the SAMMON planning tool on the same quality level and with a smaller failure rate as experienced professionals [8].

For the future, the use of the simulation modules for other purposes of ship operation will be investigated. This includes the involvement into real ship operation on-board [10]. The majority of the participants in the ship handling courses expressed their opinion that the Design & Planning Module could be used for preparing berth plan on the ships. There is a high potential for optimisation to reduce manoeuvring time and fuel consumptions /emissions [11]. It is also possible to use the potential of FTS for various analyses (e.g. fairway layout, accidents) to find measures to make shipping safer.

ACKNOWLEDGEMENTS

The presented results were partly achieved in research projects “Multi Media for Improvement of MET” - MultiSimMan and MultiSimMan-GREEN, funded by the German Federal Ministry of Education and Research (BMBF) surveyed by DLR-Project Management Agency. The professional version of the SAMMON software tools has been further developed by the start-up company Innovative Ship Simulation and Maritime Systems GmbH (ISSIMS GmbH) [9].

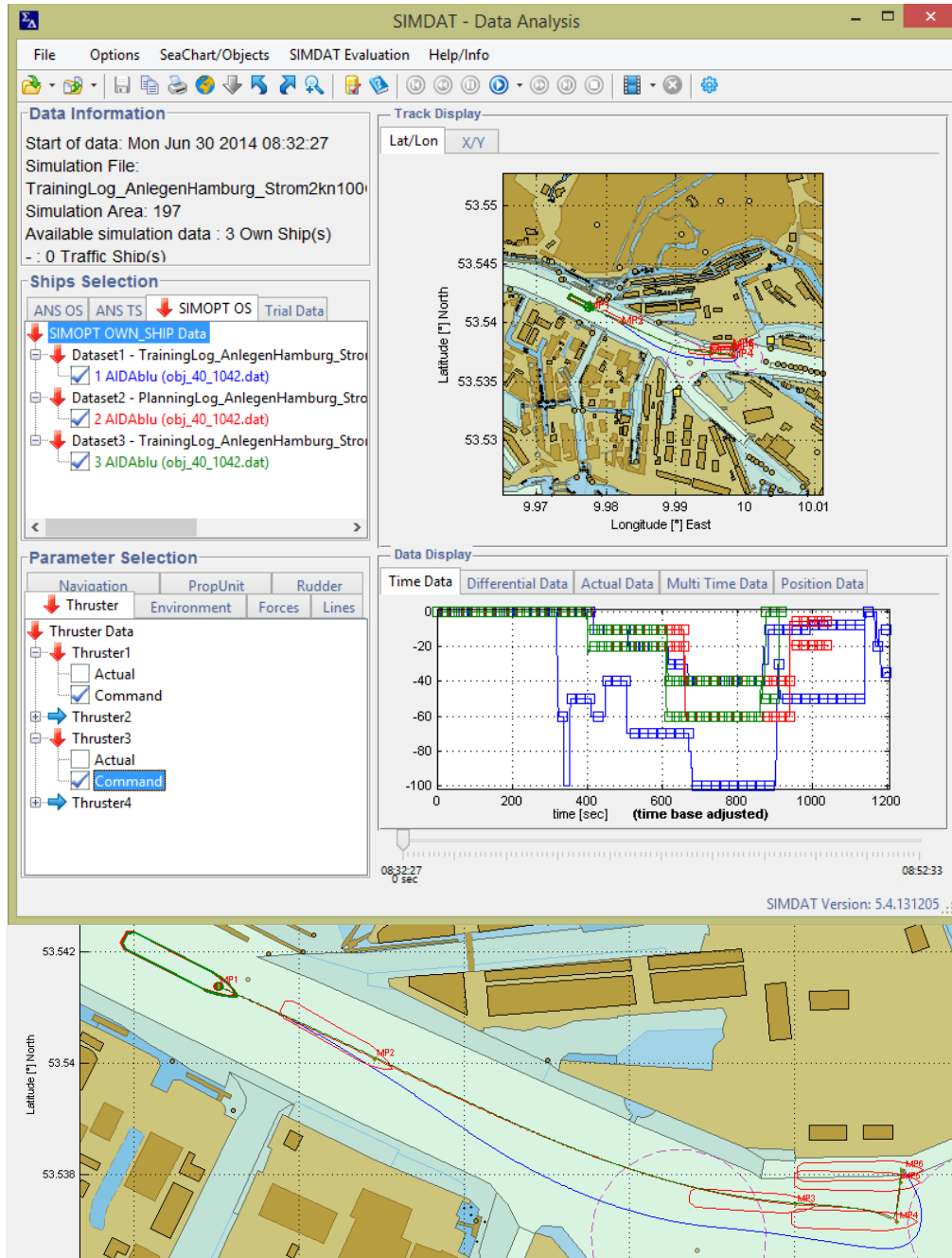

Fig. 16: Results from two manoeuvring exercises in Port of Hamburg with Cruise ship in SIMDAT interface (Top: "Track Display" with contours; Blow: „Data Display“ for time history for thruster activities, Bottom: extract of sea chart from Track Display) and comparison to the prepared manoeuvring plan (below). Blue: run of the trainee without support by Fast Time Simulation; Green: run of the trainee with full support by pre-planning with Design and Planning Module; Red: prepared manoeuvring plan with manoeuvring points MP

REFERENCES

- [1] BENEDICT, K. (2016), Control your pivot point position in ship handling - Multimedia approach by Fast Time Simulation, IMSF 2016 AGM Seminar, Ilawa
- [2] BENEDICT, K.; BALDAUF, M.; FELSENSTEIN, C.; KIRCHHOFF, M. (2006), Computer-based support for the evaluation of ship handling simulator exercise results. *WMU Journal Maritime Affairs* (2006) 5: 17. <https://doi.org/10.1007/BF03195079>
- [3] BENEDICT, K.; BALDAUF, M.; FISCHER, S.; GLUCH, M.; KIRCHHOFF, M.; SCHAUB, M.; KLAES, S. (2012), Fast time manoeuvring simulation as decision support for planning and monitoring of ship handling processes for ship operation on-board and training in simulators. *Proceedings Int. Conf. Marine Simulation and Ship Manoeuvrability (MARSIM)*, Singapore
- [4] BENEDICT, K.; BALDAUF, M.; FISCHER, S.; GLUCH, M.; KIRCHHOFF, M.; SCHAUB, M.; KRÜGER, C-P.; KLAES, S. (2016), *Simulation technology brings new visualisation of the future ships path – and advanced use of the well-known speed vector*, 24th Int. Maritime Lecturers Association Conf. “Quality Standards in Maritime Education”, Galveston USA
- [5] BENEDICT, K.; BALDAUF, M.; KIRCHHOFF, M.; KOEPNICK, W.; EYRICH R. (2006), Combining fast-time simulation and automatic assessment for tuning of simulator ship models. *Proceedings Int. Conf. Marine Simulation and Ship Manoeuvrability (MARSIM)*, Terschelling
- [6] KRÜGER, C-M.; SCHAUB, M.; BENEDICT, K.; KIRCHHOFF, M.; GLUCH, M.; FISCHER, S. (2015): Simulation-augmented manoeuvring support for ship handling on board and from shore. *Proceedings 14th Int. Conf. Computer and IT Applications in the Maritime Industries (COMPIT)*, Ulrichshusen, /Germany pp.74-88
- [7] SCHAUB, M.; BENEDICT, K.; GLUCH, M.; MILBRADT, G.; TUSCHLING, G.; KIRCHHOFF, M. (2015): Modelling of ships for simulator-training and simulation-augmented manoeuvring support on board and from the shore. *Proceedings Int. Conf. Marine Simulation and Ship Manoeuvrability (MARSIM)*, Newcastle
- [8] GÜNEKBAY, B: APPLICATION OF FAST TIME SIMULATION FOR TRAINING COURSES OF SHIP OFFICERS. *Master Thesis at Dept. of Maritime Studies Rostock Warnemuende, Hochschule Wismar, University of Applied Sciences - Technology, Business and Design*. Rostock / Germany May 2015
- [9] Website Innovative Ship Simulation and Maritime Systems GmbH (ISSIMS GmbH; www.is-sims-gmbh.com).
- [10] Baldauf M, Mehdi R., Schaub M, Benedict K, Milbradt G; Finger G, Fischer S (2018): Simulation-based Support to Minimize Emissions and Improve Energy Efficiency of Ship Operations. *In: Ölcer A et al (eds) Trends and Challenges in Maritime Energy Management*. Springer International Publishing. DOI 10.1007/978-3-319-74576-3
- [11] Baldauf M, Benedict K, Kirchhoff, M, Schaub M, Gluch M, Fischer S (2018): Energy-efficient Ship Operation - The Concept of Green Manoeuvring. *In: Froholdt LL (ed.) Corporate Social Responsibility in the Maritime Industry*. Springer International Publishing. DOI 10.1007/978-3-319-69143-5_11 pp. 185-218
- [12] Baldauf, M.; Benedict, K. (2018) Innovative Fast Time Simulation for Training. *SEAWAYS – The International Journal of the Nautical Institute*, March 2018, , pp. 6-11

FACTORS THAT AFFECT THE DELAYED EMBARKATION FOR AND RETURN FROM SHIPBOARD TRAINING OF MAAP CADETS

DOMINIQUE ANDREW M. PEDREGOSA^{*}, SHAMIR B. AKMAD[†] AND BRUCE
DAVID S. SODOLSKI[†]

^{*} Academic Research Unit
Maritime Academy of Asia and the Pacific
Kamaya Point, Brgy. Alas-asin, Mariveles, Bataan, Philippines
e-mail: pedz0865@gmail.com, <https://maap.edu.ph>

[†] College of Maritime Transportation
Maritime Academy of Asia and the Pacific
Kamaya Point, Brgy. Alas-asin, Mariveles, Bataan, Philippines
e-mail: pedz0865@gmail.com, <https://maap.edu.ph>

Keywords: Shipboard Training, Delay, Factors, MAAP

Abstract. *The general aim of the study was to identify the factors that affected the delayed embarkation for and return from Shipboard Training of cadets from the Maritime Academy of Asia and the Pacific (MAAP). In this paper, the researchers set three different phases of Shipboard Training, namely: 1. Pre-Shipboard Training, 2. Shipboard Training, and 3. Post-Shipboard Training, to categorize the factors of delay and to determine the extent of delay which these factors generated. The research involved fourth-year cadets who came back from a one-year Shipboard Training, set during their third year of study. Using a validated survey form and by implementing one-on-one interview with every respondent, the researchers were able to collect data needed for the completion of this paper. Of all the factors in the first and second phases, Shipboard Training Contract and Vessel Assignment appeared to be the most dominant factors that caused the delay of MAAP cadets. The said factors of the delay were most evident during the Pre-Shipboard Training phase. From the 80 respondents, the majority of respondents (48 of 80) were affected during the Pre-Shipboard Training phase by either In-House Trainings, Vessel Assignment, Company Requirements or any combination of these three. During the Shipboard Training phase, the majority of the respondents (54 of 80) were affected by Contract and Vessel Assignment. For the Post-Shipboard Training phase, 37 out of 80 were delayed due to Enrollment. The Pre-Shipboard Training phase proved to affect cadets the most in terms of the duration of the delay. It had a median value of four months, as compared to the median value of one month for both Shipboard Training and Post-Shipboard Training phases. With these results, the researchers recommended that Shipping Companies, Manning Agencies, and the Academy should organize studies to improve the forecasting of Cadet demand vis-à-vis vessel availability. Furthermore, close coordination with the Academy's Department of Shipboard Training and Shipping Companies / Manning Agencies should include projecting Cadet's training schedule, embarkation, vessel transfer,*

disembarkation, and overall Shipboard Training duration. As part of the Pre-Shipboard Orientation, the Academy should cascade the results of this research to the MAAP cadets who are going on Shipboard Training so that they are made aware of the existence and extent of these factors that cause delay.

1 INTRODUCTION

In 2009, MAAP started implementing two graduations in an academic year as the Institution began to accommodate twice the number of enrollees to cope with the demands of the Stakeholders. Also, as a way of accommodating varying Stakeholders demands, MAAP implemented two academic schemes, namely the 2-1-1 and 3-1 schemes. These schemes were guided by the Commission on Higher Education's proposed Programs of Study outlined in CHED CMO No.67 and No.70. In these memoranda, a BSMT or BSMarE student should have a total of three years' academics and one year of shipboard training.

To be able to graduate, a cadet must comply with all academic requirement set by the Academy and must complete one year of shipboard training. Failure to comply with the requirements would merit a deferment to the next graduation date, whether within the same academic year or the next.

Over the years, there has been considerable growth in the number of cadets who fail to graduate within their respective graduation year. The disparity between the number of graduates during the first and second graduation within the same year was becoming a concern as the second batch were more often more populous than the first batch.

Results of cadet exit interviews conducted by the Academy revealed that the cadets deem Shipboard training as the major cause of failing to graduate on time. Specifically, the cadets noted that Shipboard Training accounts for the considerable delay of returning to the Academy, either for graduation (3-1 scheme) or resuming academic study (2-1-1 scheme).

1.1 Conceptual framework

The conceptual framework simplifies how the various factors contribute to the ultimate concern of the researchers: being delayed in embarkation for, and return from, Shipboard Training of MAAP cadets. The researchers initially identify the various independent variables that cause the delay to be: Medical Causes, Behavioral Factors, Completion of Documents, Vessel Assignment, Company Policies, and Training Requirements, which are present among the three phases we have categorized into Pre-Shipboard-Training, Shipboard-Training, and Post-Shipboard-Training.

1.2 Statement of the problem

The general objective of the study is to determine the factors that cause the delay of embarkation for and return from, Shipboard Training of cadets to potentially discover vital areas from which plausible recommendations can be drawn to avoid such delays in the future. Specifically, the study sought to answer the following questions 1.) What are the factors that affect the delay of embarkation of MAAP cadets? 2.) What are the factors that affect the delay of return from Shipboard Training of MAAP cadets? and 3.) Which of the three phases, Pre-Shipboard-Training, Shipboard-Training, and Post-Shipboard-Training have the most dominant effect in the delay of MAAP cadets?

1.3 Hypothesis of the study

1. Vessel Assignment has a dominant effect on the delay of embarkation of MAAP cadets for Shipboard Training.
2. Contract and Vessel Assignment has the most significant impact on the delay of midshipmen during Shipboard Training, while Enrollment has the greatest effect on the cadets' delay on the Post-Shipboard-Training period.
3. Among the three phases, Pre-Shipboard Training is the most critical period in terms of contributing most to cadets' delays.

1.4 Significance of the study

The findings of the study are deemed significant to the following entities:

cadets of MAAP. The researchers believe that this paper would help the cadets in making necessary solutions should these cadets ever encounter any of the factors affecting the delay of their embarkation for Shipboard Training.

Institution. The institution would have a grasp of not only the magnitude of this occurrence but also the reason why this occurs in the first place. In its capacity, the Academy can set in place preventive measures to address this situation and mitigate the effect of this problem.

Stakeholders. It cannot be stressed enough that the Stakeholders play a crucial role in addressing this concern. From the time the Institutions sends the cadet to their offices for shipboard training to the time that the cadet returns to the Academy, it is the Stakeholders who have control over the cadets. In the business side of things, cadets are investments made by Stakeholders to secure their long-term financial standing. The sooner the cadets graduate, the sooner they become part of the pool of officers at the company's disposal. The sooner they can get to work; the sooner the return of investment would be for the company.

1.5 Scope and delimitation

The study involves fourth-year cadets (with the 2-1-1 scheme) of the Maritime Academy of Asia and the Pacific, currently enrolled for the Academic Year 2017-2018, who completed 12 months of Shipboard Training for BSMT and or BSMarE (as required by STCW).

1.6 Literature review

Singh (2017) recognizes in his article five problems that the shipping industry is currently facing that needs to be resolved immediately. Along with other problems, the author also identifies the difficulty to join a ship as one. The author states that for seafarers, it has become more challenging to travel and join a ship at a faraway port, contending that ships are loaded and all set to sail by the time the visa is accomplished. The problem of lenient registries in other countries such as Belize and the Marshall Islands make countries such as the Philippines and Ukraine take things more seriously by improving the quality of the training these countries offer. Document requirements and completion may also be a vital issue in this discussion. According to the author, fast loading and discharging rates contribute to the difficulty in joining a ship such that before the necessary documents, such as the visa can be processed, the vessel would already be done with loading and about to set sail.

A significant feature of the Shipboard Training for cadets is described in the study of

Livingstone, Caesar (2013). He describes the cadet training system as being designed to principally ensure that there is a consistent pool of skilled cadets from which the different companies could select their next officers. Shipboard Training, being penultimate to officership, is already part of the practice of maritime employment. A continuously growing international fleet, which foreshadows the lack of merchant marine officers, calls for a re-evaluation of maritime policies in the labor market of the maritime industry (WMU Journal of Maritime Affairs, 2015). Maritime policies and national policies, being the foundations of maritime employment and the deployment grounds for Shipboard Training, dramatically affects the variables of interest for the researchers. These factors may be less perceivable to the cadets, however, with the companies and the national authority having the firsthand information on such variables. Some are more evident however to the cadets, such as restrictions on nationality when it comes to employment, or preferences at the very least, whether positively or negatively. If the competitiveness of our country is severed because of these circumstances, we can, in turn, expect difficulties to arise, even if we only take the stance of those waiting for their Shipboard Training.

There exists definite dynamics in the labor market of the maritime industry, among these, are vacancies and movements in employment and the workforce, as well as changes in the activity content, according to Kalvaitiene and Sencila (2013). Considering this situation of the maritime sector drives the need for professional career planning among future seafarers and the corresponding skills development thereof. It then becomes the burden of Maritime Education and Training Institutions to both ensure their primary function of preparing qualified individuals and to ensure a systematic and streamlined education for the profession. In their study, it has been revealed that cadets do not usually regard matters such as professional career planning. The study showed that success in a student's professional career is patterned by three components: professional competence, general and career planning skills. With Shipboard Training as a pathway to a professional career, the researchers view the importance of professional career planning skills as an important quality for a cadet to possess. Certain career planning skills and their decision-making capabilities greatly affect their Shipboard Training and the time spent in such activities up to their graduation.

Dizon and Vergara (2013) discusses on the same issue of delays in shipboard training and reveals the requirements, certificates, and documents takes cadets several weeks or even months to accomplish. Vessel availability was also cited as one of these factors, and the study even stated on age limit being imposed and serving as a barrier to early employment. The study even went as deep as to answer how these delays can even affect the educational and training process of these cadets.

2 METHODOLOGY

2.1 Research design

The research is a descriptive-correlational study wherein the independent variables have a relationship with the dependent variables. Through qualitative analysis, the researchers gained an understanding through underlying reasons, opinions, and insights through formal and informal interviews used to develop appropriate ideas and or hypotheses to solve the existing problem. Furthermore, the researchers incorporated the design of quantitative research as there would be numerical analyses and statistical treatment of data (which were gathered

through questionnaires) for this particular paper.

2.2 Population of the study

The study involves one hundred (100) fourth-year cadets (2-1-1 scheme) of the Maritime Academy of Asia and the Pacific, enrolled for the Academic Year 2017-2018, who completed Shipboard Training requirement for BSMT and or BSMarE. Using an online sample size computer (by Raosoft), the researchers were able to have a sample size of eighty (80), with five (5) percent margin of error and ninety-five (95) percent confidentiality.

2.3 Data gathering tools / Materials and equipment

The researchers used survey forms to collect data. Three (3) instructors have validated this survey form, two (2) are from the General Education Department, and one (1) is from the Maritime Professionals. After the validation, the researchers conducted a pilot testing involving eleven (11) fourth-year cadets, which is at least 10 percent of the population, to check errors and see whether necessary corrections and improvements are to be done on the survey form. Revisions have been made, and the survey form has undergone revalidation with the same validators. After which, the survey form has been approved for actual floating.

2.4 Data gathering procedure

After the validation of the final survey form, the researchers collected the data through a guided survey. The researchers discussed the contents to every respondent part by part, one researcher is to one respondent, to assure that the data would be entered and gathered correctly. The researchers conducted their data gathering methods in the Study Room of the Old Dormitory of the CGSO Campus. The respondents are divided into equal percentage per batch: eighty (80) percent on each batch; First Batch, Second Batch, and Deferred cadets.

2.5 Data analysis or treatment of data

The researchers utilized the internet in transferring all raw data from the questionnaire to the online forms. Through this online form(s) the data were automatically sorted which the researchers used for comprehensive data analysis. The researchers consulted a statistician to analyze the data. The data were treated under a computer program called SPSS to answer the problems of the study. The data were subjected to statistical tools, simple descriptive statistics such as getting the frequency and median were used to analyze and interpret the gathered numerical data on this research.

3 RESULTS AND DISCUSSION

Table 1: Delaying Factors Before Embarkation for Shipboard Training of MAAP cadets

| FACTORS | DESCRIPTIVES | | DURATION OF DELAY (MONTHS) | | | | | |
|----------------------|--------------|------------|----------------------------|---------|---------|---------|---------|-----|
| | FREQ | % OF CASES | 0-1 | > 1 - 2 | > 2 - 3 | > 3 - 4 | > 4 - 5 | > 5 |
| Medical | 11 | 14.30% | 9 | 1 | | | | 1 |
| In-house Training | 48 | 62.30% | 39 | 7 | 1 | | | 1 |
| Sponsorship | 22 | 28.60% | 4 | 5 | 2 | 3 | 3 | 5 |
| Vessel Assignment | 48 | 62.30% | 8 | 10 | 5 | 9 | 4 | 12 |
| Company Policies | 23 | 29.90% | 16 | 2 | 1 | 4 | 1 | 1 |
| Training Ship | 5 | 6.50% | 1 | 2 | | | 1 | 1 |
| STCW Requirements | 34 | 44.20% | 31 | 3 | | | | |
| Company Requirements | 48 | 62.30% | 43 | 2 | 1 | 1 | | |
| Behavioral | 1 | 1.30% | 1 | | | | | |
| Financial | 2 | 2.60% | 1 | 1 | | | | |
| Personal Decision | 17 | 22.10% | 6 | 3 | | 1 | 2 | 5 |
| Others | 1 | 1.30% | 1 | | | | | |

The table above shows the different factors that delay the cadets, prolonging the time before their Shipboard Training.

From this data it could be depicted that the three factors of In-House Training, Vessel Assignment, and Company Requirements affected the respondents the most, regarding frequency, occurring at 48 out of the 80 samples and representing over 60% of the 77 respondents who said they were affected during this phase. These are followed by STCW Requirements at f=34, Company Policies at 23 followed closely by Sponsorship at 22.

Table 2: Delaying Factors During and After Completion of Shipboard Training

| PHASE | FACTORS | DESCRIPTIVES | | DURATION OF DELAY (MONTHS) | | | | | |
|-------------------------|------------------------------|--------------|------------|----------------------------|---------|---------|---------|---------|-----|
| | | FREQ | % OF CASES | 0-1 | > 1 - 2 | > 2 - 3 | > 3 - 4 | > 4 - 5 | > 5 |
| Shipboard Training | Sponsorship | 2 | 3.60% | 1 | | | 1 | | |
| | Contract / Vessel Assignment | 54 | 96.40% | 18 | 11 | 7 | 7 | 2 | 7 |
| | Company Policies | 19 | 33.90% | 7 | 7 | 1 | | 1 | 2 |
| | Personal Decision | 12 | 21.40% | 5 | 1 | | | 2 | 2 |
| | Other | 2 | 3.60% | 1 | | | | | 1 |
| Post Shipboard Training | Medical | 28 | 50.00% | 23 | 2 | 1 | | | 1 |
| | Company Policies | 22 | 39.30% | 12 | 4 | 2 | | | 4 |
| | Behavioral | 2 | 3.60% | | 1 | | | 1 | 1 |
| | Enrolment | 37 | 66.10% | 10 | 1 | | 6 | 1 | 18 |
| | Personal Decision | 10 | 17.90% | 5 | | | 3 | | 2 |

Table 2 under the phase Shipboard-Training illustrates the occurrences of delaying factors experienced by cadets during Shipboard Training and while the phase Post-Shipboard-Training shows delaying factors experienced by cadets after completing Shipboard Training.

It is apparent from this table that majority of the cause of the delay of cadets fall under contract and Vessel Assignment, of which more than 96.4% of the 57 cadets that indicated to have delays during this period have been affected by the said factor. On the far second, with f=19 (33.9% of the cases) is company policies followed by company policies with 21.4% occurrence among the cases at f=12. From the data in Post-Shipboard Training, it is clear that Enrollment considerably occurs among cadets to cause delays. Of the 56 cadets who said they were affected during this period, 37 (66.1% of the cases) suffered from this factor. Medical factors ranked second during this stage while company policies ranked second, occurring at f=28 (50%) and f=22 (39.3%) respectively. (See Appendix B and C for a detailed projection of the data)

Table 3: Delays Before, During and After Shipboard Training

| TRAINING PHASE | MEDIAN (MONTHS) |
|----------------|-----------------|
| Pre-Shipboard | 4 |
| Shipboard | 1 |
| Post-Shipboard | 1 |

Table 3 shows the phase as to what phase has the most significant effect in the delay of MAAP cadets

In determining which of the three phases has the most dominant effect in terms of the duration it costs cadets before they can enroll, it is first necessary for the researchers to identify which of the three measures of central tendency, the mean, median or mode, would be most suitable for the data. It is apparent however that Pre-Shipboard-Training training is the most dominant phase in terms of the median duration it takes cadets, and even if the mean or the mode were used, the result would still lead to this phase delaying cadet the most. Shipboard Training and the Post-Shipboard-Training phases are tied with a median of value one month. Had the mean been used, however, the results would turn out a bit differently with the Shipboard Training phase at an average of 2.07 months (62 days) and Post-Shipboard-Training training at 3.3 months (99 days). The mean for Pre-Shipboard-Training-Training is close to the median of 4 months, at 3.71 months (111 days).

2 CONCLUSION

Evident from the findings, it is conclusive that:

1. In-House Training, Vessel Assignment, and Company Requirements are factors with a dominant effect on the delay of embarkation of MAAP cadets for Shipboard Training.
2. Contract and Vessel Assignment has the greatest impact on the delay of midshipmen during Shipboard-Training, while Enrollment has the greatest effect on the cadets' delay on the Post-Shipboard-Training period.
3. Pre-Shipboard-Training is the most critical period in terms of contributing most to Cadet's delays.

2.1 Recommendation

With these results, the researchers recommended that:

1. Shipping Companies, Manning Agencies, and the Academy may organize studies to improve the forecast of Cadet demands, taking into consideration the companies' projected acquisitions, vessel count, trade competitiveness, and even affiliations to other educational institutions or sponsored affiliates. This process will ensure companies do not take in more cadets than they can allow to board their vessels.
2. The Academy may impose policies requiring companies and the cadets to complete a maximum of only twelve months on their Shipboard Training, taking into consideration the duration of the layover in between contracts, as well as other factors that may delay the completion of their training and their return to the academy.

Adopting the tri-semester or quad-semester schemes can reduce the waiting period for cadets for the next cycle of enrolment. The population of enrollees, the influx of cadets as

they return from Shipboard Training, as well as financial and human resources must be considered in this decision.

3. The Academy may conduct a pre-shipboard orientation for the cadets and make them wary of the factors that may cause delays, particularly for the Pre-Shipboard phase so that cadets can be vigilant specifically on the three factors of Company Requirements, In-House Trainings, and Vessel Assignment.

REFERENCES

- [1] CHED. *Commission on Higher Education* [online]. Manila: CHED, 2017. CMO No. 67 s.2017 Revised Policies, Standards and Guidelines for the Bachelor of Science in Marine Transportation (BSMT) and Bachelor of Science in Marine Engineering (BSMarE) Programs. [viewed date 30 November 2017] Available from <<http://web.ched.gov.ph/cmo-67-s-2017-2/-43>>
- [2] CHED. *Commission on Higher Education* [online]. Manila: CHED, 2017. CMO No. 70 s.2017-Revised Policies, Standards and Guidelines for the Bachelor of Science in Marine Transportation (BSMT) and Bachelor of Science in Marine Engineering (BSMarE) Programs. [viewed date 30 November 2017] Available from: <<http://web.ched.gov.ph/cmo-70-s-2017-2/>>
- [3] Singh, M. Marine Insight [online]. 5 Problems Affecting Seafarers Today. [viewed date 12 January 2018] Available from: <<https://www.marineinsight.com/life-at-sea/5-problems-affecting-seafarers-today/>>
- [4] Dizon and Vergara. *Studymode* [online]. Determinants of the Delayed Shipboard Embarkation of MAAP Class 2010-2013 cadets. [viewed date 12 January 2018] Available from: <<https://www.studymode.com/login.php?redirectUrl=%2Fessays%2FDeterminants-Of-Delayed-Shipboard-Training-1484338.html&from=essay>>
- [5] Genutė Kalvaitienė and Viktoras Senčila. OAJI. *Open Academic Journal Index* [online]. Maritime Students' Professional Career Planning Skills Development as Assessed by Lecturers. Baltic Journal of Career Education and Management. ISSN 2345-0193. [viewed date 12 January 2018] Available from <<http://oaji.net/articles/2014/453-1392143300.pdf>>
- [6] Livingstone Caesar. HRPub. *Horizon Research Publishing Corporation* [online]. 2013. Sustaining the Supply of Ship Officers: Making a Case for Succession Planning in Seafarer Recruitment. *Universal Journal of Management* 1(1): 6-12, 2013. DOI: 10.13189/ujm.2013.010102. [viewed date 12 January 2018] Available from: <<http://www.hrpub.org/download/201308/ujm.2013.010102.pdf>>

IMPLEMENTATION OF THE ECDIS SYSTEM: AN OOW PERSPECTIVE AS AN INTEGRAL PART OF EDUCATIONAL IMPROVEMENT

DAVID BRČIĆ, SRĐAN ŽUŠKIN, SANJIN VALČIĆ, VLADO FRANČIĆ

University of Rijeka
Faculty of Maritime Studies
Studentska 2, 51000 Rijeka, Croatia
<http://www.pfri.uniri.hr>
brcic@pfri.hr, szuskin@pfri.hr, svalcic@pfri.hr, vfrancic@pfri.hr

Keywords: maritime navigation, electronic chart display and information system, officers of the watch, knowledge transfer, ecdis eho

Abstract. Current year marks the completion of the Electronic Chart Display and Information System (ECDIS) implementation period. During the past three decades system evolved from its initial purpose to a complex navigation information system support tool. This transition represents substantial step in navigation, and one would expect that all related issues are shaped smoothly. From the very beginning of ECDIS implementation, Officers of the Watch (OOW) are experiencing various issues ranging from functional, operational, educational, legislative and finally, practical. Numerous organizational standards, resolutions, circulars, reports, guidelines and other documents support this fact, as well as number of ECDIS-related marine accidents, detentions and fines.

The proposed paper represents a segment of a systematically carried long-term research aiming at educational process improvement. This aim is to be achieved through specific approach, proper communication and various and subtle activities, always striving at the user-centered, often neglected issues and their solving. The particular research refers to opinions and attitudes of OOWs towards ECDIS mandatory implementation period completion. Individual knowledge has also been examined in terms of new technology perception, as well as understanding of the system. Internationally distributed questionnaire was used for this purpose. Answers were processed and analyzed together with accompanying comments. Results are shown in the context of transitional period, representing a flow of end-user opinions over the years. Observations and findings are presented and discussed. Research results are especially referring to future officers who are given an objective, immediate and critical insight, beside official education and relevant materials. In this way, OOWs are indirectly exchanging their opinions and knowledge with their younger colleagues. This interrelation, accompanied with theoretical background, is one of the center features of the research. The paper concludes with provision of possible guidelines and planned activities towards further educational improvements, but also towards system development as well.

1 INTRODUCTION

'Let go of that grotesque story about system failures and computer unreliability, please. Everything can be solved from the office ashore within two hours.'

- 2nd Officer, Year of birth: 1981, Seagoing/ECDIS experience: 8/6 years, No official ECDIS education, September 16th, 2014.

'The pencil is always a pencil; the divider is always a divider'

- 2nd Officer, Year of birth: 1981, Seagoing/ECDIS experience: 15/5 years, Possession of ECDIS Generic & Type Specific Course Certificate, April 16th, 2014.

'I was learning the whole life that paper charts are the best way (and the safest way) to navigate so this withdrawal is confusing to me at this stage.'

- Chief Officer, Year of birth: 1982, Seagoing/ECDIS experience: 15 /0.5 years, No official ECDIS education, January 11th, 2016.

Mandatory implementation of ECDIS system commenced on July 1st, 2012. During 6 years of transitional period numerous changes were made in order to improve the system and its features, given that variety of issues and problems emerged as lateral effects. The nature of problems varies from technical, legislative, operational but mostly mind-based and educational, being one of largest influential factors.

This study focuses on ECDIS knowledge, operation and OOWs' opinion regarding the system in general, its features and its role as a justified substitution of traditional navigation means. Mentioned was achieved through international questionnaire distributed to seafarers. So far, over three hundred respondents were examined for the study, consisting mainly of OOWs employed on international voyages.

The paper is organized as follows. The background chapter refers to summarized overview of the ECDIS system, providing relevant information for the study. Given that many documents relate to the system, the reader is referred to the references cited. Methodology of the research is presented with main features of the research, past achievements and main goals it relies on, or strives to, respectively. Presented results are summarized and discussed given OOW's point of view, with consideration of main findings calling to desired continuation of the research.

2 BACKGROUND

Main ECDIS involved organizations are International Maritime Organization (IMO) – providing performance standards (system centered), International Hydrographic Organization (IHO), which provides standards regarding electronic data (chart centered) and International Electrotechnical Commission (IEC), providing operational standards, methods and required test results (system centered) [5]. One of the main reasons of electronic displays' introduction was the necessity of real-time tracking of vessels with possibility of displays of *ice and environmental conditions, true position, radar input and chart information* [4]. How it will eventually turn out, the system changed means of navigation, with data integration as a true added value [13]. As a recognized improvement, ECDIS system was officially accepted as meeting carriage requirements of Safety of Life At Sea (SOLAS) Convention in 2002 [10]. According to [14], in May 2015 most of the global fleet of respective vessels (51% and total, and 59% of vessels engaged on international trade) was compliant with the Convention

regulation regarding ECDIS carriage. The system has to be type approved; use up-to-date Electronic Navigational Charts (ENCs); (software) maintained and has adequate back-up arrangements [6, 10].

These regulations allow for navigation without obligation of paper charts possession, reflecting also on nautical publications and other paper documents used through the navigation venture. Here, OOWs are coming to the fore. The handling with the system should be flawless and smooth, which implies unquestionable integrity and reliability of the system, and properly trained and educated operators. Among all stakeholders involved being equipment manufacturers, instructors, chart producers, hardware and maintenance providers, ship owners, related organizations' representatives and inspection executors [12], seafarers can be considered as true system end-users. As the system evolves further, more and more features emerge, drawing attention from basic features and its initial purpose. In general, the system is accepted as such, and this level of acceptance will surely increase over the time. Benefits of the system are recognized, as well as its influence on the workload and navigation. However, certain elements still remain incomplete and ambiguous [1, 16]. Besides technical issues [11, 15] different problems end-users are experiencing are categorized as problems related to charts, navigation & positioning problems, handling problems and insufficient knowledge [2]. As for mandatory Generic ECDIS course, measurable amount of opinion was observed regarding insufficiency of 40 hours [3, 18], as prescribed in the relevant IMO Model Course 1.27 [8]. Survey on basic safety settings and primal system features showed a certain level of misinterpretation between OOWs [17, 2].

3 THE SURVEY

During years, authors initialized and maintained a two-way communication with OOWs in terms of feedback development, one of which is the ECDIS EHO (*Experience, Handling and Opinion*) questionnaire containing basic, advanced and functional questions. This part of the research elaborates OOWs' experience and work with the ECDIS system through years of implementation period, with key points referring to their opinion on paper chart withdrawal and features of ECDIS navigation as compared to traditional means.

As to date present, the questionnaire was fulfilled by 271 active OOWs employed on vessels subject to ECDIS carriage requirements¹ (Figure 1): 89 Masters (M), 66 Chief Officers (1/O), 55 Second Officer (2/O), 10 Third Officers (3/O), 22 Apprentice Officer (C) and 29 Undefined respondents (U). Questions were conceived as requiring a YES/NO answer primarily, but also providing the possibility for descriptive answers. Apprentice Officers were considered for the study as well. A *NA (not applicable)* refers to ambiguous answer, or the column remained blank.

¹ Total number of 304 respondents was filtered excluding other stakeholders not directly related to the system.

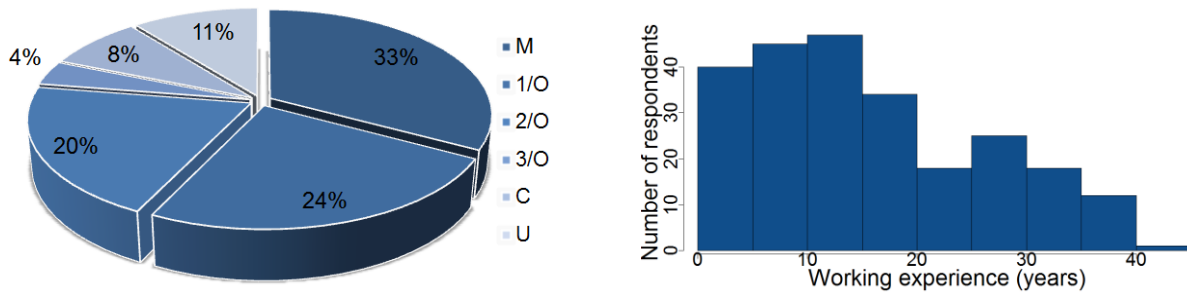

Figure 1: Profile of respondents (left) and distribution of their seagoing experience (right)

Respondents' experience (in years) ranges from 0.5 to 41, with the mean value of 16.8, standard deviation of 11 and the median amounting to 15. The following questions were used for the study:

- *Do you agree with the fact of withdrawal of paper charts from the service, if certain conditions are met regarding the system, i.e. there is no further obligation to possess the same? (abbreviated further as Q1)*
- *Do you think that there are still advantages of paper charts and traditional navigation means over ECDIS/ENC? (abbreviated further as Q2)*

3.1 Results

In general, over half of respondents agree with the paper chart withdrawal. At the same time a majority of OOWs believes that there are still advantages of paper charts over ECDIS system. Share of Q1 answers is presented in Table 1 and on Figure 2, respectively.

Table 1: Share of answers on Q1

| Rank | M | 1/O | 2/O | 3/O | C | U |
|------|----|-----|-----|-----|----|----|
| Yes | 39 | 34 | 37 | 5 | 11 | 14 |
| No | 46 | 28 | 16 | 2 | 9 | 15 |
| NA | 4 | 4 | – | 3 | 1 | – |

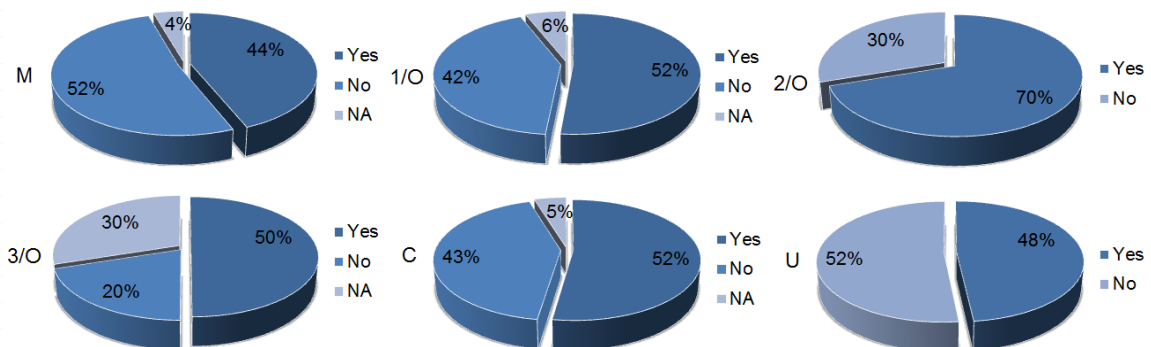

Figure 2: Share of answers (in %) among ranks considering Q1

There is similar share among all ranks, except that in *Masters* and *Undefined* group the answer *NO* prevailed. Most dispersed share is present in *3/O* group, while the situation is straightforward with *Second Officers*.

As for Q2, the overall share is presented in Table 2 and on Figure 3, respectively.

Table 2: Share of answers on Q2

| Rank | M | 1/O | 2/O | 3/O | C | U |
|------|----|-----|-----|-----|----|----|
| Yes | 52 | 39 | 33 | 4 | 13 | 15 |
| No | 26 | 22 | 13 | 3 | 2 | 9 |
| NA | 11 | 5 | 9 | 3 | 7 | 5 |

Advantages of paper charts over ECDIS are recognized by majority of respondents including *2/O* group, while most dispersed answers are present with *3/O*, as before.

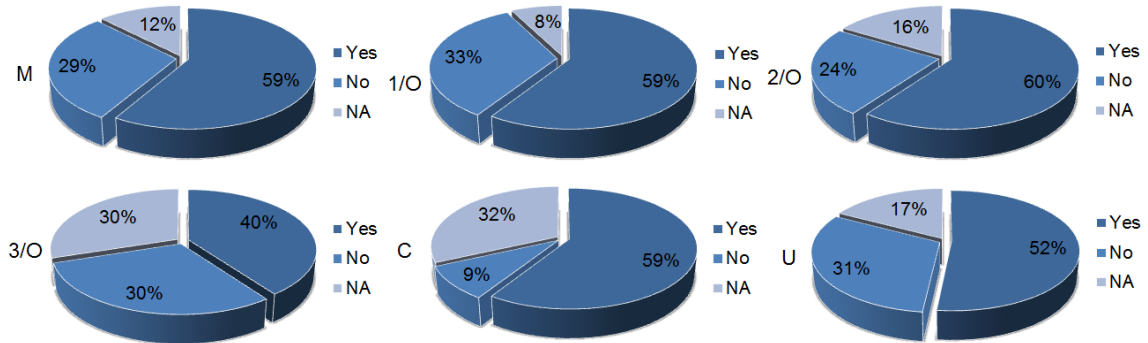

Figure 3: Share of answers (in %) among OOW ranks considering Q2

This general presentation has been further divided according the year of survey completion, thus forming four representative groups² (Figure 4 and Table 3, respectively); the number of respondents in each group (year) is equivalent to 100%, with relative share of answers distributed within.

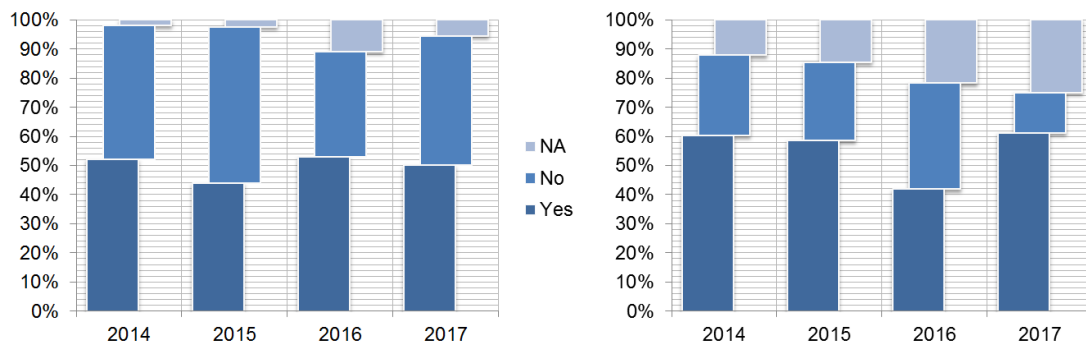

Figure 4: Share of answers on Q1 (left) and Q2 (right) through elaborated period

² Recent year (in time of writing) was not considered for the survey.

Table 3: Relative share of answers on Q1 and Q2

| Q1 | | | | | Q2 | | | | |
|------------|------|------|------|------|------------|------|------|------|------|
| A/Y | 2014 | 2015 | 2016 | 2017 | A/Y | 2014 | 2015 | 2016 | 2017 |
| Yes | 0.52 | 0.44 | 0.53 | 0.5 | Yes | 0.60 | 0.58 | 0.42 | 0.61 |
| No | 0.46 | 0.54 | 0.36 | 0.44 | No | 0.28 | 0.27 | 0.36 | 0.14 |
| NA | 0.02 | 0.02 | 0.11 | 0.06 | NA | 0.12 | 0.15 | 0.22 | 0.25 |

This classification was made in order to find eventual regularities that should form according to time passing and acceptance of the system, obtaining sort of confirmation with increased number of seafarers recognizing its benefits. However, another confirmation took place, although more indeterminate and less defined. In 2016 there is a significant deviation in trend with most pronounced withdrawal agreement (Q1). Afterwards, the share of answers returns as in previous years. In 2017, a sudden increase in affirmation of paper charts was back noted. As for advantages over ECDIS system (Q2), the confirmative answer prevails over the years, with increase of undefined (*NA*) answers. Accompanying comments on respective answers are summarized as follows. In this context, respondents can be categorized as *system supporters*, *traditionalists* and *restrained*.

3.2 Discussion on OOW viewpoints and opinions

Several allegations can be considered as common (Table 4). Main features being specific outlines were compared, showing dissent in opinions. Conditional category of answers refers to supporters who consider the system as paper chart equivalent, however after certain conditions are fulfilled.

Table 4: Summarized OOW comments (table key points are referring to ECDIS system)

| Traditional supporters | System supporters |
|---------------------------------------------------------------------|----------------------------------|
| Unreliability | Ease of usage |
| Underdevelopment | Future of navigation |
| Viruses and attacks | Better accuracy |
| ENC legibility & insufficient coverage | Execution of navigational tasks |
| No standardization & many functions | Technical improvement |
| Information overload | Contribution to safety |
| Small displays & poor overview | Time consumption |
| Human error increase | Human error reduction |
| Best scenario: ECDIS & APC | ECDIS & APC scenario as needless |
| Over-reliance | |
| Lack of knowledge | |
| Conditional statements | |
| Increase of minimum standards | |
| Proper implementation of rules | |
| On demand service, satellite-availability, on-board charts printing | |
| Increase of ECDIS reliability | |
| Standardization and simplification | |
| Improved education and training | |

As for restrained group, advantages of paper charts over ECDIS exist, however they vanish as the time goes. They recognize the significance of implementation period and time required for proper settlement of the system as primary navigational mean, consciously stating that both means represent navigational aids only.

As a general observation present in each group, paper charts should be always kept on-board as a back-up (mainly small scale folios, as stated). Several respondents are stating certain issues with ENC service that have to be solved. A Master-respondent states that *'Paper charts keep officers busy and more focused on navigation tasks'*. Over-reliance is a serious problem, already recognized as a threat. If not handled correctly, any new critical equipment can be harmful, leading to a display-oriented end-user, without sufficient outlook and awareness. Issues with system alarms are worth considering as well. As noted, a large number of alarms make OOWs more relaxed and inattentive (as opposed to work with paper charts). On the other hand, other respondents find system alarms disturbing.

4 FINAL CONSIDERATIONS AND FURTHER WORK

As a primary navigational mean, the ECDIS system is mainly accepted, and this appreciation should increase over time. However, opinion over the years does not support this fact completely. A measurable level of uncertainty and confusion is found among answers. The lack of knowledge can be distinguished as most pronounced issue, potentially leading to further problems. Therefore, besides regulated official education and training, it appears a need for further development of the teaching process regarding the ECDIS system and its related elements. The proposed study provides a possibility for identification of most *vulnerable* respondents, or category of respondents, respectively.

So far, the ECDIS EHO research resulted in several scientific contributions, but also new courses and studies related to navigation information systems onboard vessels. For the purpose of this paper general analyses were made. Future activities imply elaboration of respondents according to their experience with the system and the level of education. The research is devoted to present and future officers of the watch, providing a segment of real and varying situation which their colleagues are experiencing. An OOW perspective presented in the paper serves as additional tool providing tangible and real feedback, and it is applicable to be incorporated in any educational process. The presented methodology and research results refer to development of critical thinking prior to actual contact with system handling.

ACKNOWLEDGMENTS

This work has been financially supported by University of Rijeka under the Faculty of Maritime Studies projects. Authors are grateful to all the officers of the navigational watch on their time and willingness for the fulfillment of the survey, discussions and their opinions. Authors believe that their answers have an immense significance for the appropriateness of the research deliverables.

REFERENCES

- [1] Brčić, D.; Kos, S.; Žuškin, S. Navigation with ECDIS: Choosing the proper secondary positioning source. *TransNav: International Journal on Marine Navigation and Safety of*

- Sea Transportation*. September 2015, 9(3). 317-326.
- [2] Brčić, D.; Kos, S.; Žuškin, S. Partial structural analysis of the ECDIS EHO research: The handling part. In: *Proceedings of the 24th International Symposium on Electronics in Transport, 2016: ISEP'24*. Ljubljana: Electrotechnical Association of Slovenia & ITS Slovenia, 2016, pp. 80-87.
- [3] Brčić, D.; Žuškin, S.; Barić M. Observations on ECDIS education and training. In: *Proceedings of 12th International Conference on Marine Navigation and Safety of Sea Transportation, 2017: TransNav'12*. London: CRC Press, 2017, pp. 29-36.
- [4] Hamilton, A. C.; Nickerson, B. G. *The Electronic Chart*. Fredericton: University of New Brunswick. Department of Geodesy and Geomatics Engineering, 1982. TR102.
- [5] Hecht, H. and others. *The Electronic Chart: Functions, Potential and Limitation of a New Marine Navigation System*. Lemmer: GITC, 2006.
- [6] International Hydrographic Organization. *Information on IHO Standards related to ENC and ECDIS. Version 1.1*. Monaco: IHO, 2017.
- [7] International Hydrographic Organization. *Current IHO ECDIS and ENC Standards* [online] Monaco: IHO, 2018 [viewed date: May 1st, 2018]. Available from: <http://bit.ly/2pjmCyW>.
- [8] International Maritime Organization. *Model Course 1.27: Operational use of Electronic Chart Display and Information System*. London: IMO, 2009.
- [9] International Maritime Organization. *MSC.232(82): Adoption of the revised performance standards for Electronic Chart Display and Information Systems (ECDIS)*. London: IMO, 2006.
- [10] International Maritime Organization. *MSC.282(86): Adoption of amendments to the International Convention for the Safety Of Life At Sea, 1974. Annex 1*. London: IMO, 2009.
- [11] International Maritime Organization. *NCSR 2/22/2: Report on monitoring of ECDIS issues by IHO*. London: IMO, 2009.
- [12] International Maritime Organization. *MSC.1/Circ.1503 Rev.1: ECDIS – Guidance for good practice*. London: IMO, 2017.
- [13] Sabelis, H. Voyage planning in ECDIS. *International Hydrographic Review*. September 1999, 76(2). 41-48.
- [14] United Kingdom Hydrographic Office. *Majority of global SOLAS fleet now ECDIS ready*. Press release. London: UKHO, 2016.
- [15] Weintrit, A. ECDIS issues related to the implementation of the carriage requirements in SOLAS Convention. *Archives of Transport System Telematics*. February 2015, 8(1). 35-40.
- [16] Weintrit, A. International recent issues about ECDIS, E-navigation and safety at sea: Introduction. In: Weintrit, A., ed. *International recent issues about ECDIS, E-navigation and safety at sea*. Boca Raton: Taylor & Francis Group Ltd, 2011, pp. 9-12.
- [17] Žuškin, S.; Brčić, D.; Kos, S. Partial structural analysis of the ECDIS EHO research: The safety contour. In: *Proceedings of 7th International Conference on Maritime Transport, 2016: MT'07*. Barcelona: UPC, 2016, pp. 246-262.
- [18] Žuškin, S.; Brčić, D.; Šabalja, Đ. A contribution to improving the standards of ECDIS training. *Pomorstvo - Scientific Journal of Maritime Research*. June 2013, 27(1). 131-148.

INTERACTIVE ROOT CAUSE ANALYSIS (IRCA) AS A PRACTICAL TOOL FOR DEVELOPING MANAGEMENT SKILLS (FOR MASTERS IN NAVIGATION)

MARINA CHESNOKOVA

PhD, Head of International Cooperation Department, Senior Lecturer of English Language Department
National University “Odessa Maritime Academy”
8, Didrikhson str. Odessa Ukraine 65029
e-mail: fad@onma.edu.ua , <https://www.onma.edu.ua>

OLGA MONASTYRSKAYA

PhD, Head of English Language Department
National University “Odessa Maritime Academy”
8, Didrikhson str. Odessa Ukraine 65029
e-mail: monastyrskaya@gmail.com , <https://www.onma.edu.ua>

JULIA MONASTYRSKAYA

PhD, Senior Lecturer of German Language Department
Odessa National University named after I.I. Mechnikov
24/26, French Boulevard Odessa Ukraine 65058
e-mail: Jmonastyrskaya@gmail.com

Keywords: problem-solving approach, management level, situational awareness, accident investigation, Root Cause Analysis

Abstract. Most accidents are caused by human error, not technological or mechanical failure, the immediate cause is very often that a person made a disastrous decision. As for the management level **the accident investigation** is the most prominent part of the curriculum for Masters in Navigation for acquiring professional English skills in National University “Odessa Maritime Academy”.

For the teaching strategy the 4-step approach for solving a problem can be effective and useful. The use of all 4 stages can vary and depend on the exact task in the definite field. Masters in navigation should look deeper to figure out the cause of the problem, fix the underlying systems and processes so that it goes away for good.

The technique of **Root Cause Analysis (RCA)** is widely used in accident investigation by shipping companies to prevent recurrence. RCA has proven to be a powerful loss-prevention tool and allows crewmembers to discover the true root cause of a casualty. The purpose is to raise situational awareness of officers about the reason why accidents occur. If the root cause can be established and rectified, the risk of accident reoccurring is substantially reduced.

The problem-solving approach focuses on the analytical ability of Masters to find correct professionally-grounded solution based on theoretical knowledge and practical experience on board the vessel.

INTRODUCTION

As far as we can determine, there is no generally accepted definition of what **Root Cause Analysis (RCA)** is. Therefore, we offer the following as possible definitions, one of them at least communicates what is meant by the concept.

One of the definition is that **Root Cause Analysis (RCA)** is a structured investigation that aims to identify the true cause of a problem and the actions necessary to eliminate it [1, p.11].

The term of **Root Cause Analysis (RCA)** is a comprehensive term encompassing a collection of problem solving methods used to identify the real cause of a non-conformance or quality problem. Root Cause Analysis is the process of defining, understanding and solving a problem. The root cause has also been described as an underlying or fundamental cause of a non-conformance, defect or failure. Furthermore, the term “root cause” can also be referred to as the precise point in the causal chain where applying a corrective action or intervention would prevent the non-conformance from occurring [2].

Root Cause Analysis (RCA) is a popular and often-used technique that helps people answer the questions of **WHY** the problem occurred in the first place. It identifies the origin of a problem using a specific set of steps to find its primary cause. The main things to determine are: what happened; why it happened; what actions to reduce the likelihood that it will happen again.

This technique is widely used in accident investigation by shipping companies to prevent recurrence. RCA has proven to be a powerful loss-prevention tool and allows crewmembers to discover the true root cause of a casualty.

The problem-solving approach focuses on the analytical ability of Masters to find correct professionally-grounded solution based on theoretical knowledge and practical experience on board the vessel.

Having good strong problem-solving skills can make huge difference to future career of an officer. Most of all human error types on ships are caused by making ineffective solutions with sometimes painful consequences [1, p.2-3].

APPROACHES TO ROOT CUASE ANALYSIS (RCA)

Under STCW Code (A-II/2) deck officers and Master must use leadership and managerial skills. The Code emphasizes the necessity to know and be able to apply effective communication on board and ashore; obtain and maintain situational awareness in respect of effective resource management. Special attention is to be paid to applying decision-making techniques such as situation and risk assessment, identifying and generating options, selecting course of action and evaluating of outcome effectiveness [3, p.35].

Situational awareness of every crewmember on board the vessel and safety culture provided by the company and being followed and monitored by Master can guarantee the successful and safe performance of the voyage. It can be illustrated by the results presented by IMO Secretariat Report which states that individual casualties have reduced from 1942 in 2008 up to 1051 in 2012. IMO casualties and incidents database shows that from 2013 up to 2016 the number of cases with vessels have halved from 433 to 206 as shown in Figure 1 and Figure 2. [4]

IMO Casualties & Incidents Database Number of Cases (Vessels)

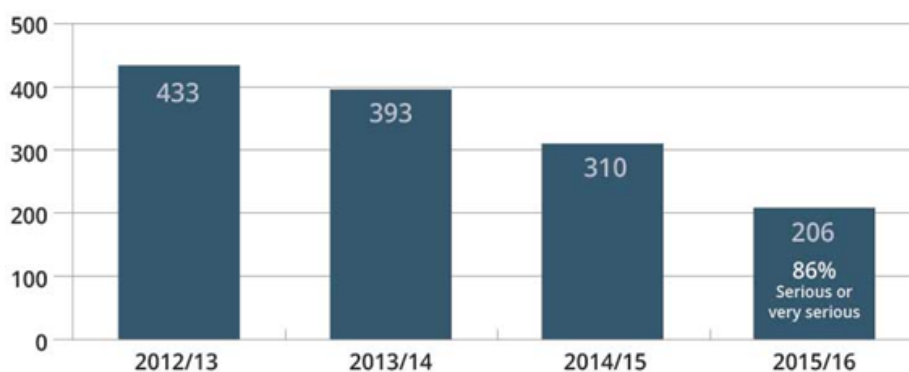

Figure 1: Number of cases (vessels)

Lives Lost-Reported by the IMO Secretariat Individual Casualties

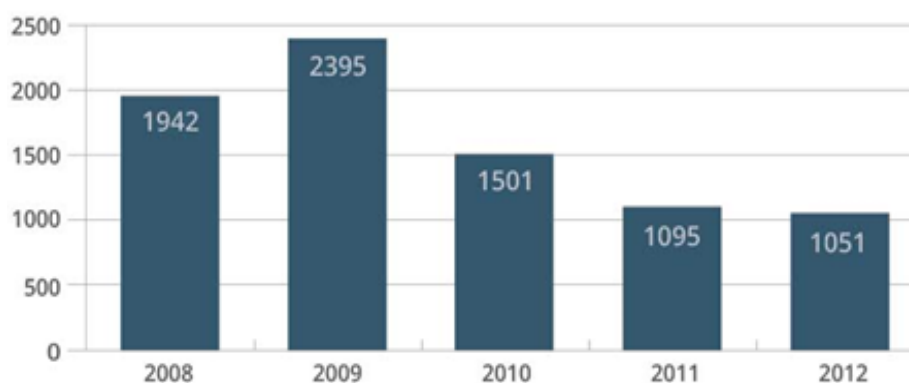

Figure 2: Individual Casualties

The STCW Convention and Code define the minimum standards of competence of seafarers. There are seven functional areas, at three different levels of responsibility provided by STCW Code. The levels of responsibility are: **management level** (applies to senior officers); **operational level** (applies to junior officers); and **support level** (applies to ratings forming part of a navigational or engine watch) [5, p.122]. Master programmes are implemented by universities and academies on the second stage of higher education. These programmes imply the graduates' ability to solve difficult professional tasks in complex. Master programmes additionally imply acquiring knowledge of innovative type and skills of independent research.

WHY DO WE NEED ROOT CAUSE ANALYSIS (RCA)?

Most accidents are caused by human error, not technological or mechanical failure, the immediate cause is very often that a person made a disastrous decision. As for the

management level **the accident investigation** is the most prominent part of the curriculum for Masters in Navigation for acquiring professional skills in National University “Odessa Maritime Academy”.

All accidents, incidents and near misses should be obligatory reported to the office and be investigated, analyzed and discussed afterwards during safety meetings.

Unfortunately, 71% of all human error types on ships are situational awareness related problems. Situation Awareness (SA) acts as team working and effective decision-making aspect. **Situation Awareness** is the ability of an individual to possess a mental model of what is going on at any one time and also to make projections as to how the situation will develop. An often cited definition is; “... the perception of the elements in the environment within a volume of space and time, the comprehension of their meaning, and the projection of their status in the near future” [6, pp. 401-411].

Onboard safety culture is the foundation for safety needs to be established in the company’s culture. The successful implementation of effective safety culture is of primary importance for every seafarer onboard the vessel. That is a must for everybody to understand the relationship between unsafe acts and serious incidents that may result with loss of life.

The **main purpose of accident investigation** is to improve safety performance by:

- 1) exploring the reasons for the event and identifying both the immediate causes and underlying causes;
- 2) identifying the remedial action to improve the safety management system by improving risk control, preventing a recurrence and reducing financial losses.

The mandatory points which are a must for every investigation report are **root cause analysis and preventive or remedial actions**.

The root cause can be defined as the most basic cause that can be reasonably identified that management has control to fix, and when fixed, will prevent, or significantly reduce the likelihood of the problem's recurrence. A root cause is a factor that caused a nonconformance and should be permanently eliminated through process improvement.

WHAT IS THE STRATEGY OF ROOT CAUSE ANALYSIS (RCA)?

This the question we’d like to raise and draw your attention concerning safety of maritime transportation for all parties involved, cut of financial losses, safety of human lives and property.

RCA is a collective term that describes a wide range of approaches, tools, and techniques used to uncover causes of problems. It’s a method of problem solving used for identifying the root causes of faults.

RCA is a popular and often-used technique that helps people answer the question of **WHY** the problem occurred in the first place. It identifies the origin of a problem using a specific set of steps, with associated tools, to find the primary cause of the problem, so that you can:

1. Define what happened;
2. Determine why it happened;
3. Figure out what to do to reduce the likelihood that it will happen again.

RCA has proven to be a powerful loss prevention tool and allows crewmembers to discover the true root cause of a casualty. The purpose is to raise situational awareness of officers about the real and true reason **WHY** accidents occur. If the root cause can be established and rectified the risk of the accident reoccurring is substantially reduced.

The problem-solving approach focuses on the analytical ability of masters to find correct professionally-grounded solution based on theoretical knowledge and practical experience on board the vessel.

The highest-level cause of a problem is called the root cause is shown on Figure 3:

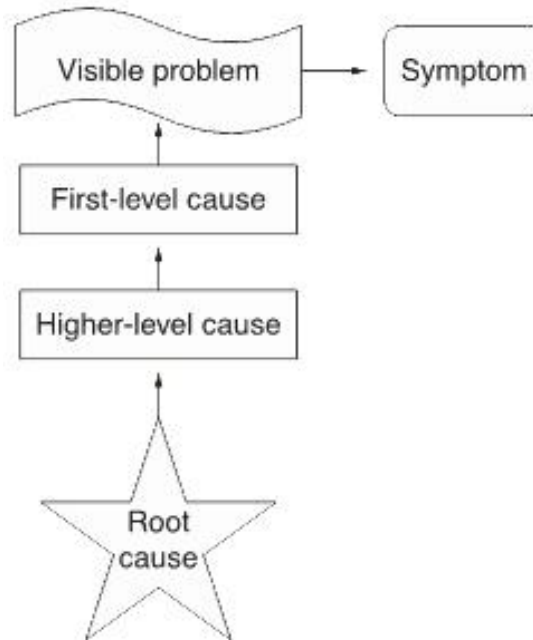

Figure 3: The scheme of the Root Cause

The root cause is “the evil at the bottom” [1, pp.1-19] that sets in motion the entire cause-and-effect chain causing the problems. It’s essentially based on 4 general principles:

1. Define and describe properly the event of the problem (**5 why’s technique**).

5 WHY’s method, in its turn, can be the separate subject for investigation. This is an analytical tool, originally used by the Toyota Motor Corporation, designed to find and identify one or several root causes to a problem. It’s applied nearly in all branches and fields of human life.

The main philosophy of this advanced logical and analytical approach is to teach how to solve a problem by asking “ Why?” Five times successively you move beyond symptoms and delve deep enough to understand the root cause(s). By the time you get to the fourth of fifth “Why?” you will probably be looking directly at management practices. A “Why?” can have several possibilities and each answer has to be looked into for likely root causes.

However, the “ Five Why’s” tool does not provide a resolution to the problem itself, but it is an excellent tool to get an analysis going. The “ Five Why’s” method relies heavily on experience, as it draws on the opinions and observations of the people performing the task.

2. Establish a timeline from normal situation until the final crisis or failure.

3. Distinguish between root causes and causal factor.

4. Once implemented, RCA is transformed into a method of problem prediction.

HOW TO PERFORM ROOT CAUSE ANALYSIS (RCA)?

Let's follow the step sequence based on the case history using 5 Why's analysis.

The vessel was preparing for departure and the mooring parties were standing by forward and aft. The master gave the order to let go all lines and the 2nd officer, who was at the forward mooring station, gave the order to let go both headlines. One of the Abs who was working in front of the mooring winch put the mooring line on a hook on the roller bollard instead of around the roller, which was the normal procedure. An OS was operating the mooring winch but he couldn't see the AB who was handling the line because of the large mooring winch.

For some unknown reason the 2nd officer gave the order to heave in both headlines while one of them was still attached to the shore bollard. It's imperative that the person in charge of the mooring operation has complete situational awareness.

The headline tightened very quickly and it came off the bollard hook and hit the AB hard in the waist. The AB was wearing correct PPE equipment (helmet, safety shoes, coverall and gloves) but this didn't protect him against the snap from the mooring rope. The master believed that the main reason for the accident was because the mooring team wasn't vigilant enough.

Mooring accidents are unfortunately not uncommon but can usually be avoided if the mooring team follows correct procedures and work as a team with clearly defined duties. It is imperative that the mooring team involved is aware of risks which should be defined in the risk assessment [7].

| | |
|--------------------------------------------------------------------------------------------------------------------------------------------------------------------------------------------------------------------------------------------------------------------------------------------|----------------------------------------------------------------------------------------------------------------------------------------------------------------------------------------------------------------------------------------------------------------------------------------------------------------------------------------------------------------------------------------------------------------------------------------------------|
| <p><u>Step 1. Define the problem</u> What do you see happening? What are the specific symptoms?</p> | <p>AB hit by mooring rope during departure.</p> |
| <p><u>Step 2. Collect Data</u> What proof do you have that the problem exists? How long has the problem existed? What is the impact of the problem?</p> | <p>The vessel was preparing for departure and the mooring parties were standing by forward and aft. The AB received injuries to his back and is unlikely to be able to resume sea duties.</p> |
| <p><u>Step 3. Identify possible causal factors</u> What sequence of events leads to the problem? What conditions allow the problem to occur? What other problems surround the occurrence of the central problem?</p> | <p>The master gave the order to let go all lines. 2nd officer gave the order to let go both headlines. AB put the mooring line on a hook on the roller bollard instead of around the roller. 2nd officer gave the order to heave in both headlines. OS can't see AB because of a big mooring winch. The headline tightened very quickly and it came off the bollard hook and hit the AB hard in the waist.</p> |
| <p><u>Step 4. Identify the Root Cause(s)</u> Why does the causal factor exist? What is the real reason why the problem occurred?</p> | |

| | |
|--------------------------------------------------------------------------------------------------------------------------------------------------------------------------------------------------------------------------------------------------------------------------------------------------------------------------------------------------------------------------------------------------------------------------------------------------------------------------------------------------------------------------------------------------------------------------------------------------------------------------------------------------------------------------------------------------------------------------------------------------------------------------------------------------------------|----------------------------------------------------------------------------------------------------------------------|
| <p>To pass step 4 we can use 5 Why's method.</p> <p>1 WHY? The mooring line was still on the shore side bollard when the order to heave in was given by the 2nd officer, causing the line to snap and hit the AB in the waist.</p> <p>2 WHY? AB had put the mooring line on the hook of the roller bollard instead of around the roller bollard.</p> <p>3 WHY? The mooring party had poor situational awareness as no party member recognized the risk of the mooring line on the hook.</p> <p>4 WHY? The mooring party didn't follow the company's risk assessment and mooring procedures.</p> <p>5 WHY? The company hasn't been able to implement a safety culture onboard the vessel which follows risk assessment and procedures.</p> | |
| <p><u>Step 5. Recommend and implement solutions</u></p> <p>What can you do to prevent the problem from happening again? How will the solution be implemented? Who will be responsible for it? What are the risks of implementing the solution?</p> | <p>Mooring team follows correct procedures and work as a team with duties clarification and correct supervision.</p> |

As a result, we can conclude that **direct and root causes** stem from the **failure of the management** control system and leads to necessity of following SMS on board the vessel for all ranks.

To sum it up, accident investigation can only be fully effective if:

- action is taken to implement recommendations;
- the corrective action is monitored and measured;
- monitoring corrective action means documenting, tracking and validating;
- training is often identified as a solution to preventing the recurrence of a problem.

CONCLUSION

Coming up straight to the main strategies in teaching Professional English for Masters in Navigation and basing on the above-mentioned compulsory concepts for management level for junior officers we'd like to focus on one of the most life-important issue as «Accident Investigation». The purpose of accident investigation is to determine circumstances and causes to improve safety of life at sea and avoid future accidents.

This table incorporates 4 language skills, main content areas and task descriptions which are applicable for teaching the topic "Accident investigation" for Masters in Navigation.

To achieve sufficient results, it's effective to base the development of all language skills on **Presentation and Videofilms** on PPP (Presentation and Practice stages and Production) stage relatively.

"Real life" situations are visualized and have real authentic background. Presentations and videofilms contain ships' particulars, description of the situation, schemes of ships' movement, etc., which result in COLREGs analysis, implementation of safety culture on board by Master, OOW, pilot and crew.

| | | TASK DESCRIPTIONS AND FOCUS | CONTENT AREAS |
|-----------|---------------------------------------------------------------------------------------------------------------------------------------------------------------------------------------------------------------------------------------------------------------------------------------------------------------------|-----------------------------|----------------------------------------------------------------------------------------------------------------------------------------------------------------------------------------------------------------------------------------------------------------------------------------------------------------------------|
| | | LANGUAGE SKILLS | Reading |
| Listening | Understanding gist, main points, detail, function; Speech recording (e.g. SMCP, acting out in professional situations); Note-taking. | | VHF in transmitting or receiving distress, emergency and safety communications, communications with Vessel Traffic Service (VTS) and port control, communications with other ships in collision preventing, communications with shore authorities for port entry, berthing, pilot and tug arrangement, and cargo handling. |
| Speaking | Professional discussion on COLREGs violation; Solving professional problems (possible ways of avoiding close quarters, contacts, grounding, etc.); Analysis of the situation by the injured party; Assessment of types of losses (Actual Total Loss, Constructive Total Loss, Particular Average, General Average). | | External communications: communication with other ships, shore authorities by means of VHF, face-to-face communication with inspectors or surveyors, shipping agents, cargo chandlers, shipyards or ship owners by telephone in some inspections and making phone calls, face-to face communication with pilot. |
| Writing | Drawing up a scheme of ships' movement; Completing reports; Business correspondence. | | Sea protests, letters of protest; Different types of claims; Cargo damage reports; Near miss reports; Accident/incident reports. |

REFERENCES

- [1] Andersen, B. and Fagerhaug, T. Root cause analysis: simplified tools and techniques. ASQ Quality Press, Milwaukee, WI, 2006. pp. 1-19.
- [2] Root Cause Analysis (RCA). Available from: <https://quality-one.com/rca/>.
- [3] Miyusov, M. World Shipping and Maritime Education Standards. In: *Catalogue of International Forum on Seafarers' Education, Training and Crewing*. Odessa, 2014, p. 35.
- [4] Accidents at Sea. Seafarers Rights International. <https://seafarersrights.org/>
- [5] STCW (Standards of Training, Certification, & Watchkeeping for Seafarers) including 2010 Manila amendments. International Maritime Organization; 3rd ed., 2011 edition (March 31, 2011).
- [6] C. Hetherington. Safety in shipping: the human element. In: *Journal of Safety Research* 37, 2006. pp. 401-411.
- [7] Claims at a glance. Frequencies & Severity. IRCA cases. In: *Journal of Swedish Club* 2012. Available from: <https://www.swedishclub.com/>.

KNOWLEDGE MANAGEMENT AT MARITIME HIGHER EDUCATION INSTITUTIONS

VLADO FRANČIĆ*, DAMIR ZEC*, LOVRO MAGLIĆ*, IGOR RUDAN*

*Faculty of Maritime Studies, Rijeka, Croatia, Studentska 2, Rijeka, Croatia

<http://www.pfri.hr>

e-mail vfrancic@pfri.hr zec@pfri.hr maglic@pfri.hr rudan@pfri.hr

Keywords: knowledge management, maritime higher education institution, IMO model course

Abstract: Knowledge management as a process was defined first time in 1991 and during last two decades was considered as one of the most important processes in all organizations where knowledge is created, captured, stored or shared. Beyond any doubt, maritime higher education institutions (MHEI) belong to the type of organizations where the knowledge management is the most important process. However, the knowledge managed by these institutions may belong to several different frameworks. The most important are: professional knowledge as required by STCW Convention and pedagogical knowledge implemented in learning processes. In this paper, the knowledge management options at MHEIs are presented. Particular attention is paid to two fundamental knowledge frameworks managed in every MHEI. The paper also presents differences and similarities regarding knowledge management at institutions, members of the IAMU, participating in IAMU PAES project development and its implementation.

1 INTRODUCTION

According to the Oxford Dictionary, knowledge includes facts, information, and skills acquired through experience or education, the theoretical or practical understanding of a subject. In a philosophy, it is considered as true, justified belief, certain understanding..

The first attempts to capture knowledge, especially experts' knowledge, happened during 1980's when expert systems entered into the focus of many researchers. According to [6], an expert system is a computer system that emulates the decision-making ability of a human expert. In most cases, the knowledge was represented as a set of facts and their relations whereas the facts are quantitative or qualitative characteristics related to an object.

As modern human societies advanced, the knowledge has become much more important. In the early 1990's knowledge was recognized as important business asset, firstly in high-tech companies and lately practically in all entities, either business-oriented or not. Approximately, at the same time, the knowledge management was recognized as a distinctive management process, highly important for overall success of any social entity. One of the first definitions of knowledge management was offered up Davenport [2] who defined it as "the process of capturing, distributing, and effectively using knowledge." Today, there are many definitions of the knowledge management, mostly reflecting the standpoint and goals of the person proposing it. Girard identified more than one hundred different definitions of knowledge management [3].

In this paper, the knowledge management is understood as the process of creating, sharing,

using and managing the knowledge and information of an organization [3]. It is understood that this definition clearly includes all processes taking place in higher educational institutions, including those offering maritime programs.

Knowledge is usually categorized into two types – tacit and explicit knowledge [9]. Tacit knowledge is subjective knowledge and mostly based on personal experience. As such, it also includes cognitive skills, i.e. it is a mixture of facts, relations, beliefs, intuition, and mental models as well as technical skills and emotions. Consequently, in most cases it cannot be easily expressed in words, sentences, number or formulas, etc. On the other side, the explicit knowledge is objective and rational; it can be documented and transferred to others through various media. It can be much more easily expressed and codified, if required.

According to [10], knowledge is created through “knowledge conversion” i.e. through interactions between the explicit knowledge and the tacit knowledge. According to the authors, knowledge is first created within the individuals and then transmitted to other individuals, i.e. group. The process [9] consists of socialization (individuals share experiences), externalization (the conversion of tacit knowledge), combination (articulation of newly created knowledge), and finally internalization (converted to new tacit knowledge).

Knowledge management processes may be defined as those processes that create, share and use available knowledge base of an entity. The complete body of knowledge of an institution is the subject to different knowledge management processes and it is recognized as its institutional intellectual capital. According to [8] intellectual capital consists of three distinctive constituents: structural capital, relational capital and human capital. Structural capital consists of supportive infrastructure, processes, and databases of the organization that enable human capital to function. According to the [7], relational capital is the value inherent in a company's relationships with its stakeholders and other important constituencies. It also includes knowledge, capabilities and procedures developed from relationships with external agents. Magrassi defined human capital [8] as “the knowledge and competencies residing with the company’s employees” and defines organizational intellectual capital as “the collective know-how, even beyond the capabilities of individual employees, that contributes to an organization.”

It is beyond any doubt that intellectual capital of any higher educational institution is its most important constituent. As an example, the Journal of Intellectual Capital, volume 19, 2018, devoted a whole issue to the intellectual capital in education. It is equally valid for maritime higher educational institutions. In that respect, a particular attention to knowledge management and intellectual capital has to be paid by the MHEIs, particularly IAMU member institutions because they offer not only BSc, but also MSc and PhD programs.

As a part of the Peer-Assisted Evaluation Scheme project, supported by IAMU, the authors of this paper have visited MHEIs in several countries (Canada, Croatia, Nederland, Philippines, Turkey) where the proposed scheme has been implemented in various forms. Based on the collected data it is quite clear that implemented knowledge management procedures are very different in their scope and goals, while all institutions implement the same knowledge frameworks, i.e. STCW Convention as the professional basis, and student-centred outcome-based education. Accordingly, the following findings are based on experience acquired during the above-mentioned visits. In that respect, authors would like to thank once again the hosting institutions for their support, patience, dedication and the learning opportunities.

2 MHEIs AND KNOWLEDGE MANAGEMENT

In all the visited countries, the internal structure of the MHEIs is more or less the same as in other higher educational institutions in that same country. According to [1], it seems that it is more harmonized in countries where the government bodies responsible for education exercise their full authority over all higher educational institutions, and in particular in countries where institutions are financed from the public sources.

On the other hand, the internal structures of MHEIs in different countries vary very much. The main differences from the knowledge management standpoint are as follow:

- Participation of the faculty members in R&D activities (human capital development), either within the maritime or related fields, in some countries it is mandatory for most of the faculty members. On the other hand, in some countries faculty members are expected to devote all their time and efforts only to teaching activities, with no or very limited time to be spent on any form of knowledge formation.
- In some countries MHEIs considerably invest in developing relational capital, mostly through relations with students' associations, shipping companies, alumni, other stakeholder, while in other the majority of relational activities are aimed to the active students as the primary stakeholders.
- In some countries institutions' management consider knowledge management as a core part of their duties. Such countries consider the extending knowledge base and ability of the institution to participate or even to influence global or regional processes as an important part of institutional activities (for example, participation at IMO Sub-committee meetings or in international research programs).

The body of knowledge maintained by MHEIs covers, but is not limited to two subject areas. The first one is the professional (maritime) body of knowledge, mostly covered by the STCW Convention, while the other contains general educational competencies (academic body of knowledge). In addition to these two clearly distinguished bodies of knowledge the institutional body of knowledge might contain some other subject areas, in most cases connected with dominant R&D activities such as consultancies, project management activities, and dedicated training programs.

In all visited institutions the structural knowledge (structural capital) is clearly codified in a form of different rules and regulations, and in particular within the ISO 9000 documents. In some countries, these documents are fully digitized and available to all staff members as real working documents. It has to be emphasized that significant part of the structural knowledge may be imposed by the government body responsible for educational institutions (for example, through accreditation or recognition processes). Usually, this part of the structural knowledge is highly codified.

Contrary to the previously mentioned, relational knowledge (relational capital) is codified in much less extent. The parts of the relational knowledge that were found codified in several institutions are the actual relation with alumni and with shipping companies as the most important external stakeholders. It seems that relational capital highly depends on personal qualities of the most prominent staff members, and as such even if codified cannot be easily transferred.

The procedures aiming to maintain the professional body of knowledge have not been recognized. In all the institutions that were visited, it has been assumed that a valid Certificate

of Competency is adequate proof of professional expertise. However, there are certain requirements that may be accepted as updating activities, for example, embarkation on board training/merchant ships for a certain period of time, certain training courses (i.e. ECDIS), etc.

Activities aiming to maintain the academic body of knowledge are even more unregulated. In most cases, academic training takes place before or immediately after the first employment in an institution, and typically lasts for a few weeks, but there are cases that training lasts only few days following IMO Model Course. Periodic refreshment or an upgrade of academic body of knowledge, especially for staff members having maritime background, is provided only occasionally. In countries where you may commonly find significant differences between salaries on board and in an institution are common, the situation is even more demanding because it is not easy to find seafarers with management experience and willing to join an institution, and any additional pressure actually decreases their number.

It seems that the need to define knowledge management procedures in MHEIs is still not clearly recognized, although knowledge accumulation and knowledge transfer are the core part of any educational institution. However, in all institutions visited, a number of knowledge management activities have been recognized although they have not been codified.

4 GLOBAL STANDARDIZATION OF MARITIME HIGHER EDUCATION INSTITUTIONS' KNOWLEDGE MANAGEMENT

Initially, standardization of the maritime body of knowledge firstly appeared at regional levels, in the North Sea countries as well as in Mediterranean countries. Probably the process started in 18th and 19th century, or even earlier. At the beginning, it was mostly through exchange of good practice and spontaneous standardization of working procedures and later on through codified knowledge¹.

Modern standardization began with adoption of the International Convention on Standards of Training, Certification and Watchkeeping (STCW) in 1978. At the time, most of the merchant ships were relatively small ships, the implemented technology was simple, control functions were relatively primitive, and whole transport system was significantly under-optimized with considerable fail-safe areas to be used in case of necessity. The major step forward happened in 1995 when the first set of amendments to the STCW Convention was adopted. A second set of amendments was adopted in 2010. These amendments considered new ship design concepts but also significant advances in different fields, mostly those dealing with automation, control and optimization of different processes as well as with human resource management.

Probably the most important step forward has been introduced by the mentioned amendments where the specifications of minimum standards of competence for different levels of responsibility and functions on-board have been set-up. Standards are presented in tables with four columns specifying the following: Competence (Column 1), Knowledge, understanding and proficiency (Column 2), Methods for demonstrating competence (Column 3), and Criteria for evaluating competence (Column 4). The way that competencies are described clearly refer to Bloom's taxonomy and learning outcomes as main criteria for evaluating the successfulness of the educational process. In that respect, it is worth noting the

¹ Codified knowledge include books, regulations, rules, manuals, guideline on good practice and any other source containing transferable knowledge.

following:

- (1) The Competence tables only use Knowledge, Understanding and Proficiency to describe the particular competency. Typical verb references denoting higher-level of learning outcomes (Analysis, Synthesis, and Evaluation) are not used. For example, the verb to analyse is used only in connection with analysis of information obtained radar information. Based on that, one may easily conclude that body of knowledge described in the tables contains only simple, repetitive tasks, i.e. tasks that do not require thorough understanding of underlying processes or any higher-level competency.
- (2) The Competence tables do not contain any significant reference to generic (transitional) competencies. For example, the TUNING project [11] described more than 30 generic competencies to be developed and assessed. The only exceptions are the requirements to use the English language for effective communication, leadership and teamwork skills. It has to be emphasized that creative (instrumental) competencies (such as analytical thinking, systemic thinking, critical thinking, creative thinking, problem solving, time management, etc.) are not mentioned.

One may easily conclude that seafarers trained strictly in line with minimal requirements of the STCW Convention will have very tough times if confronted with problems or situations for which they are not specifically trained.

On the other hand, tables of competencies cover quite a wide body of knowledge, and one can argue that it was not possible to specify precisely all the competencies required, especially taking into the account the multitude of jobs and circumstances the seafarers are facing every working day. This is particularly true if recent developments are taken into account (large and highly complex ships, in particular cruisers, containers, LNG carriers, new technologies, highly automated or even autonomous ships, etc.). However, this argument actually emphasizes the importance of generic competencies, in particular those giving the ability to react reasonably in circumstances he or she has never experienced before. Moreover, those competencies are deliberately left out from the tables of competencies. Following the same reasoning, it is easy to conclude that a person fully trained in accordance with given tables of competencies shall not be able to assume management positions on particularly sophisticated ships. In fact, the industry has already recognized the situation and tried to solve the problem by introducing a number of specialized trainings, carried out either in-house or by using external trainers. For example, Gundić et al. counted more than 60 different training programs provided for the management positions on LNG ships in addition to competencies acquired in accordance with STCW Convention [4].

In order to ensure harmonized implementation of the STCW Convention, IMO² “has designed the series of courses to help implement this Convention and, further, to facilitate access to the knowledge and skills demanded by increasingly sophisticated maritime technology”. Each model courses include the Course Framework, General Outline, Detailed Outline, Instructor Manual, Evaluation, and Assessment. Even after a brief look, it is clear that although IMO has done much effort to harmonize the structure of the model courses there are great differences between those model courses. The main differences detected in different model courses are as follows:

² <http://www.imo.org/en/OurWork/HumanElement/TrainingCertification/Pages/ModelCourses.aspx>

- (1) Model courses cover a wide range of educational activities, from those covering management positions (for example Model Courses 7.01 up to 7.04), those covering the subjects required for certain on-board duties (Model Course 1.14 Medical First Aid) or duties on certain ships (Model Course 1.03 Advanced training for chemical cargo operations), all the way the duties that are not part of the Convention at all (Model Course 3.09 Port State control).
- (2) Several model courses have their compendiums, but not all of them. Several compendiums provide the whole body of knowledge from their field (excellent example is Model Course 1.05 Advanced Training for Liquefied Gas Tanker Cargo Operations).
- (3) Model courses without compendium still require prepared course material that is done by each teacher delivering the course.
- (4) Some model courses are well conceptualized with the appropriate and detailed guidance notes while others use only general statements and bulleted statements (draft Model Course on Use of Leadership and Managerial Skills, to be approved during HTW meeting in 2018).
- (5) Older model course mostly do not use Bloom's taxonomy to describe the target learning outcomes. However, some of them provide very detailed teaching material.
- (6) Some model courses uses Bloom's taxonomy but in a very different way. For example, in one model course students (deck and engine officers educating for certificates at management level) are required to "create a management framework based on the aspects of human nature" after listening just few hours of the course.

Regarding the use of Bloom's taxonomy in model courses, it is worthy to mention the submission from China to 2018 IMO HTW Sub-committee meeting, under the title "Proposal on development of an Action Verb Taxonomy for the Detailed Teaching Syllabus applicable to IMO model course development and revision". The proponent calls for unified use of Bloom's taxonomy in different model courses. It is interesting that meaning of the term Proficiency in the tables of competency is extended, and includes not only Application but also Analysis, Synthesis, and Evaluation. It is very questionable whether the definition of the word Proficiency includes reflective knowledge, as defined in the Bloom's taxonomy, and whether such addition can be supported by actual body of knowledge defined in the STCW Convention.

In recent years, the number of model courses proposed for validation to IMO is increasing. For example, in 2014 only five model courses had been proposed while this year (2018) eleven model courses were prepared by Secretariat and proposed to IMO HTW Sub-committee for validation. Many of these model courses are actually revisions of their previous version, but many are also recently developed. In that respect, and having in mind that model courses are predominately pedagogical documents one can ask whether HTW Sub-committee is actually qualified to approve such documents or not, especially taking into account that in many countries model courses are usually taken as mandatory documents [5].

Although majority of model courses cover professional body of knowledge, several model courses cover academic body of knowledge. Probably the most important model courses in that respect are Model Course 6.09 Training course for instructors. It is interesting to follow development of this model course over years. First edition was published in 1991, than the major revision in 2001, and finally the last one in 2016. First edition had 64 pages, the second

one 73 and last one had 82 pages. However, the first edition had the Compendium on 163 pages, the most significant parts being: 3) Development of a learning system, course design, 4) Development of an instructional strategy, 5) Course evaluation and assessment of participants, and 6) Course planning, organization and conduct. According to the new structure, 2016 revision include, a new Part E - Evaluation and Assessment, and significantly extended list of reference materials. Part D – Instructor Manual was changed and significantly reordered by (from 58 pages in 2001 to 32 pages in 2016) excluding some teaching methods and nearly all case studies. Together with Model Course and Compendium, the authors of the first revision also created presentations for each session, specific guidance for teachers and several worksheets and handouts for each session. It seems that authors of the new revisions deliberately decided to offer only the guidance and require of those who will deliver the course to develop their own teaching materials in accordance to the needs. However, the Model Course 6.10 Train the Simulator Trainer and Assessor (2012) retained Compendium on 98 pages and actually has much more practical advices that Model Course 6.09.

It can be concluded that STCW Convention and the accompanied model courses, although not consistent across different subject areas, quite precisely cover professional body of knowledge to be taught in higher maritime institutions. Probably, the additional harmonization of the content of the model courses will be provided in the future. Academic body of knowledge, although having the considerably smaller scope, should be developed beyond standards defined in Model Course 6.09.

When talking about the higher maritime institutions offering education at university level, the level of education specified in STCW Convention and accompanying documents is not enough. Additional efforts should be paid in order to include additional generic competencies and reflective knowledge in the provided programs, in addition to the competencies defined in STCW Convention. In that respect, knowledge management principles, methods and procedures can be useful.

4 CONCLUSIONS

Maritime higher education institutions build their activities on basis of two different bodies of knowledge: professional knowledge, as outlined in the STCW Convention and related sources, and academic body of knowledge. Although not clearly identified, MHEIs have implemented all the important knowledge management procedures: knowledge accumulation and knowledge transfer. Following that, it may be concluded that MHEIs can significantly improve their processes by applying more structured implementation of the knowledge management principles.

STCW Convention as well as the associated model courses, although not consistent across different subject areas, quite precisely cover professional body of knowledge to be taught at maritime education institutions. However, generic competencies, identified as highly required for management positions, are excluded in STCW Convention (apart from few exceptions). Therefore, MHEIs, especially those providing education beyond BSc level, should consider including more generic competencies in their curricula. In addition, despite the efforts of IMO in last few years to harmonize content and methodology used in different model courses, the existing model courses still contain a significant number of inconsistencies, ranging from differences in used terminology up to very different ways of presenting the body of

knowledge. Consequently, MHEIs should be careful when implementing IMO Model Courses, as they only present the minimal standard, not the target level appropriate for university education or required for technologically innovative ships.

Academic body of knowledge, although having relatively smaller scope when compared to professional body of knowledge, is considered not so important and not systematically developed in many MHEIs. Furthermore, there are only few model courses dealing with academic body of knowledge where only the fundamental body of knowledge are presented. Therefore, MHEIs, in particular those offering programs beyond BSc level, should consider implementation of academic standards beyond those defined in STCW Convention and associated model courses.

REFERENCES

- [1] Badrawi, H. and others. *The Management of University Integrity*, Proceedings of the Seminar of the Magna Charta Observatory, Bononia University Press, 2007.
- [2] Davenport, T. *Saving IT's Soul: Human Centered Information Management*. Harvard Business Review, 1994, March-April, 72 (2) pp. 119-131
- [3] Girard, J. *Defining knowledge management: Toward an applied compendium*, Online Journal of Applied Knowledge Management, 2015, 3(1), pp. 1-20
- [4] Gundić, A. Ivanišević, D; Zec, D. *Additional MET programs for the Masters on board LNG carriers*, Proceedings of the 7th International Conference on Maritime Transport, Barcelona: Oficina de Publicacions Acadèmiques Digitals de la UPC, 2015, pp. 131-138
- [5] Horck, J, *International Maritime Legislation and Model Courses*, 4th IAMU Annual General Assembly, Alexandria, 2003, Egypt
- [6] Jackson, P. *Introduction to Expert Systems* (3 ed.), Addison Wesley, Boston, USA, 1998.
- [7] Khavand K.J.; Khavandkar, E. *Intellectual Capital: Management, Development and Measurement Models*", 3rd edition, Ministry of Science, Research and Technology, 2013.
- [8] Magrassi P., *A Taxonomy Of Intellectual Capital*, Gartner Group, Stamford, USA, 2002.
- [9] Nonaka, I. *A dynamic theory of organizational knowledge creation*, Organization Science, Vol. 5 No. 1, 1994, pp. 14-37.
- [10] Nonaka, I; Takeuchi, H. *The Knowledge-creating Company: How Japanese Companies Create the Dynamics of Innovation*, Oxford University Press, Oxford, 1995.
- [11] Sanchez, A.V.; Poblete, R.M. (eds). *Competence-based learning - A proposal for the assessment of generic competences*, University of Deusto, 2008.

MARITIME TRAINING FOR EMERGENT OPPORTUNITIES

Capt. Walt Nadolny

Senior Lecturer, Delegate IMO-MEPC
State University of New York Maritime College
6 Pennyfield Ave, Bronx NY, 08003, USA
email. wnadolny@sunymaritime.edu
web page: <http://www.sunymaritime.edu/>

Keywords: Human Element, Maritime Education and Training, Maritime Environment, Maritime Policies and Issues

INTRODUCTION:

The traditional model for maritime training has been coursework leading toward either a deck or engine credentialed graduate. Given the changing nature of regulation and the introduction of new technologies these lines have become blurred. New positions such as Electro-Technical Officer and Environmental Officer have become standardized over the last decade. Added responsibilities defined within these existing modalities now encompass Safety officer and Safety engineer. This paper will focus upon these positions and the cross training recommended for a deck or engine officer to successfully preform those duties. It will further highlight emerging opportunities.

Environmental Officer

Today's cruise industry represents the strongest growth segment of marine industry employment both aboard and ashore.¹ The position of Environmental Officer is unique to the industry afloat however the responsibilities and training for the job transition well to positions ashore in all maritime segments. The Environmental Officer is the person responsible for the overall environmental compliance, public health and safety on vessels that exceed 8000 passengers and crew, the equivalent of a floating city².

¹ <https://www.cruisemarketwatch.com/capacity/>

² <https://royalcareersatsea.com/pages/environmental>

The knowledge for the position encompasses our traditional training with crossover, particularly for deck students needing emphases in engineering systems. The additional training unique to the position includes- Environmental Management- Environmental Law-Public Health-Marine Pollution-Environmental Hazard Communication. Soft skills needed are public speaking-writing-spreadsheet analysis.

The engineering skill set is particularly important in that the Environmental Officer is legally responsible for vessel emission compliance. That person will sign off that the Oil Water Separator is functioning within MARPOL limits. He will also ensure that air emissions are in compliance, either by monitoring the sulfur content of the fuel *or* the efficiency of the exhaust scrubbers. The Environmental Officer is required to monitor both black and gray water discharges and the functioning of the sewage treatment plant in general. These limits change as a vessel proceeds from MARPOL waters into waters under the jurisdiction of Port State Control or Special Areas as defined by MARPOL. He or she is responsible for the accurate compiling of the garbage record book, monitoring of food discharges and the proper handling of any hazardous or special category waste such as medical waste. The responsibilities of the position also includes the monitoring of all chemical storage areas as well as the proper labeling and hazard communication and training for the crew.

In addition to the aforementioned the Environmental Officer is in charge of environmental training for crewmembers and maintaining records of the training. He or she is responsible for the accurate recording of all records pertaining to the environmental operations of the vessel. This includes:

- Oil Record Book
- Garbage Record Book
- Hazardous Waste Documentation
- Medical Waste Log
- Expired Drug Disposition
- Deck and Engine Logs regarding accuracy of positions
- Monitoring of oily waste discharged ashore
- Monitoring or Implementing a recycling program aboard

The position usually reports to the Master of the vessel with co-reporting to a corporate Vice President for compliance.

Our institution is in the process of taking existing classes both inside and outside ones major to create a certificate program to encompass the required knowledge for the position. Courses recommended are:

- Chemistry
- Ship Systems I (Discusses the environmental systems on the ship)
- Environmental Management
- Environmental Law
- Marine Pollution

These courses as well as a good command of word processing and spreadsheet programs are necessary as well as a comfort level in written and oral communications and public speaking are recommended to comfortably fulfill the role.

Electro-technical Officer:

This position has evolved from the cruise industry into a necessary position on many vessels due to the complex automation fitted. As crew sizes shrink due to automation and engine rooms are virtually unmanned most of the day more ships systems are networked and monitored, even controlled remotely. Indeed in these days of ever increasing levels of automation a thing as simple as a failed network buss can stop a multi-million dollar vessel from operating.

The position is a highly specialized one containing elements of electrical engineering, automated controls, hydraulics, computer networking, network troubleshooting, communication and cyber security. Indeed the 2010 Manila amendments to the STCW code have recognized and codified the training required for the position in regulation III/6 of the code³. A person seeking this position should have demonstrated knowledge of:

- Onboard Computer Networking and security
- Ships propulsion and auxiliary machinery
- Instrumentation and control systems
- High-voltage power systems
- Integrated navigational equipment
- Radio electronics

He or she will be responsible for the efficient operation as well as maintenance and troubleshooting of these and any other integrated systems. The position usually reports to the Chief engineer. On highly complex vessels such as cruise ships, research vessels and drill ships there may be a junior and senior Electro-technical positions onboard.

Many institutions have made the Electro-technical officer training as an add on to the training required for an operational level engineer position. Given the rapid evolution of vessels the position will be in high demand going forward and will likely supplant a watch standing engineer billet.

Safety Officer/Engineer

It is required that every ship appoints a named ships officer or engineer as Safety Officer to handle safety issues related to the ship and the crew⁴. The safety officer should act as the safety advisor on board ships and ensures that all requirements related to health and safety is met. On cruise ships these duties are met by a stand-alone position often working in conjunction with the Environmental Officer.

The ships safety officer makes recommendations to the master on health and safety matters. It is the duty of the safety officer to lookout for potential hazards and

³ Electro-technical Officer is an officer qualified in accordance with the provisions of regulation III/6 of the [STCW Convention](#)

⁴ STCW A-II/1, A-III/1,AIII/6

means of preventing incidents on board ship. Duties also include the facilitation of weekly safety meetings as well as conducting risk assessments and investigations.

Following is the list of items the safety officer must consider during inspection of working environment and condition. This list will should vary according to the design and type of ship. The more complex the vessel, such as a drill ship or cruise ship will entail more complex duties.

- Ensure that all means of access are in safe condition, well lit, and unobstructed
- Warning notices are put in case access is in dangerous conditions or removed for maintenance
- Ensure lock out tag out, hot work and aloft permit conditions are enforced
- All equipment stowed in the access area are properly secured
- The guard-rails are in good condition, secure, and in place
- All fixtures and fittings that cause potential hazards are suitable painted and marked
- All openings through which a person can fall, are fenced suitably
- Working areas should be well ventilated
- The area should be clear off all unwanted items, rubbish, combustible material, oil spill etc.
- All dangerous goods and substances are not left in the area or stored dangerously
- All loose tools, stores and similar items are secured properly
- The machinery system are properly guarded where necessary
- All necessary operating instructions are clearly displayed
- All required safety signs are clearly displayed
- All crewmembers must wear personal protective clothing and equipment
- All protective clothing and equipment are in good condition and used properly
- Ensure that proper steps are being taken to rectify defective equipment
- Adequate supervision is provided for new or inexperienced crew.

It is the duty of the safety officer to check that all statutory regulations and company safety procedures are complied with. He must also ensure that all safety procedures provided by publications and company is followed. It should be noted that in the United States officers could be held financially libel in the case of crew injuries. They may be held criminally libel in the case of a crewmembers death.

Remote Vehicle Operation:

The pace of technology is changing our industry. We have all seen the advent of GPS, ARPA, GMDSS and automation at all levels of marine operations. The next technology coming into the forefront of the maritime domain is Remote Vehicle Operations. As we go forward more and more of human centric positions are being replaced by this technology. The phase in of ROV operations are doing away with jobs

that can be both mundane and hazardous. Divers cleaning hulls will very soon be an obsolete enterprise. Robotic hull cleaning and inspection devices are becoming the norm for in water husbandry. In above water operations aerial drones are being utilized for inspection of masts and cargo gear. Drones are replacing the manual inspection of cargo holds and tanks with multiple sensors and video recording capabilities⁵⁶. This allows for a permanent digital record rather than an inspectors notebook.

Given the advent of these technologies our institutions should make the training available to students as either a minor or a certificate program within a degree.

The Federal Aviation Authority governs the operation of a remote vehicle in the United States⁷. These laws mandate the training required to operate commercial drones, in effect one is considered a pilot.

Subsea remote operated vehicles have been in operation in the offshore oil industry as well as laying sub-sea cables. Generally the operators are highly trained specialists within engineering disciplines. As the cost of the technology has decreased acceptance of ROV's have become widespread within the maritime sphere. The operation of these devices, weather autonomous or directly controlled does not require the technical prowess of the offshore oil and cable laying technologies. It does however require some specialized training and in some cases licensure. There are institutions that do provide the training both domestically in the United States⁸ and globally⁹. In examining the courses offered for either aerial or marine ROV's.

Conclusion:

As global shipping moves into autonomous and semi autonomous vessels courses such as these will ensure our graduates relevance in the rapid environment of change we find ourselves in. Specialization within a traditional discipline will allow for a more rewarding career and position our graduates to keep current and employable. The paths discussed can lead to rewarding shore positions as a mariner transitions out of onboard positions.

The additional training either required or suggested can be accomplished within a university framework. It allows opportunities for interested faculty to do research as well as contribute to the ever-developing regulatory framework. Regulations are currently being developed by classification societies, such as DNV-GL as well as other bodies. These regulations will be codified within the International Maritime Organization framework. The acceptance and understanding will allow institutions within the IAMU a seat at the table and a voice in shaping the future.

⁵ <https://www.dnvgl.com/news/guidance-on-use-of-mini-rov-mou-ballast-tank-inspections-44318>

⁶ <https://www.dnvgl.com/news/in-water-bottom-surveys-by-means-of-remotely-operated-underwater-vehicle-rov-are-accepted-by-dnv-gl-47220>

⁷ Public Law 112-90, Title III subtitle B as well as CFR Part 1, Part 21 H

⁸ <http://www.atlantic.edu/program/degrees/UnmannedAircraftSystemsSpec.html>

⁹ <https://www.theunderwatercentre.com/fort-william/rov-training/rov-courses/>

PATERNALISTIC LEADERSHIP IN A DISTINCTIVE MARITIME WORK ENVIRONMENT: A STUDY AMONG MARITIME STUDENTS

ENDER ASYALI *, RICHARD ALLARD †

* Department of Marine Transportation
Maine Maritime Academy
1 Pleasant St., Castine, ME, 04420 USA
e-mail: ender.asyali@mma.edu, <https://www.mma.edu>

† Department of Marine Transportation
Maine Maritime Academy
1 Pleasant St., Castine, ME, 04420 USA
e-mail: richard.allard@mma.edu, <https://www.mma.edu>

Keywords: Paternalistic Leadership, Maritime Training

1 INTRODUCTION

Formal and structured roles and duties, high turnover rates among crew, high level of stress, demanding and high-risk work, multinational and multicultural crew composition, limited social interaction and social isolation makes the maritime work environment distinctive. In this distinctive work environment, positive paternalistic leadership may be an option for ship captains as an effective leadership style. Traditionally leadership training had been offered in many maritime education institutions but after the introduction of the STCW 2010 amendments, leadership training has become a compulsory and essential part of Maritime Education and Training (MET). Appropriate leadership style will not only improve job satisfaction and morale of seafarers but also will improve safety onboard

Today one of the primary traits that make a good effective leader is his/her ability to appraise and comprehend the constantly changing but distinct nature of a maritime work environment and to adapt their leadership style to this diverse environment. Leaders should have knowledge and competence about as it concerns different types of leadership styles appropriate for the given environment.

On a managerial behavior scale, the Paternalistic Leader leans more toward being an authoritarian while maintain a mild degree of benevolence. It can be theorized that all authority is assumed, and that which is real requires support from above. So it logically follows that one must assume authority first before he/she can lend it in support of others. On one end of the scale is the Autocratic Leader who delegates nothing, doing every task him/her self, and micromanaging subordinates into becoming mere scribes. On the opposite end of the

scale is the Free Reign Leader who delegates everything reserving no authority in him/her self, giving little direction to subordinates but still expecting them to stay on task while performing to at least a minimum acceptable work standard. Though there are obvious differences in manner and approach between the Autocratic and Free Feign Leader, and each may obtain some similar positive goals, they share the same higher risk of having negative impacts on productivity and morale. Each in their own ways tends to stifle motivation for the professional advancement of subordinates, closes the conduit for which institutional knowledge must flow, and limits both tacit and direct communication from leader to follower that: “But for though they may be only one, they are part of a whole family”; having an ethos of stability, standards, and safety.

One example where Paternalistic Leadership’s can have a positive effect is within the professional maritime practice of Bridge Team Management, sometime referred to as Bridge Resource Management. Team Management requires that a leader understand that poor communication between watch-standers makes it difficult to recognize when an error chain is developing and how to break it. For Bridge Team Management to be effective their needs to be a voyage plan that is well understood by all watch team members that creates good situational awareness, and a management style that encourages members of the watch team to speak-up and ask questions when there is a change in the plan. The voyage plan may have errors in the many activities it purports to perform, mistakes in navigational calculations, mistaken or misread information, or cause the discovery of malfunctioning equipment in implementation. The list of elements that could create an error chain is not exhaustive within even the best voyage plan. Poor communication between crewmembers creates error chains, prevents discovering them as they are developing, and can hinder recognizing them when they are present. Paternalistic Leadership is not authoritative to the degree of discouraging one from asking questions and identifying changes in a voyage plan. Quite the opposite is true of Paternalistic Leadership. It enhances the same professional manner of communication that motivates a watch-keeper to be part of a team that participates with the same awareness that breaks an error chain, instills professionalism, and encourages fellow watch standers in a cultural environment of safety to speak-up.

Another instance where Paternalistic Leadership may have a positive value is that it gives consideration to the multicultural differences that may make crewmembers hesitant about following a leader of a different nationality, and questioning the authority of leaders when appropriate. It is common to find crews of different nationalities, each having different cultural values, onboard the same ship. Research first conducted among workers in the same multinational corporation and then in safety-critical systems showed that individuals behaved differently in ways that could largely be explained by their particular nationality or culture [1].

Among the characteristics measured was the extent to which individuals deferred to figures in authority, referred to as “Power Distance.” Speaking in generalities, Asian cultures tend to be more likely to defer to an authority figure than those of Western societies. Everyone has a father, and most were authoritative figures that had a positive influence in their life. A Paternalistic Leader does not stand so close “in parentis” to another that the familiarity breeds contempt, nor does he/she ignore the cultural diversity of others. But it is the same type of strong positive authoritative but nurturing influences of a father that are the qualities of a Paternalistic Leader.

1.1 Paternalistic leadership

Paternalistic leadership has become an important area of research in the leadership literature and received growing interest from organizational researchers around the world in the past two decades [2,3,4,5,6]. Paternalistic leadership is a father like leadership style [7] and combines strong discipline and authority with fatherly benevolence [8]. Authoritarianism refers to leader behaviors that assert authority and control, whereas benevolence refers to an individualized concern for subordinates' personal well-being [3].

Although Paternalistic Leadership originated from traditional Chinese culture [9] and also it is a prevalent cultural characteristic of traditional eastern societies such as China, Japan, India, and Korea [10,11] recent results suggest paternalistic leadership may generalize across cultures [12]. The paternalistic leader takes care of his/her employees like a parent. He/She is involved in every aspect of employees' lives and provides guidance and counseling in professional as well as personal matters [13]. Paternalism is developed to humanize and remoralize the workplace as well as establish more flexible management system instead of rigid and contractual relationships between employers and workers [4,14]. Previous study where the questionnaire developed by Aycan was applied, concluded that paternalistic leadership is highly accepted and supported by Turkish Maritime Students [4,15].

2 OBJECTIVE

A survey tool developed by Aycan [1] was applied to students of Maine Maritime Academy, in order to determine the perceptions of about paternalistic leadership determinants. The main objective of this study is to analyze the paternalistic leadership determinants among groups of maritime students. The analysis is accomplished in three different samples of students: major, class, and gender. Three main hypotheses are developed to test the objectives built on the comparative analysis of the populations:

H₁: Paternalistic Leadership determinants are perceived different by students of different majors.

H₂: Paternalistic Leadership determinants are perceived different by students of different classes.

H₃: Paternalistic Leadership determinants are perceived different by students of different gender.

For each of the hypothesis 21 sub-hypotheses are formulated to analyze the determinants comparatively.

3 RESEARCH DESIGN AND METHODOLOGY

3.1 Data collection and sampling

To test the hypothesis of the research, a questionnaire consisting of 2 different parts is applied. The first part of the questionnaire covers totally 21 statements on paternalistic leadership which were developed by Aycan [4].

The second part covers 3 questions on the information about major, class and gender of the student for the purpose of profile establishment. Respondents were asked to rate the extent

which they agreed with the stated characteristics of ideal leadership on a 5-point Likert scale (5= “strongly agree”; 1= “strongly disagree”).

The research was applied to Senior and Junior (Marine Transportation Operations) MTO and (Vessel Operations and Technology) VOT students in 2016-2017 spring and fall semesters and 2018 spring semester during their casualty analyses course and to Freshmen MTO, VOT and ME (Marine Engineering) students in March 2018. 288 questionnaires were collected, out of 341 students, 16 questionnaires were disqualified, and a total of 272 questionnaires with 80% response rate were processed.

Data processing is maintained by the SPSS (Statistical Package for the Social Sciences) version 24 Program. Means for the sample sizes and the standard deviations are calculated and these are used as a basis for the comparative analysis. Hypotheses based on Likert-scale questions, ending in interval data, are comparatively analyzed using t-tests and ANOVA.

The Cronbach Alpha coefficients of the construct has the value of 0.780 which indicates the reliability/ high internal consistency of the construct.

4 FINDINGS

The profiles of the students are summarized as follows. Students completed the questionnaire, 46% (n=113) of the whole population were from MTO, 28% (n=68) are from VOT, 26% (n=63) are from ME and 10% (n=28) are missing. With respect to their classes; 156 Freshmen (57%), 14 Sophomores (5%), 37 Junior (14%), and 65 Senior (24 %) students completed the survey. Male students account for 87 % (n=221) and female students account for 13 % (n=34) of the population.

4.1 Descriptive statistics

Frequencies of responses of the whole population on PL are checked as means and standards deviations and the results are given in Table 1. In terms of the frequencies of the responses given to the Likert-type statements, [Ideal leader] Closely monitors the development and progress of his or her employees. ($\mu=4.0956$; $SD= .78622$) emerge as the most important attribute.

The other most important attributes are: Places importance to establishing one-to-one relationship with every employee ($\mu=4.0772$; $SD=.84473$); Asks opinions of employees about work-related issues, however, makes the last decision himself or herself ($\mu= 3.9705$; $SD=.85150$).

On the other hand, [Ideal leader] Does not consider performance as the most important criterion while making a decision about employees (e.g., promotion, layoff) ($\mu=2.5519$; $SD=.98081$); Is prepared to act as a mediator whenever an employee has problem in his or her private life (e.g., marital problems) ($\mu= 2.5993$; $SD=1.07868$) and Places more importance to loyalty than performance in evaluating employees ($\mu=2.6066$; $SD=.96222$) emerge as the least important attributes.

Table 1: Descriptive statistics

| Statements [Ideal Leader...] | N | Mean | Std. Deviation |
|-------------------------------------------------------------------------------------------------------------------------------------------|-----|--------|----------------|
| 1.Behaves like a family member (father/mother or elder brother/sister) towards his/her employees. | 271 | 3.2768 | 1.01150 |
| 2.Provides advice to employees like a senior family member. | 272 | 3.9081 | .88593 |
| 3.Creates a family environment in the workplace. | 272 | 3.6029 | .95105 |
| 4.Feels responsible for employees as if they are his or her own children. | 270 | 3.5000 | .99347 |
| 5.Protects employees from outside criticisms. | 271 | 3.2694 | 1.09093 |
| 6.Places importance to establishing one-to-one relationship with every employee. | 272 | 4.0772 | .84473 |
| 7.Places importance to knowing every employee in person (e.g., personal problems, family life, etc.). | 271 | 3.5941 | 1.01352 |
| 8. Shows emotional reactions, such as joy, sorrow, or anger, in his or her relationships with employees. | 271 | 3.2952 | .93568 |
| 9.Closely monitors the development and progress of his or her employees. | 272 | 4.0956 | .78622 |
| 10.Does not hesitate to take action in the name of his or her employees, whenever necessary. | 272 | 3.9191 | .90554 |
| 11.Is ready to help employees with their nonwork problems (e.g., housing, education of the children, health, etc.) whenever they need it. | 270 | 3.0481 | .97243 |
| 12.Attends special events of employees (e.g., weddings and funeral ceremonies, graduations, etc.) | 272 | 3.0037 | .94692 |
| 13.Is prepared to act as a mediator whenever an employee has problem in his or her private life (e.g., marital problems). | 272 | 2.5993 | 1.07868 |
| 14. Expects loyalty and deference in exchange for his or her care and nurturance. | 272 | 3.2426 | .97569 |
| 15.Does not consider performance as the most important criterion while making a decision about employees (e.g., promotion, layoff). | 270 | 2.5519 | .98081 |
| 16.Places more importance to loyalty than performance in evaluating employees. | 272 | 2.6066 | .96222 |
| 17.Is disciplinarian and at the same time nurturant (tough and tender). | 270 | 3.8926 | .83128 |
| 18.Believes that he or she knows what is best for his or her employees. | 268 | 3.0821 | .92042 |
| 19.Asks opinions of employees about work-related issues, however, makes the last decision himself or herself. | 271 | 3.9705 | .85150 |
| 20.Wants to control or to be informed about every work-related activity. | 272 | 3.2206 | 1.02868 |
| 21.Despite establishing close relationships with employees, keeps his or her distance. | 271 | 3.7491 | .86696 |

4.2 Results of the hypotheses tests

The supported Sub Hypothesis for H₁ regarding the perceptions of students of different majors (MTO, VOT and ME) are summarized in Table 2. Statistically significant differences between three groups are found for three statement after applying ANOVA Test. The supported sub-hypotheses are;

H15 Does not consider performance as the most important criterion while making a decision about employees (e.g., promotion, layoff). ME has the highest mean (2.8095) and MTO has the lowest mean (2.4107) scores.

H16. Places more importance to loyalty than performance in evaluating employees. ME has the highest mean (2.9524) and MTO has the lowest mean (2.4779).

H17. Is disciplinarian and at the same time nurturant (tough and tender). ME has the highest mean (4.1452) and MTO has the lowest mean (3.7946).

Table 2: Comparative results for with respect to majors

| Hypothesis | Support |
|---------------------------------------------------------------------------------------------------------------------------------------|--------------------------|
| H115 Does not consider performance as the most important criterion while making a decision about employees (e.g., promotion, layoff). | supported F=3.437 p=.034 |
| H116 Places more importance to loyalty than performance in evaluating employees. | supported F=6.070 p=.003 |
| H117 Is disciplinarian and at the same time nurturant (tough and tender). | supported F=3.780 p=.024 |

Method of analysis is ANOVA, $p < 0.05$

The second hypotheses of the conceptual model attempts to compare perceptions of the students regarding PL with respect to their classes. ANOVA test was used in order to test the sub-hypotheses. One statement has statistically significant differences (See Table 3). The statement that is perceived different by the sample is given below:

H216 Places more importance to loyalty than performance in evaluating employees. Sophomores (2.9286) and Freshmen (2.8077) have the higher mean scores than Juniors (2.1892) and Seniors (2.2923).

Table 3: Comparative results for with respect to classes

| Hypothesis | Support |
|----------------------------------------------------------------------------------|--------------------------|
| H216 Places more importance to loyalty than performance in evaluating employees. | Supported F=8.002 p=,000 |

Method of analysis is ANOVA, $p < 0.05$

Results of the tests for H₃ regarding the perceptions of students of different genders are summarized in Table 4. Statistically significant differences between two groups are found for two statements after applying t-test. The supported sub-hypotheses are:

H37 Places importance to knowing every employee in person (e.g., personal problems, family life, etc.). Male students have the higher mean scores (3.6273) than female students (3.2353) for this statement.

H321 Despite establishing close relationships with employees, keeps his or her distance. Female students have the higher mean scores (4.0588) than male students (3.7059) for this statement.

Table 4: Comparative results for with respect to gender

| Hypotheses | Support | |
|---------------------------------------------------------------------------------------------------------|---------------------------------|-----------------|
| | t | Sig. (2-tailed) |
| H37 Places importance to knowing every employee in person (e.g., personal problems, family life, etc.). | Supported t= -2.129 9 p=.034 | .034 |
| H321 Despite establishing close relationships with employees, keeps his or her distance. | Supported t= 2.654 p=.011 | .011 |

Method of analysis is t-test, $p < 0.05$

5 CONCLUSION

The main conclusion of this study despite the fact that USA workplace is ranked low on power distance values [16], paternalistic leadership can be accepted as a viable leadership style among maritime students of distinctive maritime work environment. The results of the study reveal that according to maritime students, ideal leader places importance to establishing one-to-one relationship with every employee, closely monitors the development and progress of his or her employees and also asks opinions of employees about work-related issues, however, makes the last decision himself or herself. Statistically significant differences were found in the statements between the three groups surveyed. Three found in the statements among Majors, one statement among Class, and two statements among Gender.

As a future study a cross cultural study will be performed to determine the acceptance of PL in international maritime work domain.

REFERENCES

- [1] NTSB. National Transportation Safety Board. Cosco Busan Allision with San Francisco-Oakland Bay Bridge.305-331 / NTSB/MAR-09/01,2009
- [2] Chen, X. and others. Affective trust in Chinese leaders: linking paternalistic leadership to employee performance. In: *Journal of Management*, Vol. 40 No. 3, March 2014 796–819, DOI: 10.1177/0149206311410604
- [3] Pellegrini, E. K. and others. Paternalistic Leadership: A Review and Agenda for Future Research. In: *Journal of Management*. Vol.34. 2008. pp. 566-593.
- [4] Aycan, Z. Paternalism: Towards conceptual refinement and operationalization, In K. S. Yang, K. K. Hwang, & U. Kim (Eds.), *Indigenous and cultural psychology: understanding people in context*. New York, NY: Springer. pp. 445–466, 2006

- [5] Mansur, J. and others. Shades of paternalistic leadership across cultures. In: *Journal of World Business*. 2017. [viewed date 5. May 2017] Available from <<http://dx.doi.org/10.1016/j.jwb.2017.06.003>>
- [6] Jackson, T. Paternalistic leadership: The missing link in cross-cultural leadership studies. In: *International Journal of Cross Cultural Management*. 2016, Vol. 16(1) 3–7.
- [7] Westwood, R. and others. Headship and leadership, in R. Westwood (Ed.), *Organizational behaviour: Southeast Asian perspectives*. Hong Kong: Longman. pp.118-143. 1992
- [8] Farh, J. L. and others. A cultural analysis of paternalistic leadership in Chinese organizations. In Li., J. T. and others (Eds.). *Management and organizations in the Chinese context*. London: Macmillan. pp. 84-127, 2000.
- [9] Hsieh, K.C. and others. Development and significance of paternalistic leadership behavior scale. In: *Asian Social Science* Vol. 7, No. 2; February. 2011 pp.45-55.
- [10] Bor-Shiuan, L. and others. Paternalistic leadership and subordinate responses: establishing a leadership model in Chinese organizations. In: *Asian Journal of Social Psychology*. Vol. 7. 2004. pp. 89–117.
- [11] Aycan, Z. Impact of culture on human resources management practices: A 10 country comparison. In: *Applied Psychology: An International Review*. 49 (1). 2000. pp.192-221.
- [12] Pellegrini, E. K., and others. Cross-cultural generalizability of paternalistic leadership: an expansion of leader-member exchange theory. In: *Group & Organization Management*. Vol. 35. 2010. pp. 391-420.
- [13] Aycan, Z, and others. Career choices, job selection criteria, and leadership preferences in a transitional nation: The case of Turkey. In: *Journal of Career Development*, Vol. 30, No. 2, 2003
- [14] Erben, G. S. and others. The Relationship between paternalistic leadership and organizational commitment: investigating the role of climate regarding ethics. In: *Journal of Business Ethics*. 2008. 82:955–968.
- [15] Asyali, E. and others. Paternalistic leadership: a preliminary study on Maritime Students. Maritime Education Summit, Maine Maritime Academy, USA, September, 17 – 19, 2014
- [16] GLOBE study. Cultural practices and values in USA. [viewed date 13 June 2018]. Available from: <<http://www.globeproject.com /results/ countries/ USA? Menú =list>>

RETHINKING STCW EDUCATION TO COPE WITH INCREASED AUTONOMY AND AUTONOMOUS SHIPPING

JOHN MOGENSEN *

* Svendborg International Maritime Academy (SIMAC)
Graaesvej 27, DK-5700 Svendborg, Denmark
e-mail: jmo@simac.dk, <http://www.simac.dk>

Keywords: STCW, Autonomous, Education, Control Systems.

Abstract. This paper presents the results of an observational study on education within Marine Cybernetics, carried out at Norwegian University of Science and Technology, (NTNU), Trondheim Norway, in the spring 2018. The observational environment chosen at NTNU is within education for the design of Marine Cybernetics. With growing autonomy and automation within the shipping industry, understanding the design principles can become even more important for a ship's crew than it is already today. The vital components of the education for design of control systems is identified and analyzed for comparison with an education for STCW compliance. Based on this a number of recommendations have been drawn up for coping with increased autonomy and automation in shipping in STCW education.

1 INTRODUCTION

The increasing complexity of systems onboard ships and within systems, which the students at maritime academies are educated in, with a view to operating and maintaining them, requires a somewhat different kind of approach for teaching system interrelations and system governance. This is considered traditionally necessary for marine engineers in automation, and for master mariners partly in navigation and partly in ships technology. The path towards autonomy in the overall governance of the system especially calls for an analysis of the implied competencies that are to be expected by the operators and maintenance engineers, and a comparative analysis with an up to date teaching strategy in order to generate valid advice on how the teaching strategy of tomorrow should be structured in order to cope with the challenges. In order to obtain knowledge of the implied competencies, the teaching environment for the designers of these systems is thought to be a valuable source for predicting design strategies for future systems. For marine systems, one of the world's top most leading universities within system interrelations and system governance is the Norwegian University of Science and Technology (NTNU), where this area of research has been given the overall framework of cybernetics. This paper presents an analysis of the

teaching environment in marine cybernetics at NTNU and performs a comparative analysis of the perceived teaching competencies in relation to the Svendborg International Maritime Academy, (SIMAC). SIMAC educates marine engineers and master mariners according to the STCW convention and Danish legislation. Based on that analysis of differences, valid advice is generated for future a teaching strategy in system interrelations and system governance for the different studies at SIMAC. The methodology involves observations of lectures and group work, interviews with identified key persons, interaction with the study environment and meta-cognitive analysis of course evaluations.

2 GENERAL DIFFERENCES BETWEEN UNIVERSITIES AND MARITIME ACADEMIES

The general differences between university education and STCW training at maritime academies can be summed up as consisting of the different emphases laid down on mastering general competencies within mathematics, physics and chemistry. Where the universities put much effort into raising the students' general competencies to a very high level before venturing into more specialised knowledge areas, the general approach in STCW training and the overall approach at SIMAC is to teach general competencies alongside specialised knowledge. Many pros and cons can be raised for both approaches. One of the main advantages of the university approach is the students' ability to use linear algebra and especially the matrix calculus. This gives the university students' an ability to generate highly reliable lumped sum mathematical models within a wide variety of scientific fields, including the technical areas covered by the STCW training. Within STCW training, the student is also educated to use mathematics in modelling physical systems but seldom in the framework of matrix calculus. University education within the field of engineering is mainly focused on the design aspects of systems and structures, whereas STCW education is mainly focused on operation and maintenance. This difference in focus calls for some differences in teaching approaches and also for differences in study programs: a university education in engineering leads to a highly specialised focus area within just one of the many fields of expertise that a master mariner and a marine engineer has to cope with in every day operations on board a ship. Presently, this leads to a structure in STCW education in which master mariners and marine engineers are taught subjects equivalent to fields of engineering in ships design, mechanical structures, production engineering, energy systems, environmental systems, electrical designs, electronics, computer science and earth science. Obviously, a master mariner or marine engineer cannot reach the same level of expertise in each of these areas as a university educated engineer, simply due to time constraints on the length of education. A university education to master's level takes, in general, 5 years. That is equivalent to the length of the study programs in Denmark for master mariners and marine engineers. To sum up: the SCTW education should lead to generalist competencies in ship engineering with a focus on operation and maintenance of all structures and shipboard systems.

2.1 Structure in education at NTNU

At NTNU the first 3 years of study revolves around general subjects within physics,

chemistry, mathematics and engineering. Some introduction is also given to more specific fields of application. For a student of maritime engineering this includes courses in hydrodynamics and ship technology. One of the study lines is specialized in Marine Cybernetics. For these students there is also a mandatory course on linear control theory included in the first 3 years. After the first 3 years, the students transfer into specialized courses. There are a number of courses in Marine Cybernetics in the last 2 years of study. First an introduction course on marine control systems dealing with linear control theory in marine applications, a course on control and architecture of electrical power plants, a course in non-linear control theory and marine applications, a course on guidance, navigation and control, an “Expert in Teams” course, where teams are formed across study lines to elaborate and design ideas, a 15 ECTS specialization project, where the student gets the chance to deep-dive into a field of interest and finally a 30 ECTS master project, where the student can expand the knowledge and field of interest. Throughout the study program, the students collaborate across fields of specializations and on several occasions, there are organized competitions between cross-disciplinary teams, which is perceived among the students to be highly motivating.

2.2 Structure in education at SIMAC

At SIMAC the first 3 semesters are used for gaining vocational training and practices within the fields of mechanics, electrics and seamanship. The actual contents and length of the training and practice varies for the three study lines taught at SIMAC. Common for all of the study lines is, that it is vocational training and very little use of mathematical, physical and chemistry theory is included in the education at this point. After the first three semesters, the students have introductory courses on applied science within their study lines. These courses use mathematics, physics and chemistry on a varying level of difficulty, ranging from expert level to introductory level. Common in the approach and setting of teaching level is the requirement for operation and maintenance of the available systems on board ships. For control systems, the teaching is diversified and a common level is not reached among the study lines. For the marine engineers a rather deep level is reached within control systems architecture, control strategies and linear single-input-single-output (SISO) control theory, but they have no teaching of multi-input-multi-output (MIMO) systems, non-linear control theory or even the systems architecture around modern navigational systems. For the master mariner a rather deep level is reached within control theory directly related to the control of the ships path, but only a superficial introduction is given to systems architecture and control theory in general. They are to a large extent educated to be the system governor of the ship control systems. In automated ship control systems, the system governor is automatic.

2.3 Gap Analysis between NTNU and SIMAC

The most predominant gap between the education for design at NTNU and the education for operation and maintenance at SIMAC is the difference in mathematical levels. Looking deeper into this difference and the perceived need for operation and maintenance of marine control systems shows the gap to consist of the different levels in the understanding of matrix calculus. The only other significant gap identified is the teaching of systems architecture of

navigational systems, but this teaching does not need to make use of extensive mathematical formulations.

3 HOW TO STRUCTURE EDUCATION IN MARINE CONTROL SYSTEMS FOR STCW PURPOSE

It was found through the comparative gap analysis in section 2, that matrix calculus yields an important fundamental knowledge level for the understanding and design of control systems. The application of mathematical modelling and simulation software expands these competencies further and access to physical systems for experiments and analysis makes it possible to reach a specialist level for systems design. Taking this level for the designers of autonomous and automated systems and transferring it to STCW education is not straightforward though. The students will for the most part lack the needed mathematical skills, but that can be coped with to a certain degree by increasing the emphasis laid down on mastering matrix calculus in the teaching.

3.1 Matrix Calculus versus other approaches in multivariate calculus

In the real world, physical properties very seldom depend on only one variable. As a seafarer, one has very often to consider a variety of variables that all influence the system under consideration, whether it is the operation of the main engine, the travelling path of the vessel or the loading condition of the hull. All of these areas are increasingly modelled and supervised by autonomous systems [1], which, in their essence, are designed with the use of multivariate calculus. In general, multivariate calculus can be thought of as a system of interrelated variables for which, equations can be formulated. Solving these equations simultaneously yields the state of the system. One way of writing this is given in equation 1 for three independent variables, $\{x, y, z\}$, where $\{a, b, c, d\}$ represent arbitrary known constants.

$$ax = b ; y = cx ; z = dx \quad (1)$$

Solving this equation in a recursive manner for each variable is a straightforward task, which should be manageable by any high school graduate and quite similar to the way STCW training handles mathematical descriptions of physical systems. Writing the same equation in a matrix calculus format as given in equation 2 may seem at first glance to be making the problem more cumbersome.

$$[x,y,z]^T = [b/a,0,0;0,cb/a,0;0,0,db/a][1,1,1]^T \quad (2)$$

However, this framework of writing the mathematical formulation of the physical system yields a tremendous simplification of systems with multiple variables and complex dependencies, which can be solved by using mathematical software. Even more importantly, the majority of all discrete control systems in the marine environment are written by use of matrix calculus.

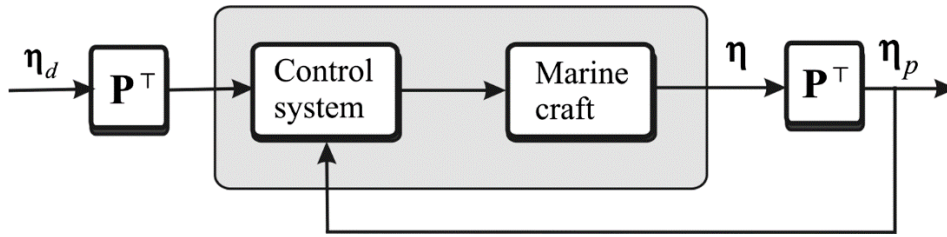

Figure 1: Transformation of desired position and measured position in a feedback control system using vessel parallel coordinates, [3].

An example of a modelled control system for a ship in transit between two desired positions is shown in figure 1, [3]. The desired position matrix, η_d is given as input to a transformation matrix \mathbf{P} , changing the coordinate system of reference before being used in the control system. The measured position matrix, η is also transformed by the transformation matrix, \mathbf{P} , to the feedback signal, η_p , before being fed to the control system. The control system calculates the needed corrections based on the comparison of the transposed η_d and η_p and send these corrections to the actuators of the ship. The actuators can be rudders, propellers, thrusters, stabilizing fins, ballast systems etc. basically anything that can control the ships position and motion in the 6 degrees of freedom as visualized by figure 2, [3].

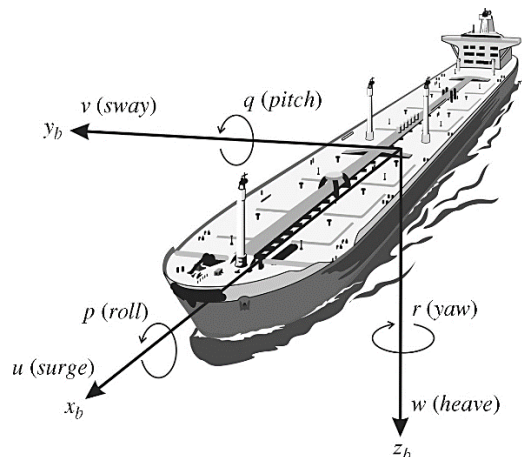

Figure 2: Definitions of the 6 degrees of freedom of movement on a marine vessel, [3].

For non-autonomous systems, the actuators are split into separated control systems and the physical interaction between them has to be understood by the operator and maintenance engineer, who makes changes into the systems. In autonomous systems and semi-autonomous systems like dynamical positioning systems, the actuators are coupled together in one control system, which makes the demand for understanding the physical properties and underlying systems architecture of the control system even more important for the operators and maintenance engineers.

An important feature of multivariate calculus is the stability in the system of equations and thereby the stability in the physical system that the system of equations models. Often in

control systems, this stability is ensured by choice of suitable constants for the equations [2]. Often these constants are laid out for the operator to adjust during operation, similar to the settings in the autopilot. Very often the systems is designed in a way, where choices can be made of variables that makes the system unstable, which ultimately can result in total failure of the system. Thus, in order to activate the understanding and competent interaction with control systems a good command is needed of matrix calculus and a general understanding of the design structure of control systems for all operators and especially for maintenance engineers.

4 DISCUSSION

Taking the command of matrix calculus as a prerequisite for teaching in control systems enables a number of interactive ways for structuring the learning process. It makes it possible for the students to build their own control systems, operate ready-built models and gain valuable insights in the design structure of control systems by a comprehensive and meta-cognitive learning process, where the individual student gains the competence to analyze any system based on its appearance and responses to interaction. In STCW education this is not an option due to time constraints and the limited number of subjects that can benefit from the use of matrix calculus. It is however needed in order to understand the systems architecture of discrete control systems, so there should be some form of inclusion of matrix calculus. As for physical systems interaction, it is not so important exactly how the physical system is structured as long as it gives a reliable representation for the subject matter, e.g. a small ship model can easily give the sufficient learning of the physical system interaction in order to design, operate and analyze ship motion control. At NTNU the majority of learning is accomplished using simulators and only a very limited use of model-scale ships is utilized. In STCW education a lot of practice is included on full-scale operating ships, which could include more learning objectives of control systems in order to reach the needed level of expertise.

The STCW education of today, as it is structured at SIMAC, is in many ways teaching the students to operate in teams, but only rarely in cross-disciplinary teams, which could be a huge beneficial learning method.

5 CONCLUSION

Based on the study it can be concluded that, in order to cope with increased autonomy and autonomous shipping, the teaching of matrix calculus should be included in STCW education at introduction level for both master mariners and marine engineers. It was also found that utilizing cross-disciplinary teams can lead to a huge beneficial learning environment, especially when combined with competitions.

6 RECOMMENDATIONS

Based on these conclusions, it is recommended that the teaching of matrix calculus be included in the master mariner and marine engineer study program. It is recommended that this teaching subject is taught together with an introduction to ship control systems architecture and the control theory related to navigation and ship guidance. It is highly recommended that this teaching should be undertaken with a structure that allows the

interaction of master mariners and marine engineers. It is recommended that this is a one-semester course situated towards the end of the study programs for master mariners and marine engineers and with an approximate size of 5 ECTS points. Within the course work, there should be included hands-on work by the students on navigational and control systems, in either hardware or a simulated environment. To increase motivation and strengthen the cross-disciplinary teamwork, the course could beneficially include a competition among the teams and perhaps against other STCW institutions.

REFERENCES

- [1] Sørensen, A. J., Marine Control Systems, Propulsion and Motion Control of Ships and Ocean Structures, 3rd Edition. akademika forlag, 2013.
- [2] Khalil, H. K., Nonlinear Systems, 3rd Edition. Pearson, 2002.
- [3] Fossen, T. I., Handbook of Marine Craft Hydrodynamics and Motion Control, John Wiley & Sons, Ltd, 2011

ROLE OF ECDIS TRAINING ON IMPROVING SITUATIONAL AWARENESS

STEPHEN J. COLE^{*}, ENDER ASYALI[†]

^{*} Department of Marine Transportation
Maine Maritime Academy
1 Pleasant St., Castine, ME, 04420 USA
e-mail: stephen.cole@mma.edu, <https://www.mma.edu>

[†] Department of Marine Transportation
Maine Maritime Academy
1 Pleasant St., Castine, ME, 04420 USA
e-mail: ender.asyali@mma.edu, <https://www.mma.edu>

Keywords: ECDIS training, situational awareness, voyage planning

1 INTRODUCTION

August of 2018 marks the completion of the phasing in of ECDIS carriage requirements on SOLAS vessels engaged in international voyages. Additionally, more and more flag states are implementing similar ECDIS and/or ECS carriage requirements for vessels engaged in domestic trade within their territorial waters. Mariners are required to receive training in accordance with IMO Model Course 1.27 “Operational use of Electronic Chart Display and Information Systems” to serve as the Officer in Charge of the Navigation Watch (OICNW) on ECDIS equipped SOLAS vessels and some countries look for this same level of training to serve on their domestic fleet’s vessels if they’re equipped with either ECDIS or ECS. This is understandable considering the complexity of these navigation systems, yet even with this training requirement marine incident investigation organizations are still identifying improper use of ECDIS as a causal factor in groundings, which implies that rather than improving situational awareness these systems, at least in some cases, enable complacency (1; 2; 3; 4; 5). This paper describes the authors’ efforts to gauge the effectiveness of ECDIS training through a statistical analysis of surveys completed by students before and after formal generic ECDIS training. The surveys are designed to measure the attitudes of the students towards the value of ECDIS in maintaining situational awareness and improving safety of navigation.

ECDIS is not only an e-navigation tool which can be used to satisfy the nautical chart carriage requirement of SOLAS, but can also totally change the way/method of performing marine navigation (6). ECDIS will be the focal point and main hub for Integrated Bridge Systems when configured as a Multifunction Display device where all voyage related data and

information from multiple sources such as propulsion, navigation control systems, steering systems, alarms, etc. can be accessed and used as a “decision support system” for both routine and emergency situations. (7)

1.1 Voyage planning

According to the IMO Guidelines for Voyage Planning (8), “The development of a plan for voyage or passage, as well as the close and continuous monitoring of the vessel's progress and position during the execution of such a plan, are of essential importance for safety of life at sea, safety and efficiency of navigation and protection of the marine environment.”

“Voyage and passage planning includes appraisal, i.e. gathering all information relevant to the contemplated voyage or passage; detailed planning of the whole voyage or passage from berth to berth, including those areas necessitating the presence of a pilot; execution of the plan; and the monitoring of the progress of the vessel in the implementation of the plan.” In this paper these four stages of voyage planning are collectively referred to as voyage planning dimensions.

Clearly safety of navigation is fundamentally dependent upon the careful creation and verification of a detailed voyage plan. It follows that for the Officer In Charge of the Navigation Watch (OICNW) to navigate safely a thorough knowledge of the voyage plan is required, along with the ability to accurately interpret all aspects of the plan as displayed on the ECDIS.

1.2 Situational awareness

According to Endsley (9), Situational Awareness (SA) is “the perception of the elements in the environment within a volume of time and space, the comprehension of their meaning, and the projection of their status in the near future”. SA is comprised of three dimensions: *Perception* - perceiving critical factors in the environment; *Comprehension* - understanding what those factors signify; and *Projection* - anticipating what will happen, or how the situation will evolve, in the near future. These levels are cumulative in nature as projection cannot occur without comprehension and comprehension cannot occur without perception.

Marine incident investigation reports reveal that loss of SA is directly responsible for 27 percent of marine incidents (10). ECDIS can play an important role for developing and maintaining a high level of situational awareness by supporting the four dimensions of voyage planning: appraisal, planning, execution and monitoring.

1.3 Relationship between cognitive hierarchy and situational awareness (SA)

For understanding SA, the difference between the terms data, information, knowledge and understanding has to be defined. According to International Association for Information and Data Quality (11), data is the raw material from which information is produced when it is put in a context that gives it meaning. Information is data in context, i.e., the meaning given to data or the interpretation of data based on its context; information is the data that have been shaped into a form that is meaningful and useful to human beings; knowledge is the understanding of the significance of information or information that is actionable. Knowledge contributes to understanding when experience, expertise and intuition are applied; a Cognitive Hierarchy Diagram can be used to describe this relationship (12), see Figure 1.

Endsley and Jones (13) suggest that the way in which information is presented by such systems influences SA by determining how much information can be acquired, how accurately

it can be interpreted and to what degree it is compatible with SA needs. Endsley and Jones draw a parallel between Endsley's three levels of SA and the “cognitive hierarchy” of data, information, knowledge, and understanding. Data correlated becomes information. Information converted into situational awareness becomes knowledge. Knowledge used to predict the consequences of actions leads to understanding. Endsley and Jones suggest that “knowledge” in this description equates to level 1 (Perception) SA and “understanding” equates to levels 2 (Comprehension) and 3 (Projection) SA. A higher level of SA requires relevant, accurate, and timely data and information which can be transformed into knowledge and understanding.

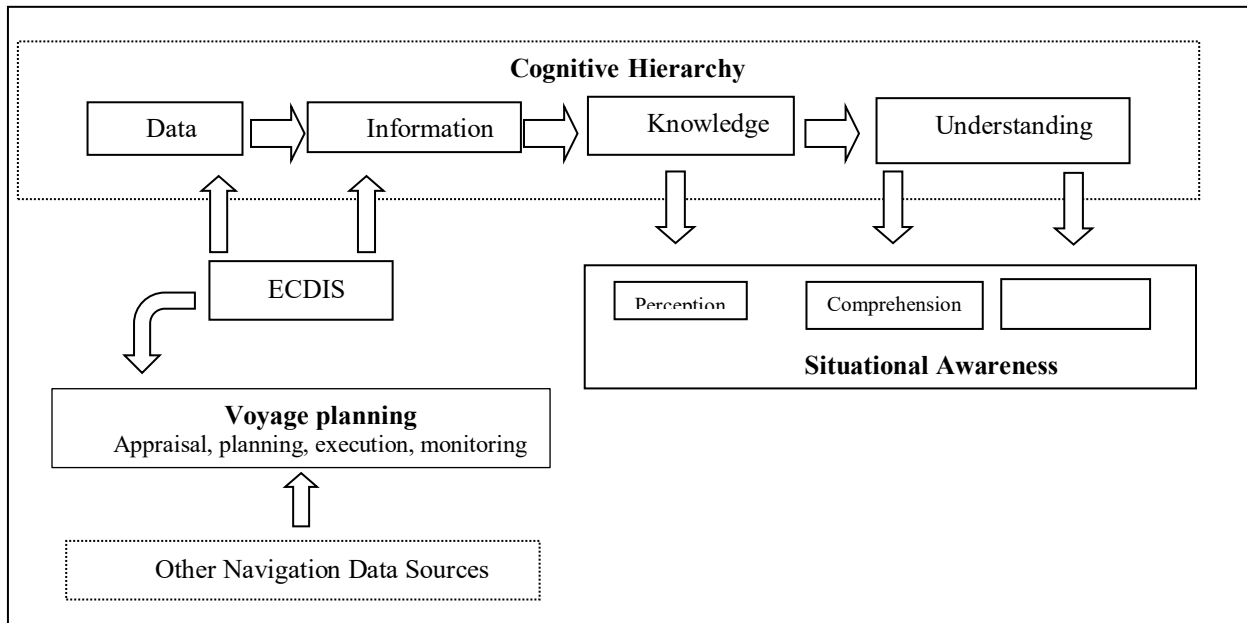

Figure 1: Cognitive hierarchy showing relationship between ECDIS and VP and SA
Source: Authors, developed from (6)

2 RESEARCH DESIGN AND METHODOLOGY

2.1 Objectives of the study

The objectives of the work upon which this paper is based is to determine the attitudes of ECDIS trainees towards the effectiveness of the system to increase situational awareness during voyage execution and monitoring and also in creating detailed and safe voyage plans. To gauge the soundness of the training a survey is given at the beginning of the training period and again at the end of the training period. A statistical comparison of the two surveys enables a subjective determination of whether the provided training is indeed having the desired effect, acceptance of the tenants of ECDIS best practices as being invaluable to increasing the OICNW’s awareness of stationary and moving hazards to navigation that may threaten safe navigation.

2.2 Data collection and sampling

The research covers descriptive statistics, comparative analysis and correlation tests between the dimensions of SA and VP. Data processing is maintained by the SPSS 24 (Statistical Package for the Social Sciences) Program. Hypotheses tests (t-test) were conducted in order to find the significant differences before and after the training period. Correlation tests were conducted to find the relations between voyage planning and situational awareness dimensions.

To test the hypothesis of the research, a survey made up of three parts was developed. Statements concerning the objectives of the study were designed to ascertain the attitudes of trainees towards ECDIS and to explore the relationships between ECDIS, SA, and VP as perceived by the trainees.

The first part of the survey consists of three statements addressing the relationship between ECDIS and the three dimensions of SA (perception, comprehension, and projection). The second part contains three statements addressing the relationship between ECDIS with radar overlay and the three dimensions of SA. The third and final part of the survey is made up of four statements addressing the relationship between ECDIS and the four dimensions VP (appraisal, planning, execution, and monitoring).

A 5-point “Likert Scale” with anchors at 1 (very low) and 5 (very high) was used to assign a value to each survey statement response and enable a statistical analysis. There was one demographic question included to determine each trainees’ major program of study.

The surveys were administered to Maine Maritime Academy cadets enrolled in E-Nav II, the Academy’s course that focuses primarily on ECDIS training, during the Spring 2017, Fall 2017, and Spring 2018 semesters. Identical surveys were conducted at both the commencement and completion of each semester. For comparative analysis, forty-eight pre-course surveys and fifty-one post-course surveys, for a total of ninety-nine surveys, were collected from the same sample group. For descriptive statistics and correlation analysis, the post-course surveys only were used.

3 FINDINGS

3.1 Descriptive statistics

Overall mean scores and standard deviations are listed in Table 1. The statements on the surveys, column one of Table 1, completed by the trainees were preceded by “The impact of ...”, for example, statement one reads, in full, “The impact of ECDIS on improving perception.” The possible responses are: 1-Very Low, 2-Low, 3-Adequate, 4-High, and 5-Very High.

3.1.1 Perception of students concerning relationship between ECDIS and situational awareness dimensions

In the first part of the questionnaire, the impact of ECDIS on increasing *Perception* (What is happening?) ($\mu = 4.4902$) was found to have the highest mean score, 55% (n:28) of respondents indicating that the impact of ECDIS on increasing perception is very high. “The impact of ECDIS on *Projection*” (What will happen next?) ($\mu = 4.3725$) has a higher mean score than “Impact of ECDIS on *Comprehension*” (What does it mean?) ($\mu = 4.3333$). This result

indicates that ECDIS has more impact on improving *Perception* and *Projection* than *Comprehension*.

Accurate comprehension requires an adequate amount of pre-existing skill, knowledge and experience, traits that the navigator must possess and that ECDIS cannot provide on its own. ECDIS is better at answering the questions “What is happening?” and “What will happen next?”. ECDIS by itself provides limited support in answering the question “What does it mean?”, which relies upon the navigator’s personal judgement to be answered accurately.

Table 1: Descriptive statistics

| Statements | N | Minimum | Maximum | Mean | Std. Deviation |
|--------------------------------|----|---------|---------|--------|----------------|
| ECDIS Perception | 51 | 3.00 | 5.00 | 4.4902 | .61229 |
| ECDIS Comprehension | 51 | 3.00 | 5.00 | 4.3333 | .62183 |
| ECDIS Projection | 51 | 3.00 | 5.00 | 4.3725 | .59869 |
| ECDIS with RADAR Perception | 51 | 1.00 | 5.00 | 4.2745 | .87358 |
| ECDIS with RADAR Comprehension | 51 | 2.00 | 5.00 | 4.0980 | .85452 |
| ECDIS and RADAR Projection | 50 | 1.00 | 5.00 | 4.0200 | .89191 |
| ECDIS Appraisal | 51 | 2.00 | 5.00 | 4.2745 | .77662 |
| ECDIS Planning | 51 | 4.00 | 5.00 | 4.7059 | .46018 |
| ECDIS Execution | 51 | 3.00 | 5.00 | 4.5294 | .61165 |
| ECDIS Monitoring | 51 | 3.00 | 5.00 | 4.6275 | .56430 |

3.1.2 Perception of students concerning relationship between ECDIS with radar overlay and situational awareness dimensions

According to IMO ECDIS Performance Standards (14), an ECDIS display may be used for the display of radar and/or radar tracked targets and it should be possible to remove the radar information by single operator action

Mean scores for statements related to SA and ECDIS with radar overlay are found to have less than mean scores with the statements ECDIS without radar overlay. This indicates that more information, like radar overlay, does not improve SA. Having more data on the screen has negative impact on SA.

Acquiring needed information and the method of presenting, or displaying, that information to the navigator has a great deal of influence on that navigator’s SA. Both a lack of needed information and too much information can negatively impact SA. (15)

3.1.3 Perception of students concerning the relationship between ECDIS and voyage planning dimensions

In the third part of the questionnaire, the statement “The impact of ECDIS on planning” ($\mu=4.7059$) is found to have the highest mean score, 70% (n: 36) of the respondents believe that the impact of ECDIS on voyage planning is very high. The other two statements having high scores are; “The impact of ECDIS on monitoring” ($\mu=4.6275$) and “The impact of ECDIS on

execution” ($\mu=4.5294$). “The impact of ECDIS on Appraisal” ($\mu=4.2745$) received the lowest mean scores.

ECDIS provides limited support to navigators during the appraisal phase of voyage planning. Navigators require more information than ECDIS alone can supply in order to create a safe and efficient voyage plan such as: the condition and state of the vessel, its stability, and its equipment; any operational limitations; its permissible draught at sea, in fairways, and in pilotage areas; its maneuvering data, including any restrictions; characteristics of the cargo; existing radio navigational warnings; and other resources including but not limited to sailing directions, lists of lights and lists of radio aids to navigation, and mariners' routing guides.

3.2 Hypotheses test

In addition to the descriptive statistics, hypotheses tests (t-test) were conducted in order to find the significant differences before and after training, see Table 2, H₁, H₂, and H₃. Finally, the correlations between the voyage planning dimensions and SA dimensions were tested, H₄.

Four hypotheses were developed to test the study’s objectives:

- H₁: Perception of students concerning relationship between ECDIS and Situational Awareness differs before and after training.
- H₂: Perception of students concerning relationship between ECDIS with radar overlay and Situational Awareness differs before and after training.
- H₃: Perception of students concerning relationship between ECDIS and Voyage Planning differs before and after training.
- H₄: Voyage planning dimensions are related with situational awareness dimensions

Table 2: Hypotheses test results

| Hypotheses | Support | |
|------------------------------------------------------------------------------------------|---------------------------------------|--------------------|
| | T | Sig. (2 tailed) |
| H ₁ : Relationship between ECDIS and Situational Awareness | supported t= -5.039, p>0,05 | .000 |
| H ₂ : relationship between ECDIS with radar overlay and Situational Awareness | supported t= -2.158 p>0,05 | .033 |
| H ₃ : relationship between ECDIS and Voyage Planning | supported t= -5.772 p>0,05 | .000 |

The t-test results show the significant differences of the students’ perceptions towards ECDIS before training compared to after completing training. These results demonstrate the positive impact of training on this group of students.

3.2.1 Testing hypothesis 4, Voyage planning dimensions are related with situational awareness dimensions

Correlations between voyage planning and SA dimensions were tested. The results for H₄ are given in Table 3, which presents the correlation coefficients of the variables in the study. The data indicates strong positive correlations between: ECDIS Perception and ECDIS Appraisal ($r=.637$, $p<0.01$); ECDIS Planning ($r=.451$, $p<0.01$); ECDIS Execution ($r=.468$, $p<0.01$), and ECDIS Monitoring ($r=.423$, $p<0.01$). Also there is a strong positive correlation between ECDIS Comprehension and ECDIS Appraisal ($r=.469$, $p<0.01$). The data indicates weak correlations between ECDIS Projection and ECDIS Monitoring ($r=.182$, $p<0.01$).

In summary, VP with ECDIS effects SA in a positive way. When we consider the VP dimensions (appraisal, planning, execution and monitoring), perception is correlated strongly with all dimensions of voyage planning. ECDIS derived information increases the navigator's perception, enabling more comprehensive VP. The graphical display of the VP on ECDIS simplifies the execution and monitoring of the VP. But VP only affects comprehension at a moderate level because comprehension requires basic knowledge and experience. VP by itself is not be enough to increase comprehension. Lastly we note that projection is weakly correlated with all four VP dimensions.

Table 3: Correlation matrix: Impact of ECDIS on VP and SA dimensions

| | ECDIS Appraisal | ECDIS Planning | ECDIS Execution | ECDIS Monitoring |
|---------------------|--------------------|-------------------|--------------------|---------------------|
| ECDIS Perception | 0.637** | 0.451** | 0.468** | 0.423** |
| ECDIS Comprehension | 0.469** | 0.280 | 0.316* | 0.247 |
| ECDIS Projection | 0.335* | 0.260 | 0.324* | 0.182 |

** Significant correlation at the 0.01 level (2-tailed) Pearson Correlation

* Significant correlation at the 0.05 level (2-tailed) Pearson Correlation

4 CONCLUSIONS

The survey data collected from the students indicates that ECDIS increases the navigator's overall SA and improves VP. The results also indicate that the addition of a radar overlay on the ECDIS display decreases SA, possibly due to information overload and/or a lack of watch standing experience. The collection of survey data prior to and after training clearly shows an improvement in the students' appreciation of ECDIS capabilities. Lastly we note that SA and VP are strongly correlated and that VP improves perception, enabling an ECDIS navigator to more easily determine "What is happening?".

4.1 Limitations and further study

This study is based on data gathered at only one institution and the respondents' experience with fully implemented ECDIS was limited. For further study the attitudes of mariners having more experience with fully implemented ECDIS can be examined.

REFERENCES

- [1] Marine Accident Investigation Branch. *Report on the investigation of the grounding of Muros, Haisborough Sand, North Sea*. Southampton : Crown copyright, 2017. Report No. 22/2017.
- [2] —. *Grounding of CSL Thames in the sound of Mull*. Southampton : Crown Copyright, 2011. Report No. 2/2012.
- [3] —. *Report on the investigation of the grounding of Maersk Kendal on Monggok Sebarok reef in the Singapore Strait*. Southampton : Crown copyright, 2010. Report No. 2/2010.
- [4] —. *Report on the investigation of the grounding of Ovit in the Dover Strait*. Southampton : Crown copyright, 2017. Report No. 24/2014.
- [5] —. *Report on the investigation of the grounding of the CFL Performer, Haisborough Sand, North Sea*. Southampton : Crown copyright, 2008. Report No. 21/2008.
- [6] Asyali, E., The role of ECDIS on improving situational awareness. St. Johns, Newfoundland : In: *Proceedings 13th Annual General Assembly of the IAMU 2012*. pp. 123-136. ISBN: 978-0088901-439-9.
- [7] IMO MSC. Adoption of new and amended performance standards for integrated bridge systems. *Index of IMO resolutions*. [Online] 1996. [Cited: May 15, 2018.] [http://www.imo.org/en/KnowledgeCentre/IndexofIMOResolutions/Maritime-Safety-Committee-\(MSC\)/Documents/MSC.64\(67\).pdf](http://www.imo.org/en/KnowledgeCentre/IndexofIMOResolutions/Maritime-Safety-Committee-(MSC)/Documents/MSC.64(67).pdf).
- [8] IMO Guidelines for Voyage Planning. *Guidelines for Voyage Planning Resolution A.893(21)*. 1999.
- [9] Endsley, M. R. Toward a theory of situation awareness. In: *Human Factors*, 1995, Vol. 37. Pages 32-64.
- [10] Baker, C. C., et al, *Maritime accidents and human performance: the statistical trail*. Singapore : ABS Technical Papers, 2004.
- [11] International Association for Information and Data Quality. IQ/DQ Glossary. [Online] April 25, 2012. [Cited: May 23, 2018.] <http://www.iaidq.org/main/glossary.shtml>.
- [12] Laudon, K. C. et al, *Management information systems, managing the digital firm*. New York : Pearson, 2014. ISBN-13 97801330500691.
- [13] Endsley, M. R. et al, *Situation awareness, information dominance and information warfare*. Belmont, MA : Endsley Consulting, 1997. ISBN: 19980623-081.
- [14] IMO MSC. Adoption of the revised performance standards for electronic chart display and information systems (ECDIS) MSC.232(82). *Index of IMO Resolutions*. [Online] December 5, 2006. [Cited: May 30, 2018.]
- [15] Endsley, M. R., Situation Awareness in Aviation Systems [book auth.] D. J. Garland, J. A. Wise and V. D. Hopkin. *Handbook of Aviation Human Factors*. Mahwah, NJ : Lawrence Erlbaum Associates, 1999.

SEAFARERS EDUCATION, TRAINING AND CREWING IN UKRAINE

MYKHAYLO MIYUSOV, VADYM ZAKHARCHENKO

National University “Odessa Maritime Academy” (NU “OMA”)
8, Didrichson str., 65029, Odessa, Ukraine
e-mail: rector@onma.edu.ua, zvn@onma.edu.ua, http://onma.edu.ua

Keywords: Maritime Education and Training, Crewing, Certification

Abstract. Ukrainian National Certification Regulations should be amended because of the changes in the higher education structure. The level of training of NU “OMA” graduates meets the requirements of international shipping and crewing companies. This fact explains the interest of world shipping leaders in Ukraine. Changes in maritime education and training system in Ukraine will widen the possibility for Ukrainian officers’ employment.

1 INTRODUCTION

Nowadays, Ukraine is among leaders as for officers’ supplying country to the world maritime labour market. Changes in maritime education and training system in Ukraine will widen the possibility for Ukrainian seafarers to be employed on board vessels entitled to fly the flags of almost all countries, in all basins of the oceans, and contribute to the high prestige of our maritime personnel and enhancement of the positive image of Ukraine.

2 GLOBAL DEMAND FOR SEAFARERS AND THE ROLE OF UKRAINE

According to the information of the United Nations Conference for Trading and Development (UNCTAD) [1] and in accordance with the report of BIMCO/ISF [2] world maritime fleet supplies about 1545000 working places for the seafarers in international shipping. Nearly 51% of positions are for officers, 49 % – for ratings (there was a correlation of 45 % officers to 55 % of ratings). It is the first time in the history when the officers' rate became larger in comparison to ratings. It can be explained by the technology progress and lower demand for hand labour on board. Level of ships’ automation is constantly rising and the shipowners tend to find a balance between the expenditures on upkeep of a qualified crew and losses from insufficient and non-professional maintenance of ships' machinery. Recent years has seen the activation of technological, normative and legal projects which are necessary to bring autonomous and unpiloted vessels into reality. Construction and prototype testing of the first vessel like that is planned to be realized in 2018 [3, 4].

Working onboard is an example of importance of the economy from the scales in shipping. For example, a crew of 14-15 people is required for *колона* container vessel or a bulk carrier with a gross tonnage of 10000 tones. A vessel which is 10 times larger (100000 tones) doesn't require 10 times more people and can operate well with a crew of 19-20 people. During 2005-2015 a global demand for seafarers increased up to 45% which corresponds to the

increase of world shipping for the same period. The biggest amount of seafarers is provided by China (243635), followed by Philippines (215500), Indonesia (143702), Russian Federation (87061), India (86084) and Ukraine (69000) [2]. There is an analysis concerning the number of seafarers including the officers taking into account the population [5] of the above-mentioned 6 countries which provide the biggest amount of the seafarers for global shipping. As it can be seen from the Table 1, Philippines and Ukraine provide a relatively biggest amount of the seafarers. If taking into account the officers' supply, Ukraine is a leader among the other countries including Philippines. Taking into account the population size, the amounts of money that seafarers working abroad transfer to their countries are much more important for the Philippines and Ukraine than for other major suppliers. In the Philippines amount of money transferred by seafarers amounted to 5.8 billion US dollars in 2015, showing the rise of 5.3 percent compared to 2014 [1].

Table 1: Absolute and relative rates of seafarers' supply to the international labour market considering population

| | Country | Population (<i>P</i>) (2017) [5] | Supply of seafarers [2] (<i>SS</i>) | Supply of officers [2] (<i>SO</i>) | <i>SS/P</i> , % | <i>SO/P</i> , % |
|---|-------------|------------------------------------------|---------------------------------------------|--------------------------------------------|-----------------|-----------------|
| 1 | China | 1,409,517,397 | 243,635 | 101,600 | 0.017 | 0.0072 |
| 2 | Philippines | 104,918,090 | 215,500 | 72,500 | 0.205 | 0.0691 |
| 3 | Indonesia | 263,991,379 | 143,702 | 51,237 | 0.0544 | 0.0194 |
| 4 | Russia | 143,989,754 | 97,061 | 47,972 | 0.0674 | 0.0333 |
| 5 | India | 1,339,180,127 | 86,084 | 69,908 | 0.0064 | 0.0052 |
| 6 | Ukraine | 44,222,947 | 69,000 | 39,000 | 0.156 | 0.0882 |

It should be noted that the BIMCO/ISF researches were carried out taking into account information provided by the relevant maritime administrations of the countries and leading shipping and management companies. The received data were corrected. For example, data provided by China and the Philippines were reduced approximately by half, and data provided by Ukraine – by more than three times. For this reason the abovementioned numbers are very approximate. On the ground of the information received from the companies, BIMCO/ISF put China, the Philippines and the Russian Federation at the first place, Ukraine was put at the fourth place, and India was put at the fifth place [2]. Significantly, China is thought to have overtaken the Philippines as the largest single source of seafarers qualified for international trade. However, data from international shipping companies suggests that the extent to which these Chinese seafarers are available for service on foreign-owned ships may be limited, with the Philippines and Russia seen as equally important sources of officers, followed closely by Ukraine and India [2]. It should be pointed out that there is no statistical recording of the number of seafarers in Ukraine. The number of seafarers can be indirectly estimated by the number of certificates of competence issued for officers and certificates of proficiency issued for ratings. According to the State Register of Seafarers' Documents of Ukraine, as of the end

of 2017, the following number of qualification documents with the right to occupy positions on sea-going vessels in accordance with the Manila amendments to the STCW Convention and the STCW Code were issued to Ukrainian seafarers: Master – 9,287, Chief mate – 7,669, Watch officer – 12,701, Chief engineer officer – 9,400, Second engineer officer – 6,876, Watch engineer officer – 11,352, 1st Class electro-technical officer (ETO) – 1,593, 2nd Class ETO – 1,132, 3rd Class ETO – 3,402, Able seafarer deck – 11,170, Ratings forming part of navigational watch – 15,738, Boatswain – 2,667, Able seafarer engine – 6,066, Ratings forming part of an engine-room watch – 10,726, Electro-technical ratings – 2,141. Total number of valid seafarers' certificates issued in Ukraine – 111,920, including: Masters and officers – 63,412, Top officers (management level) – 33,232, Officers (operational level) – 30,180, Ratings (support level) – 48,508, Masters and deck department – 59,232, Engine department – 52,688. Taking into consideration inappreciable national fleet of Ukraine, most of seafarers work in foreign shipping companies. It should be noted that the given data do not include seafarers who occupy service staff positions, such as cook, steward, workers of the hotel department of passenger ships, and others.

On 29 August 2017 published Seafarers' Statistics in the EU [6]. The statistical review presented in this report is based on data extracted from certificates and endorsements registered by EU Member States until 31 December 2015 and recorded in the STCW Information System (STCW-IS). It represents a snapshot of the European labour market in terms of the number of seafarers holding valid certificates and endorsements in 2015. The data included now in the STCW-IS shows that 182,662 masters and officers hold valid certificates of competency (CoCs) issued by EU Member States while another 102,861 masters and officers hold original CoCs issued by non-EU countries with endorsements issued by EU Member States attesting their recognition (EaRs). The five EU Member States that had more masters and officers holding CoCs issued by them in 2015 were the United Kingdom (31,448), Poland (20,700), France (13,552), Croatia (13,350) and Spain (11,697). In addition, the five EU Member States that had more masters and officers holding EaRs were Malta (63,142), Cyprus (29,654), the United Kingdom (15,779), the Netherlands (10,104) and Luxembourg (6,761). Finally, the five non-EU countries which had more masters and officers holding their CoCs recognized by EU Member States were the Philippines (33,966), Ukraine (23,192), Russian Federation (16,381), India (7,626) and Turkey (6,377).

The name of the country that issued the original CoC was made available for 150,415 masters and officers based on the data received from the 24 EU Member States that issued EaRs. This represents 99.88 % of the total number of officers at EU level holding valid EaRs. The masters and officers registered with valid EaRs held original CoCs issued by 88 countries. Figure 1 identifies 19 countries, of which twelve are EU Member States and seven non-EU countries, which provided 88.36% of the total number of officers holding valid EaRs at EU level. It should be noted that the report [6] is the second of research conducted by EMSA. The first report was published in 2016 on the base of the data in STCW-IS by the end of 2014 [7]. As the additional data was collected during the previous year, the possibility to analyze trends for better understanding of maritime labour market in Europe appeared. In the table 2 there is information concerning the number of confirmations of competency certificates issued by the EU for Masters and officers according to the countries where the

original certificates were issued as well as absolute and relative increase of this number. During the year an overall number of registered confirmations increased up to 13 % [6]. Turkey has seen the largest increase of 32 %.

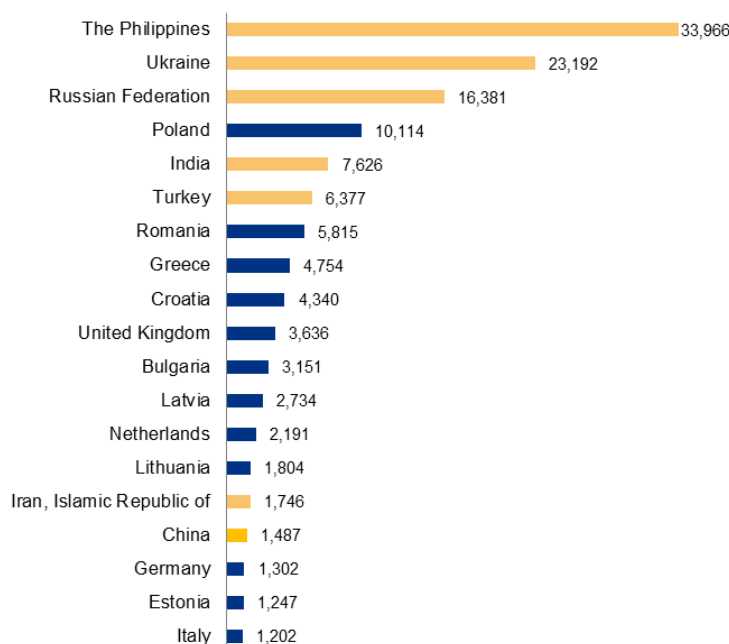

Figure 1: Countries issuing the original CoCs registering more than 0.75% of masters and officers holding valid EaRs

Table 2: Distribution of holders of valid confirmations of competency certificates issued by the EU countries according to the countries where the original certificates were issued

| Country | At the end of 2014 | At the end of 2015 | Growth | Growth, % |
|--------------------|--------------------|--------------------|--------|-----------|
| Philippines | 28,874 | 33,966 | 5,092 | 17.6 |
| Ukraine | 19,363 | 23,192 | 3,829 | 19.8 |
| Russian Federation | 13,645 | 16,381 | 2,736 | 20.0 |
| Poland | 8,739 | 10,114 | 1,377 | 15.6 |
| India | 6,401 | 7,626 | 1,225 | 19.1 |
| Turkey | 4,830 | 6,377 | 1,547 | 32.0 |

2. THE EDUCATION AND CERTIFICATION SEAFARERS' SYSTEM

The education and certification Seafarers' system in Ukraine is in compliance with the requirements of the STCW Code and STCW Convention including the Manila Amendments. In particular, the training programs, implementing the standards of operation and management level competence of the new edition of the STCW Code, are realized in maritime educational

institutions since 2012 [8]. The specialists' training in the seagoing specialties in compliance with the requirements of the STCW Code and STCW Convention in Ukraine is conducted by 7 higher educational establishments (including their branches). Table 3 provides information on the number of students enrolled in 2017 for the first year of study for different educational levels (Junior Specialist, Bachelor and Master) in educational institutions of Ukraine for the specialties (programmes) leading to the obtaining of the certificate of competence in accordance with the STCW Convention. Nowadays Ukraine is in the "white list" of the International Maritime Organization of countries, which completely fulfill the requirements of the STCW Code and Convention. The memoranda of the seafarers' Diplomas (Certificates) recognition were signed by 53 member states of the International Maritime Organization in compliance with the Regulation I/10 of the STCW Convention. Besides, the Seafarers' Training and Certification System in Ukraine is approved by the European Commission on the ground of the periodical inspection results, conducted by the European Maritime Safety Agency (EMSA) against the requirements of the relevant Directive of the European Parliament and European Union Council. The last inspection was held in April 2018. Currently, the conclusion has not yet been provided to the Maritime administration of Ukraine. The Seafarers' Training and Certification is supported by the Ministry of Education and Science of Ukraine (implementation of the training programs, providing achievements of necessary competence standards), Ministry of Health of Ukraine (medical certification) and Ministry of Infrastructure of Ukraine, which functions as a Maritime administration of Ukraine. Ukrainian Seafarers' Training and Education System can be characterized by the obligatory educational degree obtained as a result of successful completion of the formal educational program. This degree allows getting a specific diploma (Certificate of Competency), which gives the right to occupy the officer position on a vessel. There are special rules in Ukraine defining the procedure of rank awarding to the seafarers. Nowadays the powers to approve these rules are given to the Ministry of Infrastructure of Ukraine. According to these rules, a corresponding degree of higher education is an essential condition to obtain the Diplomas (Certificates of Competency), which meet the operation and management level of the STCW Code. The programs of higher maritime education provide realization of the Model Courses of IMO and include an indispensable practical training as the obligatory component [8]. The programs of maritime education combine such components which lead to necessary professional skills as well as the components, providing knowledge and understanding of corresponding sciences, principles of equipment operation and technological processes, development of cognitive skills. As a result, a high level of the Ukrainian seafarers' competence is achieved and the skills of situation awareness and decision making in unforeseen situations and restricted resources conditions are formed.

Accordingly, the officers' training is conducted at higher maritime educational institutions. The training is based on the state and industry-specific standards of the higher education, which are formed in compliance with all the requirements of STCW Convention and STCW Code. Nowadays, the Bachelor Degree is the "basic" higher education degree in Ukraine, which allows the graduates to "obtain the Certificates of Competency" of the STCW Code operation level and join the next higher education cycle, and develop the officer career to the STCW Code management level.

Table 3: The number of students enrolled in 2017 for the first year of study for different educational levels in educational institutions of Ukraine for the programmes leading to the obtaining of the certificate of competence

| № | Educational Institution | Educational level | | | Total |
|-------------------------|--------------------------------------------------------------------------|-------------------|----------|--------|-------|
| | | Junior Specialist | Bachelor | Master | |
| 1 | National University “Odessa Maritime Academy” (Odessa, Mariupol, Izmail) | 574 | 1260 | 160 | 1994 |
| 2 | Odessa National Maritime University (Odessa) | - | 353 | 120 | 473 |
| 3 | Odessa Maritime College of Fish Industry (Odessa) | 471 | - | - | 471 |
| 4 | Kherson State Maritime Academy (Kherson) | 671 | 820 | 340 | 1831 |
| 5 | Kherson Maritime College of Fish Industry (Kherson) | 251 | - | - | 251 |
| 6 | State University of Infrastructure and Technologies (Kyiv) | - | 263 | 75 | 338 |
| 7 | Admiral Makarov National University of Shipbuilding (Mykolaiv) | - | 22 | | 22 |
| Total in Ukraine | | 1967 | 2718 | 695 | 5380 |

3 THE SYSTEM OF UPGRADING AND REFRESHING TRAINING

The important constituent elements for ensuring high competency of Ukrainian masters and officers are mandatory periodical approved refresh and updated courses. System of upgrading courses is regulated by the Provisions for the Procedure of conferring of ranks on officers of seagoing ships. The national requirements stipulate the compulsory completion of such courses not less than once in five years and before obtaining next level Certificate of competency or a certificate endorsement. Work of State Competency Assessment Commissions is provided by the Inspectorate for Training and Certification of Seafarers of the Ministry of Infrastructure of Ukraine. This Inspectorate also ensures seafarers’ register and one of its functions is inspection of seafarers’ documents. We should mention that the function of general management and control over seafarers’ training and certification in Ukraine is carried out by the State Service of Ukraine for Transport Safety. There are 36 training centers including those which form a part of educational institutions providing different kinds of training and upgrading courses in Ukraine approved by the Maritime Administration.

4 THE SYSTEM OF CERTIFICATION OF SEAFARERS

Nowadays, the Certificates of Competency are issued by the Harbour Masters offices on the basis of the Protocols provided by the State Qualification Commission established by the Inspectorate for Training and Certification of Seafarers. National Certification Regulations should be amended as a result of the changes in the higher education structure. New

Regulations should provide, as before, the overall structure of seafarers' training and certification based on the higher maritime educational establishments, and opportunity for the officers to acquire new competences and corresponding new qualifications gradually. Most likely, future Regulations will not consider the Master Degree obligatory for getting Certificate of Competency of the STCW Code management level. At the same time, the officers' essential learning outcomes and competency level can't be achieved in the frames of the Bachelor program, which leads to the Certificate of Competency at the operation level.

5 THE SYSTEM OF SEAFARERS' EMPLOYMENT AND COOPERATION OF THE MARITIME EDUCATIONAL ESTABLISHMENTS WITH SHIPPING INDUSTRY

Over the past decades experience of maritime education development and seafarers' training in Ukraine showed that Ukrainian seafarers, first of all officers, successfully competed on international labour market. The attractiveness of maritime profession for young people has been increasing, the number of Ukrainian seafarers at world shipping fleet is rising, higher educational establishments and training centers have been developing and service market on seafarers' crewing has been expanding. Such dynamics of development has been possible now due to the cooperation of shipping companies, crewing companies and agencies with educational establishments. Companies that provide employment services for seafarers can start work only after obtaining a license. Ministry of Social Policy of Ukraine, on behalf of the State, issued licenses to more than 350 companies and other business entities.

Many foreign companies with long-term programs for Ukrainian seafarers on board their vessels invest significant funds into personnel training with the help of their own "cadets programs", giving sponsor support to maritime training institutions, creating their own training centers. The most active companies on the Ukrainian market in this direction are: V.Ships, MSC, OSM, Anglo-Eastern, BSM, Columbia Shipmanagement, Marlow Shipmanagement, Stolt-Nielsen Transportation, MOL, K-Line, etc. In the framework of cadets programs together with training institutions they select cadets in compliance with the company's requirements (knowledge of English, professional training, necessary certificates), organize planning and control over complying with on-board training programs. Companies cover all expenses connected with on-board training. It should be emphasized that almost all companies have their representative offices in a large number of maritime countries of the world. The level of training of our graduates meets the requirements of our partners. This fact explains the interest of international shipping leaders in Ukraine.

7 CONCLUSIONS

Taking into account all above-mentioned we consider the following as the perspectives of development:

1. Promoting an integrated approach to maritime affairs, good governance and exchange of best practices in the use of the marine space;
2. Promoting sustainable development of coastal regions and maritime industries as a generator of economic growth and employment, including through the exchange of best practices;

3. Promoting strategic alliances between maritime industries, services and scientific institutions specializing in marine and maritime research, including the building of cross-sectoral maritime clusters;

4. Endeavoring to improve maritime safety and security measures and to enhance cross-border and cross-sectoral maritime surveillance to address the increasing risks related to intensive maritime traffic, operational discharges of vessels, maritime accidents and illegal activities at sea;

5. Support of cadets' on-board training by all interested parties including companies, IMEC and other organizations, maritime administrations, International Maritime Organization, reconstruction and maintenance of training vessels;

6. Motivation of professors and instructors of educational establishments from the side of the companies, providing opportunities of working at sea and at educational institutions including internships and cadets' training supervision.

REFERENCES

- [1] Review of Maritime Transport 2016 / Report by the UNCTAD secretariat. – New York and Geneva: UN, 2016. – 116 p.
- [2] Manpower Report: The world supply and demand for seafarers in 2015// BIMCO/ISF. – 2015. – 118 p.
- [3] Rolls-Royce opens autonomous ship research and development centre in Finland. Available from: <<https://www.rolls-royce.com/media/our-stories/press-releases/2018/25-01-2018-rr-opens-autonomous-ship-research-and-development-centre-in-finland.aspx>>.
- [4] World's First Autonomous Ship to Launch in 2018. Available from: <<http://fortune.com/2017/07/22/first-autonomous-ship-yara-birkeland/>>.
- [5] Countries in the world by population. Available from: <<http://www.worldometers.info/world-population/population-by-country/>>.
- [6] Seafarers' Statistics in the EU. Statistical review (2015 data STCW-IS). Lisbon: EMSA, 2017. Available from: <<http://emsa.europa.eu/emsa-documents/latest/item/3094-seafarer-statistics-in-the-eu-statistical-review-2015-data-stcw-is.html>>.
- [7] Seafarers' Statistics in the EU. Statistical review (2014 data STCW-IS). Lisbon: EMSA, 2016. Available from: <<http://www.emsa.europa.eu/emsa-documents/latest/item/2779-seafarer-statistics-in-the-eu-statistical-review-2014-data-stcw-is.html>>.
- [8] Miyusov, M.V. and others. Implementation of the 2010 Manila Amendments to the STCW Convention and Code in Ukrainian MET System. In: Logistics and Economic Matters – Marine Navigation and Safety of Sea Transportation. London: Taylor & Francis Group, 2013, pp. 55-59.
- [9] Miyusov, M.V. Upcoming Changes in Ukrainian Maritime Education and Certification System. International Scientific Conference “Science and Technology for Sustainable Maritime Development”: Conference Proceedings, Varna: Nikola Vaptsarov Naval Academy, May, 13-14, 2015, pp. 72-77.

THE DEVELOPMENT OF A QUALIFICATION BOARD TO DOCUMENT ENGINEERING CADET PERFORMANCE AS PART OF A TRAINING PERIOD AT SEA

Mark A. Côté

Maine Maritime Academy
Engineering Department
Castine, ME USA

e-mail: mark.cote@mma.edu, web page: <http://www.mainemaritime.edu>

Keywords: Engineering, Cadet Assessment, At-sea Training

Abstract. This paper describes the assessment review conducted by the Engineering faculty at Maine Maritime Academy (MMA) and the resulting decision to implement a process of a Qualification Board for junior engineering cadets. The pre-existing assessment methodology will be detailed and the process of developing and implementing the Qualification Board Process prior to and during the 2018 MMA Training Cruise will be described.

The use of a Board of Senior Officers to conduct a final review of a mariner's readiness for additional responsibilities has been a part of many Navy's officer qualification processes for hundreds of years. This paper will detail some of that history, as well as the methods used for cadet assessment by MMA through the 2017 Training Cruise conducted by the school. That process involved multiple methods of assessment and concluded with a final assessment day that included examinations, demonstrations, and completion of cruise and Standards of Training, Certification, and Watchkeeping for Seafarers (STCW) checklists (check-offs). As part of MMA's continuous improvement process and surveys of both cadets and instructors, there was a general dissatisfaction concerning both the operation of this process and its efficacy in actually reflecting the cadet's knowledge and performance.

As a result, the overall assessment plan has been modified and, as part of this change, a final Qualification Board will be added for each junior engineering cadet. The details of this process will be discussed in the paper, but the Qualification Board will provide for a more structured and interactive final assessment, with clear methodologies and standards for successful completion. Additionally, the Qualification Boards replace the "Flashlight Examinations" which took place in the engine room and had limited effectiveness due to the test environment. This assessment will allow the cadet to demonstrate knowledge of the subject materials and skills, while also allowing evaluation, by multiple senior officers, of the cadet's maturity and performance during a stressful situation. The Qualification Board is expected, when combined with the other aspects of the

assessment program to be detailed in the paper, to provide a more complete and accurate assessment of each cadet’s readiness for his/her career.

Ninety-Six (96) Qualification Boards were conducted on the 2018 Summer Sea Term. The process evolved as the series of examinations occurred, using feedback from both faculty and cadets. Overall, the process fulfilled the goal to improve the overall assessment of junior engineering cadets. Specifics of the process and results will be detailed in the paper and conference presentation. This added assessment technique appears to have merit and likely would improve the assessment of practical skills and knowledge at any maritime university.

1 INTRODUCTION

There are a number of ways of assessing student performance, including examinations, observation of specific activities, and individually observed demonstration of specific skills or knowledge. When evaluating the performance of engineering cadets during the at-sea portion of their training to become professional mariners, there often have been questions regarding the efficacy of these assessments to measure their readiness for the merchant marine. This paper will highlight the assessment methods used to determine an engine cadet’s performance during the MMA Annual Training Cruise and the development and implementation of the new step of using Qualification Boards to improve that process. It is expected that other maritime universities have experienced similar issues and may find the Qualification Board development process and the actual board process itself valid for consideration as part of, and to improve, their student assessment programs.

2 EXISTING PERFORMANCE ASSESSMENT METHODOLOGY

Junior engineering cadets completing the course CE-303 – “Junior Cruise (Engineering)” during the 2017 summer sea session were assigned a course grade based on the following assessments:

- | | |
|-------------------------------------|-----------|
| 1. Quizzes | 15 Points |
| 2. Final Exam | 15 Points |
| 3. Plant Analysis Project | 15 Points |
| 4. Maintenance Performance | 6 Points |
| 5. Regimental Performance | 7 Points |
| 6. Watchstanding Performance + Test | 7 Points |
| 7. Flashlight Exam | 20 Points |
| 8. Systems Drawing | 10 Points |

During this course, junior engineering cadets were separated into four administrative companies. The companies then rotated through multiple iterations of four assignments: Watch, Ship Maintenance, Training, or Utility. For a watch assignment, the cadets stood two, four-hour watches in the engine room per day, supporting engine room operations. On a maintenance day, the cadets were assigned to one of the ship’s crew for an eight hour period supporting ship upkeep and repairs. During training, the cadets participated in up to eight hours of classroom

lectures, as well as demonstrations and practice of engineering activities, such as obtaining main engine firing pressures or disassembly and cleaning of an oil purifier. On utility, junior cadets worked with and supervised first-year cadets in general ship cleaning and upkeep activities for an eight hour shift.

During the training periods, the cadets were taught by MMA faculty and experienced engineers from industry. Topics covered included an in-depth review of training ship systems, as well as applicable industry topics such as high voltage power systems and the use of standard operating systems. Assessments were built into this training and included a daily written quiz on the prior training day's material.

Cadet assessment ended with a final training day just before the end of the cruise. This day included three major assessment tools:

1. A "Flashlight Exam." During this evaluation, cadets were randomly assigned to one of several areas of responsibility in the training ship engine room. They met there with an assigned faculty member and had to locate specified components, describe the operation of plant equipment, and answer questions regarding ship operations. This examination was typically conducted over a 20 to 25 minute period for each cadet and five parallel evaluations were conducted at a time in different areas of the engine room. The noisy environment limited cadet-faculty interaction and often caused confusion and lack of clarity during communications.
2. A System Drawing. Each cadet was required to create a one line diagram of a specified ship system drawn from a list of six systems.
3. A Final Examination. An examination over the topics covered during the cadet's training days. The test typically consisted of 3-5 multiple choice questions over each subject area included in the Training curriculum for the at-sea period.

The total weighting of these assessments factored as 45% of the cadet's overall cruise grade.

While this program of final assessment had been in place for several years, both the students and faculty had begun to realize that this program could be improved. During the 2017 at-sea training period, 31 junior engineering cadets drafted and submitted a letter to the training staff indicating dissatisfaction with the current program evaluation process. Among other points, they stated that "We do not feel that the existing training program does a great job of accurately assessing our knowledge of this vessel." This feedback was one of the final pieces of input to support the action to conduct a major revision to the assessment methods for the at-sea session and CE-303.

3 ISSUES WITH EXISTING ASSESSMENT METHODOLOGY

The existing training and assessment program had evolved over several years and certain aspects of the program had been normalized in ways that resulted in a reduced effectiveness in student learning and assessment of that learning. In some cases, course material had devolved to "teaching to the test" and in other instances, students would focus on the testable material almost to the exclusion of general knowledge and understanding of ship systems and good operational

practices. In fact, one of the chief complaints in the student letter mentioned above was that “The part that we feel needs to be changed is the memorizing of plant schematics.” This was contrary to the actual teaching practices, and how the ship systems were introduced, which clearly stated that overall understanding of the system was expected, that the cadets were expected to trace each assigned system, and that a system sketch was only one part of the evaluation. From the student’s perspective, this had devolved to a requirement to memorize a system sketch which had become available via their predecessors. Significant cadet time was spent memorizing the drawings, in some cases with minimal understanding of the actual system in the engine room. Additionally, the “Flashlight Examinations” which took place in the engine room had limited effectiveness due to the test environment. This often caused confusion and limited the ability of faculty to provide effective feedback and corrections during the examination.

4 ASSESSMENT METHODOLOGY CHANGES CONSIDERED

The Engineering Faculty, as part of the school’s continuous improvement program, meet at the conclusion of each at-sea period to conduct an after action review of that year’s session. In 2017, the result of that review concluded that changes should be made to the assessment program. Key items considered included:

1. How to increase student engagement, especially to foster “buy in” to the at-sea session as an overall learning experience.
2. How to better capture student activities during the at-sea session to increase the faculty’s understanding of what students were actually doing when they were not in Training.
3. How to best assess the competence of these Cadets who were within one year of reporting to a ship as a Junior Officer.

In order to address the observed weaknesses in the existing program, the faculty considered several changes to the assessment process:

1. Developing a way to capture student actions and understanding and including an evaluation of these data in the overall assessment process.
2. Providing assessment methods where the process evolved from a “snapshot” of the student’s capabilities at a point in time and included the ability to correct and guide the students during the assessment process.

Complicating this evaluation was a change to the overall at-sea training program which resulted in junior engineering cadets participating in a 35-day 2018 cruise rather than the prior year’s 45-day period.

5 PLANNED ASSESSMENT METHODOLOGY CHANGES

After some consideration and discussion, the Engineering Faculty, determined that, as a first step, two major assessment changes would be implemented:

1. Junior engineering cadets will be required to maintain a Cruise Journal. This physical record of their at-sea training will be used for both periodic and final assessment as described below.

2. A Qualification Board will be put in place to replace the “Flashlight Exam” and the system sketch. The rationale for this change and the proposed process are described below.

An additional key factor to successfully implement these changes is the support of the training ship’s crew, especially the watch standers in the engine room.

6 THE CADET ENGINEERING JOURNAL

To provide a standard basis for evaluating student actions, a daily cruise journal was implemented. Students were required to purchase a blank (6” X 9”) journal book from the MMA bookstore and were provided with guidance on journal entries, as well as examples of a typical day’s entries for each of the different assigned activity days. The guidance details included:

1. “Start each day’s record on a new right-hand page, with the day of the week, date and your company’s assignment(s) for the day (Utility, Training, Watch, or Maintenance.
2. As you record activities, you can continue onto the backside of each page and/or additional pages as necessary, but start each new day on the next blank right-hand page.
3. Throughout the day and/or watch, record major activities. The entries should be written in past tense, documenting the time each event started to fully document the day’s Cruise actions.”

The journal write-ups will be a key part of the assessment for Watch and Maintenance Grades, as well as forming the basis for discussion during the Cruise Qualification Boards. The completed journal will be turned in to the Senior Engineering Training Officer by 1630 the day before each company’s last day, and will be used as part of the Cruise Qualification Board. A properly completed journal must be turned in to meet course requirements.

7 THE QUALIFICATION BOARD

The use of a board of senior officers to conduct a final review of a mariner’s readiness for additional responsibilities has been a part of many Navy’s officer qualification processes for hundreds of years. For example, beginning in the 17th century, Great Britain’s Royal Navy required all Lieutenants to pass a Navigation examination conducted by a board of senior officers. Additionally, as a more current example, during a typical United States Navy deployment period, the USS Crommelin conducted qualification boards for the Engineering Officer of the Watch, Command Duty Officer, and Surface Warfare Officer positions.

This evaluation was often the final assessment before an officer was allowed to independently stand watch and assume the full responsibilities of his/her position. The process has been found to be an effective assessment, in that it provides for a more interactive evaluation of the candidate’s understanding and preparedness for the role and allows the reviewing officers to teach and guide, as well as determine the final readiness for the position for whichever qualification was being assessed.

In adapting the process for engineering cadets, MMA faculty integrated the formal board with the use of the cruise journal to attempt to better capture the students’ status relative to course and

program requirements, as well as their preparedness for the role of professional mariner. The general guidelines for the Board were established as follows:

1. The board will be composed of three engineering training officers or members of the ship's crew.
2. The duration of the board will be limited to 20 minutes.
3. Cadets will be assessed over these items:
 - A. A ship system - Its Purpose/Functions, Key Operating Parameters, Operation of Key Equipment, and will include a system one-line diagram sketch (Major Flow Path only) drawn on the Classroom Board.
 - B. Any of the Cruise or Standards for Training Certification and Watchkeeping (STCW) Check-offs
 - C. Proper Watchstanding and Operations Practices
 - D. Topics of Interest from the cadet's Cruise Journal.
 - E. The Cruise Power Plant Project, oriented to key topics rather than on detailed calculations.
 - F. Other topics as determined by the Examining Officers.

The three examining officers will direct questions to the cadet following these basic guidelines, but may expand or re-visit any topic depending on the cadet's previous answers. Officers will record their evaluation of the cadet's performance on a provided grading sheet and issue a letter grade for the board based on the following metric:

1. The board will use the following metric in assigning Board Results as a letter grade (+/- Grades are allowed):
 - A. Cadet was outstanding. System description and sketch demonstrated clear understanding of the machinery and operation of the system. Cadet clearly demonstrated the Cruise/STCW Check-off skills or knowledge assessed by the Board. Cadet spoke clearly, provided timely answers, made eye contact and was confident in her/his responses to the Board's questions.
 - B. Cadet was very good. System description and sketch demonstrated good understanding of the machinery and operation of the system. Cadet demonstrated, with minimal prompting from the Board members, the Cruise/STCW Check-off skills or knowledge assessed by the Board. In general, the cadet spoke clearly, made eye contact and was confident in her/his responses to the Board's questions.
 - C. Cadet responses were adequate. System description and sketch demonstrated basic understanding of the machinery and operation of the system. Cadet demonstrated, with some prompting or guidance from the Board, the Cruise/STCW Check-off skills or knowledge assessed by the Board. For most of the board's duration, the cadet spoke clearly, made eye contact and was confident in her/his responses to the Board's questions.

F. Cadet did not meet standards. System description and sketch did not demonstrate basic understanding of the machinery and operation of the system. Cadet could not demonstrate the Cruise/STCW Check-off skills or knowledge assessed by the Board. The cadet did not speak clearly, avoided eye contact, and was not confident in her/his responses to the Board's questions, even with significant prompting and clarifying questions or comments from the Board.

Should the student performance warrant a lower grade, board officers may assign a numeric grade below 65%.

2. The three officer grades will be averaged and a final board grade will be assigned for each cadet. The use of three separate perspectives should decrease the variability between the assessments and will result in a grade that more accurately captures actual student performance.
3. This assessment will allow the cadet to demonstrate knowledge of the subject materials and skills, while also allowing evaluation, by multiple senior officers, of the cadet's maturity and performance during a stressful situation.

Prior to starting this process, all Training Officers will receive an overview of the process and review expectations and guidelines for their conduct during the board and how results will be compiled and recorded. Additionally, a mock qualification board will be conducted for each company of cadets so that they can understand the format of the evaluation and ask questions about the process before their actual session. Each student will be assigned a specific time and place for their board session and it is expected that, with two boards proceeding in parallel, each company's boards will be completed in less than three hours. The four mornings of qualification boards, one for each cadet company, will take place as close to the completion of the at-sea period as possible.

8 REVISED COURSE ASSESSMENT

With the implementation of the cruise journal and qualification board, the grade for the 2018 session of CE-303 will be determined using the following assessments:

Evaluation:

- | | |
|------------------------------|----------------------|
| 1. Quizzes | 10 Points |
| 2. Final Exam | 10 Points |
| 3. Plant Analysis Project | 15 Points |
| 4. Maintenance Performance | 15 Points |
| 5. Regimental Performance | 10 Points |
| 6. Watchstanding Performance | 15 Points |
| 7. Qualification Board | 20 Points |
| 8. Cruise Journal | 5 Points & Pass/Fail |

The expected result of these changes is a better understanding of each student's readiness for his/her career and a grade for the course that more accurately reflects that actual condition.

9 RESULTS OF THE MODIFICATION TO THE ASSESSMENT PROCESS

Ninety-Six (96) Qualification Boards were conducted on the 2018 Summer Sea Term. Prior to the Final Assessment Day, a “Mock Board” was conducted with a volunteer cadet and cadets were able to observe the process and ask questions regarding the scope and methods. Several of these “Mock Boards” were recorded as video and these videos were made available to the cadets on the ship’s server. The process evolved as the series of examinations occurred, using feedback from both faculty and cadets. Specifically, it was determined that, unlike a traditional Qualification Board, where the cadet would be evaluated as meeting or not meeting the Board requirements, in order to assign a numerical grade, each question asked would be assigned a grade. The question grades were then averaged to determine a grade for the Qualification Board. The average grade for the Qualification Boards was a C+ and the grade distribution exhibited the expected range, with several outstanding performances and a smaller number of students not performing well. Additionally, the use of Cruise Journals provided significant insights into cadet activities, especially their actions outside of scheduled Training days. It is expected that, with this data, additional changes may be made to the overall sea session to improve the cadet experience. Overall, the process met faculty expectations and fulfilled the goal to improve the assessment of junior engineering cadets. Additional specifics of the process and results will be detailed in the conference presentation.

10 CONCLUSION

This paper has described the issues with student assessment on prior MMA at-sea sessions, the review conducted to develop and implement improvements to the process, and provided the specific details, expectations and results of the changes implemented on the 2018 Training Cruise. The new assessment methods, including the use of a final Qualification Board, appear to have allowed for a more accurate and complete assessment of student capabilities and outcomes. The processes described was implemented during the 2018 at-sea session and additional results will be described during the presentation of this paper in October 2018. This added assessment technique appears to have merit and likely would improve the assessment of practical skills and knowledge at any maritime university.

REFERENCES

- [1] Rodger, N. Commissioned officers' careers in the Royal Navy, 1690–1815. In: *Journal for Maritime Research* [online] 2001 3:1, 85-128. [viewed date 24 May 2018]. Available from <<https://doi.org/10.1080/21533369.2001.9668314>>
- [2] Landers, C. Command History 1989 (OPNAV REPORT 5750-1) [viewed date 24 May 1989]. Available from<<https://www.history.navy.mil/content/dam/nhhc/research/archives/command-operation-reports/ship-command-operation-reports/c/crommelin-ffg-37-i/pdf/1989.pdf>>

IAMU-PAES-P PROJECT IMPLEMENTATION BENEFITS: THE MAAP EXPERIENCE

ANGELICA M. BAYLON

* External Relations Office
Maritime Academy of Asia and the Pacific (MAAP)
Kamaya Point, Brgy. Alas-asin, Mariveles, Bataan, Philippines
email: ambaylon@gmail.com, <http://maap.edu.ph>

Abstract. *This paper presents a study on the benefits of the Peer-Assisted Self-Evaluation Scheme (PAES)-P (Philippines) conducted on October 25-26, 2017 in MAAP Philippines, by a group of international experts from IAMU. Further, this paper presents background and rationale on the participation of MAAP, the purpose, and tools used in the PAES-P self-evaluation; the principles, methods, process, phases, and tools used in the PAES-P peer – evaluation; the PAES evaluation form and its coverage. Further, the benefits from the PAES-P project as perceived by the MAAP community composed of the MAAP officers, faculty and staff and by the randomly selected students who were interviewed in the process were analyzed. The 30 comments or qualitative data generated were reduced to 20 and further quantified using the Likert 5-rating scale to determine the extent of satisfaction on the identified benefits of the said project. Likewise, the 20 comments were categorized or summarized into eight significant benefits, and the MAAP community ranked the same. The eight implementation benefits were abbreviated as IAMU-PAES with identified P or perceived Problems or challenges in the implementation of the IAMU-PAES-P project. The paper ends with concluding remarks and recommendations.*

INTRODUCTION

This paper focuses on the implementation benefits of the *IAMU- PAES-P project* at the Maritime Academy of Asia and the Pacific which was conducted in partnership with the Philippine Maritime Industry Authority (MARINA). The PAES-P project consists of 3 distinctive phases: Self- evaluation; Verification and Validation.

Self-evaluation

Evaluation is a process of judging the value of institutional accomplishments. It is an act or process that involves the assignment of a numerical index to whatever is being assessed. Evaluation is an act or process that allows one to make judgment about the desirability or value of a measure. Self- Evaluation, on the other hand, is defined according to De McFarland as judging the quality of one's work based on evidence and explicit criteria to do better work in the future. Riley Guide on the other hand, defines self-evaluation as looking at progress, development, and learning, to determine what has improved and what areas still need improvement. Usually involves comparing a *"before situation with a current situation."*

In this PAESP project, self-evaluation is defined as rating the entire MAAP institutional system based on personal opinion on the prevailing or current situation at the time the various areas with statements have been measured or evaluated. Self- evaluation was done using the PAES evaluation forms. The PAES self-evaluation forms consist of statements describing academics or STCW standards, covering a distinctive group of activities typically done in a modern higher educational MET institution, with marks ranging from 0- 10 of a degree of compliance for each statement. The PAES form covers nine (9) areas: *Organization and Management; Students, Program, Education and Process; Academic Staff and support Personnel; Professional Training and Internships; Facilities and Resources; Program objectives and stakeholders involvement and Continuing Education*

The said forms were rated by three (3) MAAP evaluators namely: *The Quality Management Representative (QMR); the Assistant Vice-President for Academics (AVP) and his Academic Dean*. All these three have management experiences and were requested to answer the survey forms based on his opinion of the entire MAAP institutional system on the current situation at the time the questionnaire have been rated. All the answers have been standardized using the standardization formula: $Z = (X - u)/6 + 5$. Wherein: x is the mark given to the degree of compliance with the statement

u is the mean value of all marks given by one person

6 is the standard deviation of the whole set of marks and

5 is added to make the data more meaningful

Scores have been assigned to the PAESP evaluation forms by MAAP self-evaluators, and the scores has been computed by the MAAP External Relations Office (ERO) using the standardization formula. The entire accomplished excel file was then forwarded to the PAES-P team for peer assistance to further evaluate MAAP, if MAAP is on the right track and to suggest areas to be improved to be globally competitive per international standards.

Verification

The basis of external peer evaluators were those supplied in advance by the host institution. These include the PAES forms accomplished in September 2017, by not more than three senior staff at MAAP (Quality Management representative *Mr. Michael Amon*, the Asst Vice President for Academics *Dr. Leogenes Lee* and the Academic Dean *Capt. Daniel Torres*). Other basis includes data collected from the institution's web pages and other web-

based sources of information, including data available from other official sources, before their visit at MAAP on October 25-26, 2017. During the two day visit of the IAMU-PAES *Working Group (WG) Team*, there were twenty-seven (27) from the MAAP community led by MAAP President Vadm Eduardo Ma R Santos, AFP (Ret), who have been involved either directly (interviewed) or indirectly to verify the accomplished PAES forms.

The tools for PAES peer evaluation included meetings and interviews with the management and staff responsible for the different areas listed in the PAES form. Supporting academic staff and students from all years of study were also interviewed. Various MAAP documents, resources, and facilities following the site visit program schedule were visited. Various documents were shown thru both formal and informal procedures. The checklist provided guidance in collecting relevant evidence used to determine the merits, worth or significance of the nine areas indicated in the PAESP form.

The PAES project followed the principle of peer evaluation wherein the peers are of the same rank. Hence, the external peers were either Vice-President, Dean or Head of a Maritime Program while those who answered the PAESP forms from MAAP were the Assistant Vice-President, the Dean, and the QMR. The peer evaluation conducted was a process by which ones' colleague assesses the other colleagues' quality and accuracy against accepted standards and vice versa. It is indeed an organized effort, whereby practicing professionals review the quality and appropriateness of services rendered or performed by their professional peers. They had conducted direct observation and also had passively and actively engaged in various activities while at MAAP. The conduct of peer evaluation at MAAP was brief, but it was based on objective methodologies with trained observers who provided constructive feedback under an open communication and trust.

Validation

After the external peers had verified and learned in depth about MAAP's mode of operation and its compliance with general educational principles and PAES statements, on February 11, 2018, MAAP finally received the 14-page PAES-P report on MAAP site visit. The report consists of commendable findings in the nine areas: *Organization and Management; Students; Programs; Education and Process; Academic Staff and Supporting Personnel; Professional Training and Internships; Facilities and Resources; Program Objectives and Stakeholders Involvement and Continuing Education*. Importantly, the report has valuable suggestions to improve the overall educational experience at MAAP with emphasis that their recommendations can be carried out as part of the MAAP procedures with no need for the external peers' further involvement.

RELATED LITERATURE OR STUDIES AND METHODOLOGY

This study utilized the following methods of data collection: *observation; interview; questionnaire and literature review search*. There is NO published related literature or studies on how those involved in the implementation of the PAES project view the methods and its benefits. Most of the relevant studies or related works of literature about self or peer assessments deal with different assessment forms and their benefits for students and teachers in general. Hence, this study about the benefits of the PAES-P implementation is a challenge and the first of its kind.

In January 2018, the MAAP community who took part in the (Oct 25-26, 2017) PAES-P site visit was asked individually about their perceived benefits of the PAESP visit at MAAP. The thirty (30) comments were noted, and the same was pilot tested and finally reduced to twenty (20).

In February 2018, the respondents were requested to rate the 20 statements. The fixed choice response formats were designed to measure levels or extent of their agreement or satisfaction to the series of statements. The 20 comments were further analyzed and categorized into eight (8) similar significant benefits which were ranked by the same MAAP respondents.

MAAP satisfaction is defined as the institutional reaction to the salient aspects of the context, process and result of their experience during the PAES-P visit. It may also be described as the extent of the resemblance between the expectations and the lessons or experiences from the visit. The following data collection tools have been used for monitoring MAAP community perceived benefits: *Interview*, *Observation*, and a *Survey Questionnaire* to objectively quantify and validate the qualitative comments generated from the interview. The results or findings are discussed below.

DISCUSSION /FINDINGS

The perceived benefits of the PAESP project Implementation were noted from three (3) perspectives: the **MAAP PAES-P coordinator**/member of the working group; the **MAAP community** who participated directly or indirectly in the PAESP visit and the **MAAP students** who were interviewed:

From MAAP-PAESP- P working group member/coordinator perspective

There was no conflict of interest. As a member of MAAP system serving as IAMU-PAES-P member/coordinator, she did not take part in the interview; nor had influenced the accomplishment of the survey forms. Her participation in the PAESP project was: the initial kick-off meeting held in IAMU headquarters Tokyo Japan in May 2017; the 2nd meeting with the PAES-P team in Varna Bulgaria in Sept 2017 and the needed coordination at MAAP from September to October 2017 for the PAESP site visit at MAAP and STCW 2017 Workshop on “Quality Education at the MHEIs”. Finally, she is tasked to determine the benefits of the PAESP project implementation in the Philippines and present them in the IAMU-MARINA STCW 2018 Conference with theme “*Philippine MET Towards Globally Competitive Officers*” on February 22-23, 2018 at Midas Hotel, Manila

As coordinator, the PAES-P project is perceived as an educational and training experience, with the opportunity to have traveled and learned from foreign counterparts. The PAES-P project had provided copies of many learning materials. The PAES Manual, and most especially the different IAMU works of literature on Key Performance Indicators (KPIs) and papers on managing universities, which were collated and / or prepared by the expert co-IAMU member institutions, are worth reading and sharing. All these documents were shared with MAAP President, MAAP Library, MAAP-QMR and the MARINA-STCW Office.

As a member of the PAES-P team, she was excluded in accomplishing the PAES forms. Nevertheless, as a member of the PAES-P working group, she noted the meager scores of two (2 out of 10) provided by a colleague in charge of the areas/programs being evaluated, believed to be strengths in MAAP. This situation is an example of an internal professional disagreement that is resolved thru the PAES-P project by an external peer.

All concerned at MAAP from top to bottom, strictly followed the PAES-P guidelines to never interfere with the rate provided by colleague's self-assessment or evaluation as it is the role of the external PAES-P working group to validate and give an objective feedback report on their site visit. Indeed, the foreign peer evaluators had provided an actual assessment report with commendable findings. This exercise is believed to be one of the benefits of the

PAES-P project. Those items that were rated low by MAAP, were viewed as commendable and those items that were rated very high by MAAP were provided some suggestions for improvement.

The PAES-P team members had exhibited the highest standard of professionalism, honesty, and integrity in their interaction with the institutional personnel and students which is indeed an excellent learning and networking opportunity, as everyone focused on their similarities rather than differences. This exercise had strengthened the ties or international cooperation between MAAP and co-IAMU member institutions represented by the University of Rijeka, Croatia; SIMAC of Denmark and Chalmers University of Technology of Sweden.

From MAAP Community Perspective

It is deemed sensible to interview the MAAP community who took part in the PAESP visit about their perceived benefits of the PAESP project implementation site visit at MAAP to make the study objective. Thirty (30) comments have been noted, and the same has been reduced to twenty (20) statements. In this paper, an analysis of the views of the MAAP officers /faculty /staff (N= 27) who experienced the PAESP visit with their comments (30 reduced to 20) are presented. A questionnaire has been prepared. The same MAAP community has been requested to rate the following statements, to quantify the 20 perceived benefits. The signed attendance sheet during the PAES visit became the basis for the distributed 27 questionnaires to MAAP officers/faculty/staff. Out of the 27 surveys, only 22 accomplished forms were returned on time, and the same were analyzed using the SPSS version 25. **MAAP President was the first** to submit the accomplished questionnaire to ERO as shown in Figure 1 with his signature. **Table 1** presents the mean perceptions of 22 out of 27 MAAP officers, faculty and staff who participated/interviewed during the PAES-P Site visit. The mean ratings are based on a scale of 1 to 5 with five as the highest and one as the lowest. Evidently, the respondents of this survey provided a relatively overall high regard to the PAES-P implementation visit having a **composite mean of 4.60**.

Table 1: Perceived Benefits of PAESP Implementation Site Visit

| Rank | Name | Mean | Final Rank |
|------|-------------------------------------------------------------------------------------------------------------------------------------------------------------------|------|------------|
| 1 | Provided venue for MAAP share its best practices and initiatives | 4.82 | 1 |
| 2 | Provided information on areas of potential improvement, best practices, or alternatives that will enhance MAAP operation. | 4.73 | 2 |
| 2 | Confirmed that the MAAP documents prepared for PACUCOA Level 3 Accreditation indicates that MAAP system is at par with International standards and best practices | 4.73 | |
| 4 | Provided an objective assessment of MAAP programs and operations | 4.68 | 3 |
| 4 | Supported MAAP's external peer evaluation or benchmarking | 4.68 | |
| 6 | Encouraged the institution to innovate, improve competitiveness, attractiveness and self-perception | 4.64 | 4 |
| 6 | Encouraged teamwork and involvement of all concerned in MAAP processes when preparing for audits | 4.64 | |
| 6 | Lifted MAAP's role and status from being passive to being active IAMU member | 4.64 | |
| 9 | Promoted external objective assessment and critique in order to yield a quality product or program. | 4.59 | 5 |
| 9 | Assured the faculty and administrators that MAAP programs are performing at peak efficiency to meet stakeholder needs | 4.59 | |
| 9 | Encouraged MAAP management and personnel to strive for a more advanced and deeper understanding of its processes | 4.59 | |
| 9 | Encouraged a deeper approach to quality system | 4.59 | |

| | | | |
|------------------|-------------------------------------------------------------------------------------------------------------------------------------------------------------------------------|-------------|----|
| 9 | Brought combined expertise across all areas of administration, unlikely to occur with a single consultant. The peer evaluators share a common approach and work collectively. | 4.59 | |
| 14 | Increased responsibility and autonomy | 4.57 | 6 |
| 15 | Initiated talks about possible future developments and strategic goals | 4.55 | 7 |
| 15 | Encouraged MAAP to consider certain education activities being done by other co-IAMU members | 4.55 | |
| 17 | Provided a new system of evaluation and standards common with other co-IAMU member | 4.50 | 8 |
| 18 | Helped peers resolve internal professional disagreements | 4.45 | 9 |
| 18 | Provided an avenue to bring education and information to MAAP faculty and administrative participants | 4.45 | |
| 20 | Ensured objective measurement of KPI level (high or low) for future success of the organization | 4.41 | 10 |
| Composite | | 4.60 | |

Specifically, the respondents provided the highest mean rating of 4.82 on PAESP visit: providing a venue for MAAP to share its best practices and initiatives. The other top benefits include the provision of information on areas of potential improvement, best practices, or alternatives that will enhance MAAP operation; and confirmation that the MAAP documents prepared for PACUCOA Level 3 Accreditation indicate that MAAP system is at par with International standards and best practices. These are followed by PAES-P visit having provided an objective assessment of MAAP programs and operations and supported MAAP’s external peer evaluation or benchmarking.

On the other hand, three (3) out of the twenty (20) benefit statements obtained the lowest mean ratings as reflected in Table 1. The statement helping peers resolve internal disagreements have been identified by only one at MAAP - the MAAP coordinator who is the member of the PAES-P team who cited this as one of the benefits. The other two statement benefits that were ranked lowest pertain to KPI or key performance indicators and on information and education. These findings could indicate that the respondents who rated this as the least have not participated in any IAMU training workshop on KPIs or have not read the various information materials or PAES forms provided by the PAES-P team. An indicator, that training or seminar about PAES prior to its implementation would be beneficial. Further, the above 20 statements were categorized into eight significant benefits, and the MAAP communities were also requested to rank them. **Table 2** reveals the ranking of the respondents on the considerable benefits of PAESP visit for the Academy.

Table 2. Rank of Major Benefits of PAESP Project Implementation

| Major Benefits of PAESP Project Implementation | Rank | Final Rank |
|----------------------------------------------------------|------|------------|
| 1. Promotes Communication/ Collaboration and Cooperation | 1 | 1 |
| 2. Improves Effectiveness/ Efficiency | 2 | 2 |
| 3. Provides Proofs/Validation/Confirmation | 2 | |
| 4. Objectivity/ Independence / Neutrality | 2 | |
| 5. Educates and trains | 5 | 3 |
| 6. Demonstrates Responsibility/ Duty /Concern | 6 | 4 |
| 7. Presents a Balanced View/ Sensible or Well-Adjusted | 7 | 5 |
| 8. Ensures Accountability/ Answerability | 8 | 6 |

As evident in **Table 2**, promoting communication, collaboration, and cooperation or Unity topped the significant benefits of PAESP project implementation as perceived by the respondents. The next considerable benefits include improving Effectiveness/Efficiency, provision of Proofs, validation and confirmation, and objectivity, independence, and neutrality. On the contrary, as listed in **Table 2**, the least perceived benefits include ensuring

Accountability/ Answerability and then presenting Support sensibly/ balanced view. The analysis of MAAP community perceptions revealed eight (8) general benefits that were extracted from the twenty (20) statements of benefits of the PAESP project implementation. The results both support and confirmed previous PAESP reports but this MAAP study had given a more detailed picture of the benefits of the PAES implementation. The general dimensions of benefits found were: *Information; Accountability/Assurance; Motivation; Unity; Proofs/Objectivity; Assistance; Effectiveness/Efficiency* and *Sensible Support/Balanced View*. Whereas the perceived Problems or challenges include: change in schedules and specific additional cost and workloads.

The practical implications of these findings are further analyzed and discussed below. The PAESP project having been appropriately implemented had offered the following benefits which can be summarized into eight benefits and is abbreviated as **IAMU-PAES- P** for easy recall with the last **-P** as the perceived problems or challenges.

I –Information (Educates or Trains) - External expertise is an avenue that had brought education and information to MAAP faculty and administrative participants. The dialogue and discussions were opportunities to identify and at times enlightened misunderstandings or misperceptions about the organization or administration. External peers had encouraged the international transfer of knowledge and competencies while taking into account local culture, tradition and social and economic environment. International peers shared a lot of reading materials on key performance indicators and concepts on strategic management in a university set-up. Moreover, the PAES-P team had facilitated a one-day seminar –workshop for MAAP and selected HEIs in the country that was organized by MARINA on Oct 27, 2017. Indeed MAAP community has been informed and inspired with the visit of the IAMU-PAES-P as it increased awareness of new techniques and more significant insights into thinking.

A - Accountability/ Autonomy /Authenticity and Assurance- Faculty and administrators gained assurance that MAAP sponsored programs are performing at peak efficiency to meet stakeholder needs as it also provided all concerned, the opportunity to demonstrate their respective duties, responsibilities or accountability during the visit. MAAP always welcome external assessment or evaluations as it is the only time that MAAP being accountable for its actions, can present and share its best practices and initiatives and at the same time be assured that MAAP is on the right track.

M- Motivation- All concerned were motivated, inspired and duty-bound to strive for a more advanced and more in-depth understanding of its processes; more profound approach to quality system and possibly consider specific education activities being done by co-IAMU members. The action motivated collegiality and open-minded discussions among management, staff members, students and peers for possible improvements in the organization. Indeed, motivation regarding continuing self-evaluation and reflection that promotes ongoing responsibility, innovative approach and had encouraged professional growth in areas of institutional interest.

U- Unity or Teamwork -The PAES implementation at MAAP promoted 3 Cs (*“communication, collaboration, and cooperation”*–which is the MAAP slogan for 2018) as it brought all concerned together in strengthening cross-institutional dialogue on core administrative functions. Teamwork, flexibility, and involvement of all concerned in MAAP process were enhanced.

P- Proofs/Validation/Objectivity-The external experts, who are newly exposed to MAAP as a new institution, had recognized its strengths, weaknesses, and ways to improve the institution, which may have been overlooked by those working within the system. They had provided more breadth and depth of expertise to the analysis than that available within the internal evaluator's pool, resulting in a more effective and meaningful review. They had been more open, frank, and challenging to the MAAP status quo in their comments than internal reviewers, who may feel constrained by organizational concerns.

Objective assessments of MAAP sponsored programs operations, as well as the constructive critiques, were provided and aimed to yield a better product or program. Institutional history can develop misconceptions that impact current operations or strategic goals. The external peer evaluation by experts in the field brings objectivity to the recommendations offered to assist the institution in responding to these misconceptions. MAAP documents prepared for the other accreditation bodies have been confirmed, proving that MAAP system is at par with international standards and best practices.

A-Assistance - Having met and gained new friends who are experts from IAMU, provoked a change in attitude as they also directly or indirectly helped resolve internal disagreements. All concerned were provided the confidence that in case of questions or need for advice or assistance, MAAP can count on them for a systematic approach to identification of activities that may be improved, methods to decide on and actions leading to identified goals as well as verification process.

E- Effectiveness/ Efficiency- MAAP embraces peer evaluation both institutional and external (CHED, PACUCOA, MARINA, PSB, OPIT), DNV-GL, etc.). The Implementing external peer evaluation by the co-IAMU members from Europe provided a fresh new evaluation and expectations for all units and operations. Information on areas of potential improvement, best practices, or alternatives that will enhance MAAP operation, were provided as the external peers brought a lot of their international experiences. Planning skills were enhanced to ensure more effective task management.

S- Sensible Scorecard / Support well-balanced - The PAES-P Team brings combined expertise across all areas of administration, unlikely to occur with a single consultant. The peer evaluators share a standard approach and work collectively to provide the most reasonable and sensible recommendations to MAAP. IAMU-PAESP has also presented an external score card or measurement of KPI level (high or low) for the future success of the MAAP organization. MAAP experiments with new approaches that will move them to a higher level of performance which were supported thru this PAESP project. The peer assessment activities were supported by detailed and explicit criteria and standards in the form of scores that were rated with no bias depending on the current situation at MAAP.

P- Problems or Challenges Perceived- With the above benefits come the perceived challenges. Considering that the site visit lasted for three days, the only problem experienced was the changes or interruption in the regular schedule or activities by all concerned to fit into the program of the external peer evaluators. Likewise, specific additional cost or workloads were shared by interested management, selected evaluators, heads of the departments and staff members. Nevertheless, the benefits and joy gained from this exercise had beaten the challenges.

From MAAP Students Perspective

Students (N=20) who took part in the PAES-P visit were identified because of their souvenir photo with the four members of the IAMU-PAESP team. The students composed of 4th classmen, 3rd classmen, and 1st classmen were randomly selected and interviewed by the IAMU-PAES-P team. There was no 2nd Classmen at that time, as all of them were on board for the shipboard training.

For this study, the same students have been interviewed about their PAES-P visit experience. They said that they had come to know about the MAAP foreign visitors only that day when they were all gathered in one room and had introduced themselves and their purpose. The students also remembered being asked, how they are being assessed at MAAP, how MAAP study call is being conducted; for them to identify the various equipment used at MAAP, and a lot more. The comments provided by the students on the PAESP visit have been noted as follows:

- 1) *Privileged as it is not always that we are called by foreign visitors for an interview*
- 2) *Proud to be part of MAAP*
- 3) *Excited to be interviewed*
- 4) *Mixed emotions including being nervous*
- 5) *Confirmation that MAAP is excellent*
- 6) *Enhanced confidence*
- 7) *It was our shore leave but glad to be at MAAP during the PAES-P visit*
- 8) *Confirmed that MAAP is the best maritime school to be visited by PAES-P*
- 9) *Honored to be called and included in the group of students called for the interview*

It can be surmised that the students' perceived benefits of the PAES-P visit, were entirely different from the MAAP community as it was more about their emotions or thoughts about its effect on them and to MAAP as their institution.

CONCLUDING REMARKS /RECOMMENDATIONS

Indeed, a **key factor** in the success of the PAES-P project implementation was the MAAP leadership and its community **receptivity** to the process. Everyone expressed appreciation for being able to access independent expert opinions on various issues. MAAP community viewed the external peer review team as valued partners and the process as collegial. That sense of partnership and collegiality was essential for the effective and efficient implementation of their recommendation, following the external peer review.

In general, MAAP is grateful to have been visited by outside experts and thought leaders in MET. Having self- evaluated the nine important areas of institutional operations with the assistance of expert peers from IAMU, had certainly provided objective feedback and guidance needed by the respective institutions to optimize and to provide the best standard of MET. In MAAP, the PAES-P experience highlighted the importance of the on-going relationship with local and international accrediting bodies such as: **PACUCOA** (*MAAP level 3 BSMT and BSMarE accredited programs*); **DNV-GL ISO 9001:2015** (*MAAP as first maritime academic institution certified under the provision of MET to the national and international shipping industry*); **PSB 100:2002 Singapore** (*MAAP provision of MET for the shipping Industry*) ; **OPITO** (MAAP as an accredited training provider) and the Japan Ministry of Land Infrastructure, Transportation and Tourism (**JMLITT**) **audit** (*MAAP graduates exempted from Japanese test for international and non -domestic seafarers*) which MAAP intends to maintain. Although the Philippines government does not universally require external peer MET evaluators at this time, this is a good best practice to possibly

consider by MARINA that would intensify quality education and training services, as everyone in MET would like to maintain. Furthermore, it is also given in any works of literature, like that of the studies of Ricky Lam in 2010 and Min in 2005, that to gain benefit from any peer-assisted evaluation schemes or projects, those involved, need **training or at least be informed** in the specific scheme or system being used. This exercise is ideal, as those involved may play an important role in developing the PAES form for its improvement, hence is able to evaluate or assessed other areas which may have been overlooked or missed. The participations reported here, which involved (N =22) group of MAAP community, had no training for measures on PAES process. Only the MAAP President, MAAP-PAES-P coordinator and the three MAAP executive staff (*QMR, Assistant VP and Dean*) who answered the PAES-P forms as per PAES guidelines have been informed about the PAES-P by the IAMU-PAES-P team. Nonetheless, the results show that MAAP community who were directly or indirectly involved in the PAESP implementation felt that they benefited from their participation. The results also present clear evidence that **training/education/information on Key performance indicators or KPIs** or other measures (*having been ranked the least perceived benefits*) might be beneficial for the success of succeeding PAES-P implementation. Trainers training on PAES-P implementation for a domino effect may be done in the Philippines by two IAMU member institutions (*JB Larson and MAAP*) that have had experienced the IAMU-PAES project.

The PAES-P project is focused on **education and data collection processes** based on nine areas, guided by external peers from IAMU, is indeed a unique process. It is recommended that an open-ended question should be included in the PAES form to cover other areas or topics which the PAES form may have missed and to provide more information about the institution's initiatives or accomplishments not found in any other MET institutions. From the MAAP experience, PAES project in the Philippines is absolutely a valuable quality improvement tool and a key to any institution long-term success.

REFERENCES

- [1] Francic, V. Askholn, J, Ljungklint, J. and Yutaka E (Feb 11, 2018), a 14-page IAMU-PAESP Report on the Site Visit to MAAP
- [2] Lam, Ricky (2010) A Peer Review Training Workshop: Coaching Students to give and Evaluate Peer Feedback in TESL Canada Journal Vol 27 No 2 Spring 2010 pp. 114 -127 Retrieved at <https://files.eric.ed.gov/fulltext/EJ924064.pdf> on Feb 14, 2018
- [3] McLeod, S. A. (2008) LIKERT Scale. Retrieved from www.simplypsychology.org/likert-scale.html on February 11, 2018
- [4] Min, H.T. (2005) Training students to become successful peer reviewers. System, 33, pp 293-308.
- [5] Savita (2017) Self -evaluation, peer-evaluation, patient satisfaction and utilization review retrieved from www.slideshare.net/MnSavita/self-evaluation-peer-evaluation on February 15, 2018
- [6] Zec, Damir (2015) IAMU Peer Assisted Self - Evaluation Scheme (PAES) Manual, University of Rijeka

To ENHANCE ENROLLMENT OF FEMALE CADETS AT MARITIME INSTITUTIONS AND TO INCREASE WOMEN SEAFARERS IN THE SHIPPING INDUSTRY

QI CHEN

Massachusetts Maritime Academy,
101 Academy Drive, Buzzards Bay, Massachusetts, USA Email:
qchen@maritime.edu web page: <https://www.maritime.edu/>

Keywords: women in maritime industry, female cadets, enrollment, maritime institutions

Abstract It has been widely agreed that it is time to enhance opportunities for women to be educated and gain experiences in the maritime sector. Taking Massachusetts Maritime Academy as a case-study, and applying school wide questionnaires and data collected over the course of about 40 years, this paper presents an analysis of what maritime institutions can do to advance opportunities for women to survive and thrive in the maritime field, and empower female cadets with the necessary skill sets to embrace a new era of technologically facilitated maritime industry. The findings suggest that post-graduation job market success of the senior female cadets will have the most important impact on future female enrollment and its projected growth rate at MMA.

1 INTRODUCTION

Shipping has a long-standing tradition of being a male dominated industry. However, it is widely agreed that now is the time to advance women's role in maritime activities and increase opportunities for women to be educated and gain experience in the maritime sector. This expansion of the available work force is particularly crucial in recent years due to the emergence and potential application of new technology, such as autonomous ships, unmanned cargo ships, etc. To achieve this goal, we must aim to fundamentally change the culture surrounding the maritime field, reduce the prejudices women encounter on a daily basis, and target the inherent social bias against women entering the industry.

Changes are quite noticeable across the maritime industry. There are increasingly more female role models for young women to look up to, including captains Tshepo Motloutsi of South Africa, Kate McCue, the first American female to captain a mega-cruise ship last year, and successful female entrepreneurs like Karin Orsel, MF Shipping Group CEO and president of WISTA International. The enrollment of female cadets in maritime institutions all over the world has been steadily increasing over the years. For instance, the Massachusetts Maritime Academy (MMA) of the USA started to recruit female cadets in 1980. In 2017, MMA had reached a record of 13.9% of female cadets enrolled in the undergraduate programs. At Dalian Maritime University of China, all seagoing majors, including navigation, started to accept

female cadets in 2015. Maritime companies have been hiring an ever-increasing number of female graduates for diversification of their workforce and the skill sets of their employees. A prime example is Bio-Gene Technology in 2017. A pharmaceutical company, Bio-Gene was initially interested in hiring one female cadet within the Marine Engineering major from MMA, but ended up hiring both female cadets recommended by the academy.

This paper presents an analysis of what maritime institutions can do to advance the opportunities for women to survive and thrive in the maritime field, and empower female cadets with skill sets to embrace the new era of technologically facilitated maritime industry. Taking MMA as a case-study, applying school wide questionnaires, and data collected over the course of about 40 years, the paper examines the exact measures a maritime institute could use to increase the enrollment of female cadets, to give female cadets the exact skills and trainings which would help them face the challenges and climb the shipping sector ladder, to prepare them culturally and socially to blend in well with their male peers in the work-place.

The paper is structured as the following: Section II describes and analyses the upward trend of female enrollment over the course of nearly forty years. Section III presents the changes brought about as a result of a more diversified campus. Section IV considers how job opportunities become the most important factor when attracting female cadets enrolled at the academy. Section IV offers a conclusion.

2 TO ENHANCE ENROLLMENT OF FEMALE CADETS

Though MMA is male-dominated institute, we could observe that in the past thirty-eight years, the enrollment of female cadets at MMA has been rising from 4% in the fall of 1980 to 14% in 2017.

Figure 1: The enrollment of female cadets from 1980 to 2017

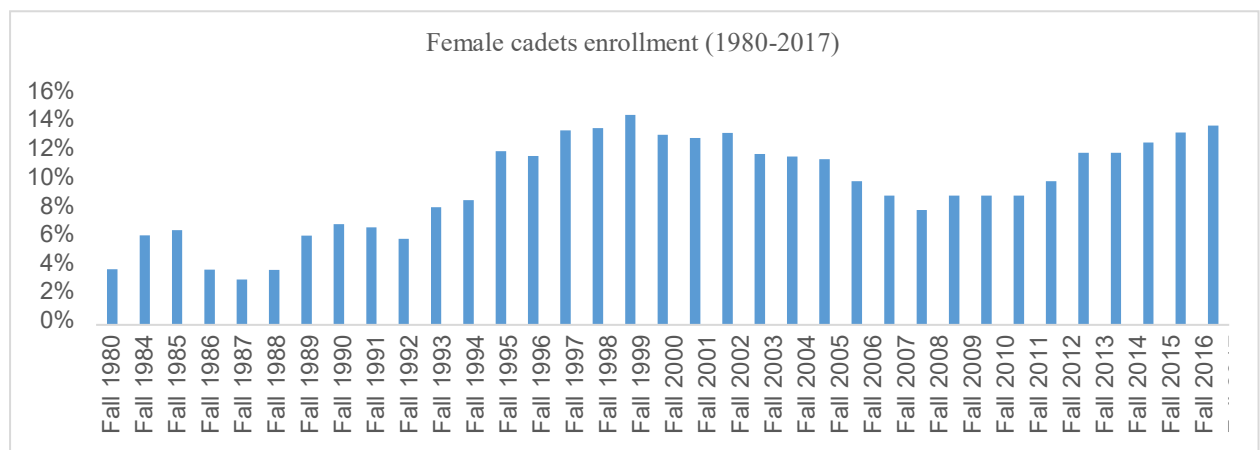

Data source: Key Data Elements & Indicators Report 2017-2018, MMA Office of Institutional Effectiveness

The graph shows the upward trend of female enrollment at MMA from 1980 to 2017, with the greatest percentage growth happened in the 1990s. Since the year 2008, we can observe a steady increase in female enrollment. Notably within the last three years, the figure indicates

the constant rising of female enrollment of 12.7% in 2015, 13.4% in 2016 and 13.9% in 2017.

The two most important reasons that explain the upward trend of female enrollment at MMA, particularly the twin peaks of late 1990' and past three years, should be the expansion of non-licensed majors for maritime education and constantly school-wide efforts to build a more diversified campus with regards to culture, gender and race.

2.1 Expansion of academic majors

The establishment of non-seagoing, majors, such as Marine Safety & Environment Protection (MSEP), should be given due credit for their role in the rising female enrollment.

Since the founding of MMA in 1891, the academy has been focusing on the licensed majors, such as Marine Transportation (MT) and Marine Engineering (ME). To tackle the problem of slow-down of business growth rate in USA in the late 1980' and early 1990', the academy developed the first non-licensed major of Facilities Engineering (FE) and began enrolling cadets in 1989. And starting from 1991, the academy began to enroll more non-seagoing majors such as Marine Safety & Environment Protection (MSEP) in 1991, International Maritime Business (IMB) in 2000, Emergency Management (EM) in 2005, and Energy Systems Engineering (ESE) in 2012.

The data in Table 1 indicates that the non-sea-going majors such MSEP, EM and IMB, have recruited the highest percentage of female cadets against the total number of cadets. Though only the data of 2017 was presented here, it is a good indication for the distribution of female cadets by majors at MMA.

Table 1. Enrollment by Primary Academic Program and Gender: Fall 2017

| Program & the year started | Male cadets | Female cadets | % Female |
|-----------------------------------------------|-------------|---------------|----------|
| Marine Transportation (1948) | 260 | 33 | 11% |
| Marine Engineering (1948) | 376 | 32 | 8% |
| Facilities Engineering (1989) | 226 | 12 | 5% |
| Marine Safety & Environment Protection (1991) | 110 | 56 | 34% |
| International Maritime Business (2000) | 202 | 23 | 10% |
| Emergency Management (2005) | 195 | 28 | 13% |
| Energy System Engineering (2012) | 66 | 8 | 11% |

Source: Data from Academic Dean's Office

The female cadets see the non-sea-going majors as wonderful opportunities for them to balance the call for open ocean and traditional feminist role, as they could work at the maritime sector ashore. One MSEP female cadet explained, "to work at a shipyard as a manager, it is a dream come true, I could be in the maritime area and at the same time have a good family life".

On the other hand, the constant emergence of automation and digitalization also offers new kinds of operational jobs which are, on many occasions, shore-based. Just as KD Adamson, CEO of Futureautics Group, pointed out, "The digital transformation of shipping will see it become part of larger intelligent mobility ecosystems, and that will create a variety of highly-skilled roles which have nothing to do with the sea. That's a big opportunity for women to join maritime and that opens the industry up for qualified women".

2.2. Role model effect

MMA is the only fully regimented maritime academy in US, unlike other maritime institutions that only apply the regimented lifestyle to licensed majors. Therefore, it might impose some concerns, or even misperceptions on female applicants for the academy, since they must go through the same rigorous military rules and training as their male peers, as well as the heavy academic requirement. By so-doing, female cadets risk giving up some of their femininity. One colleague recalled her experience as a cadet here in 1980s, “We have to wear uniforms, and we couldn’t wear the beautiful dresses and gowns, we couldn’t style our hair the way we choose. We did not feel appealing, especially in comparison to the girlfriends of male cadets.” However, when potential female applicants have family members, for example, a father or older brother who came to MMA before, it greatly helps in clearing up misperceptions about the academy and its regimental lifestyle. It is very evident in the June 2018 survey that a great majority of female cadets enrolled in MMA came to know the school through trusted sources including family members, relatives, teachers, and friends. This suggests that female students regard MMA much more enthusiastically as a viable prospect if they are educated about what to expect by a knowledgeable source.

Once female cadets did enroll, they tended to work even harder than their male counterparts. The previous department chair said, having observed over his 30 years teaching at MMA, “Female cadets tend to be more persistent, hardworking and motivated. Under male-dominated areas like maritime, they would push harder to succeed, and show their male counterparts that they can be productive and successful. Male cadets are less attentive. I would rather teach an all-female class.”

The survey I conducted in June 2018 has the sample size of 61 current cadets majoring in all programs except Business at MMA. Seven of them are female cadets and represent 13% of the sample, comparable to the overall female percentage of the student population at the academy. The answers to the question, “Sources from which you came to know MMA?” are summed up in the following table.

Table 2: Sources cadets know about MMA – survey conducted in June 2018

| Survey | Family | friend | Teacher/ counselor | MMA Cadets | Sport camp | Campus visit | MMA website | MMA in news | others |
|--------|--------|--------|-----------------------|---------------|---------------|-----------------|----------------|----------------|--------|
| Total | 54% | 59% | 8% | 21% | 3% | 30% | 15% | 5% | 8% |
| Female | 29% | 57% | 0% | 43% | 0% | 14% | 0% | 0% | 0% |

Given the facts, the surveyed students could choose multiple options, thus we can only offer approximate conclusions of the determining sources. The data shows that the great majority of cadets, both male and female, got to know the academy through their trusted sources: family members, friends, and MMA cadets. This is particularly true for female cadets. Regimental life and maritime profession seems relatively mysterious and daunting for many female high school students. However, if they had access to firsthand information about the academy through their family and friends who had been to the institute, and understood the big picture advantage of going through the education and training, female cadets might very well feel that draw between the academy and other pursuit of a college education and career path. The survey

results coincide with the questionnaires conducted by Professor Maleki and Professor Stephens of Engineering Department for their report “A Study on the Gender Gap in Engineering in 2017”. According to their two surveys, with sample size of 115 and 36 female cadets respectively, the responses to the question, “How did you come to know of MMA?”, more than 90% of female cadets in their first survey and more than 70% in the second chose to enroll in MMA through the recommendation of someone they knew and trusted.

3 TO BUILD A MORE DIVERSIFIED STUDENT BODY

3.1 To set up international programs

For ten years, MMA has been facilitating a student exchange program with Shanghai Maritime University (SMU) of China and expanded this program to Dalian Maritime University (DMU) in 2013. The exchange students need to survive the culture shock, overcome language barriers, and adapt successfully to a new challenging environment. Presently the exchange program has become increasingly popular at MMA. The participating students, who have been “gold gilded” in China, tend to stand out in the job market upon graduation, especially in comparison to their peers who have not participated in the international program.

Table 3. Participation number of MMA cadets in the MMA-SMU/DMU exchange program 2010-2018¹

| | 2010 | 2011 | 2012 | 2013 | 2014 | 2015 | 2016 | 2017 | 2018 |
|---------------|------|-------|-------|-------|-------|------|-------|------|-------|
| Female cadets | 1 | 2 | 2 | 6 | 7 | 3 | 3 | 2 | 5 |
| Total | 11 | 16 | 17 | 27 | 23 | 25 | 22 | 17 | 16 |
| % of females | 9% | 12.5% | 11.8% | 22.2% | 30.4% | 12% | 13.6% | 12% | 31.2% |

¹ Starting from the Spring term of 2013, MMA began to send five cadets over to Dalian Maritime University (DMU) of China and receive the equal amount of DMU cadets each year.

Data sources: MMA Office of Multinational Affairs

Table 3 shows clearly that female cadets composited a large fraction of students participating in the international exchange program. Looking at the available data, it is obvious that the female exchange students are given an edge over their peers. In regards to international experience that can easily be applied to future jobs, cadets who choose to take this opportunity find themselves much better candidates within a rapidly expanding job market. When combined with the females’ outstanding qualities, such as statistically higher grades, language proficiency, cultural adaptability, flexibility, genuine curiosity and persistence, it becomes an invaluable tool to help them stand out within the male-dominated field and gain, what Schneider and Barsoux (1997) refer to, the capacity to operate “across national borders somewhat like James Bond”.

Table 4. Participation number of SMU/DMU cadets in the MMA-SMU/DMU exchange program 2009-2018

| | 2009 | 2010 | 2011 | 2012 | 2013 | 2014 | 2015 | 2016 | 2017 | 2018 |
|---------------|------|------|------|------|------|------|------|-------|-------|-------|
| Female cadets | 3 | 3 | 5 | 2 | 8 | 10 | 13 | 10 | 14 | 16 |
| Total | 10 | 10 | 15 | 20 | 23 | 21 | 22 | 23 | 23 | 22 |
| % of females | 30% | 30% | 33% | 10% | 35% | 48% | 59% | 43.5% | 60.8% | 72.7% |

Data source: Office of Multicultural Affairs at MMA

Table 4 shows that visiting cadets from SMU/DMU of China consistently compose a large proportion of females at MMA. This certainly helps the diversification and cultural blend at MMA campus. In addition, Chinese cadets, both male and female, are diligent and focused students, just as one MMA professor of Marine Engineering said: “It is a pleasure to have the Chinese students in my class. They work so hard and get the best grades.”

3.2 Woman faculty and foreign-born/minority professors at MMA

Another very noticeable change is the increase in female faculties, female master mariners and foreign-born professors at the academy over the last 10 years.

Figure 2. Female faculty members at the MMA (2009-2017)

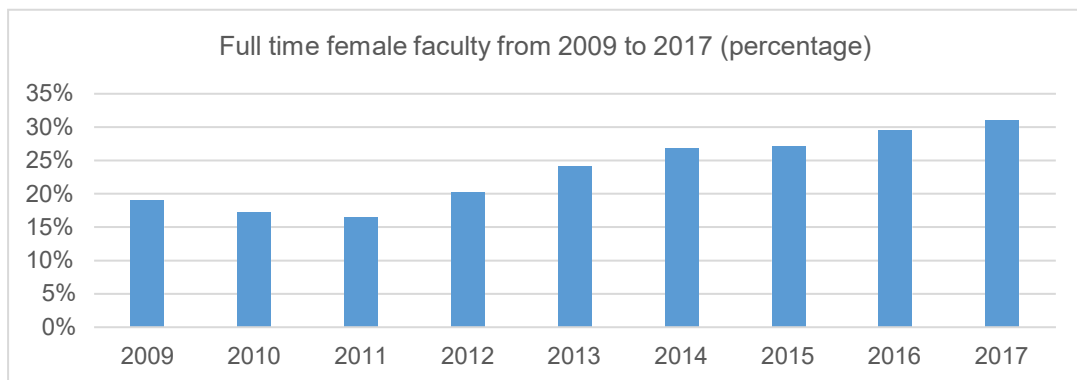

Sources: MMA Common Data Set 2017-2018

At the beginning of the fall term of 2009, MMA had 13 full time female professors, accounting for 19% of the total faculty at the academy. In 2017, the institute hired 27 out of 87 full time female faculty, reaching a historical high of 31%.

Figure 3. Percentage of full time minority faculty members at MMA 2010-2017

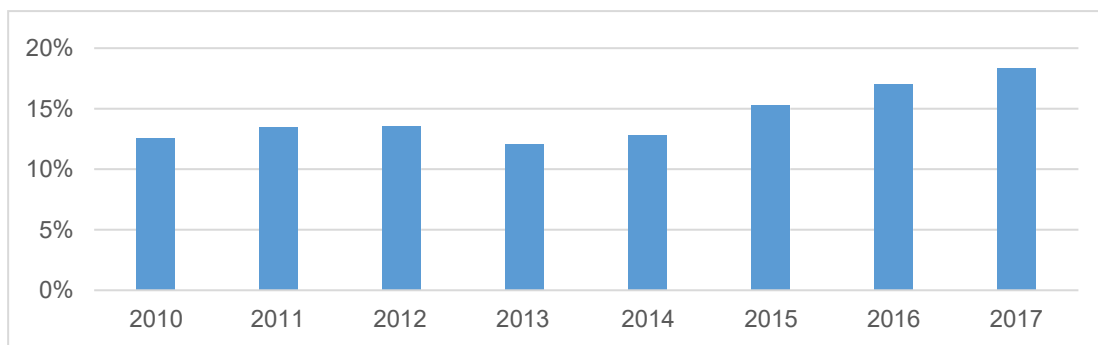

Figure 4 shows that the minority faculty members at MMA has been increasing slowly yet steadily over the past eight years. In 2010, minority faculty at MMA counted for 12.5% of total faculty. In the fall of 2017, minority professors at the academy held 18. A more race and gender diversified campus, and culturally aware maritime institution certainly helps enrollment and retention of female cadets.

4 JOB MARKET SUCCESS FOR FEMALE CADETS

Job market success for graduating cadets and their comparable salaries is sensational news that circulates the academy each year. Widespread news reports and articles in the media make the job market success of our cadets a well-known fact. The article by Jim Probasco in 2017 indicates that MMA is one of the top “27 colleges with the highest-earning graduates” in the USA, next to Harvard, MIT, Stanford, and many other prestigious institutions. According to the report, the 10-year median salary for MMA is \$69,000 in comparison to Harvard’s \$95,000. If we also take into consideration of the cost of a college education, it is no surprise that MMA was ranked #14 of Best Value Colleges nationally, #9 Best Value Public Colleges, and #2 Best Value Colleges in Massachusetts. Rankings data reflect the 20-year net return on investment (ROI) for on campus students at in-state rates with no financial aid. When 20-year net ROI is annualized, MMA is tied at #5 nationally.

In the questionnaires conducted in June 2018, cadets responded to the question, “Why do you come here?” to collect goal-orientated data.

Table 5. Factors that lead cadets decide to enroll at MMA (June 2018)

| Survey | Job opportunities | Academic | Regiment | affordable tuition | Close to home | others |
|--------|-------------------|----------|----------|--------------------|---------------|--------|
| Total | 95% | 15% | 25% | 43% | 44% | 16% |
| Female | 86% | 14% | 29% | 29% | 29% | 14% |

The survey results coincide with the responses, collected by Professors Maleki and Stephens, to the question of “Factors motivating Female Cadets to enroll at MMA”, almost 92.2% of female cadets from the first survey and 63% of the students from the second survey reported that future job opportunities was the determinant factor in their enrollment.

Table 6. Facts of 2017 graduates from MMA

| | |
|------------------------------------------------------------------|-----------|
| Career Outcome Rate (% placed) – overall | 81% |
| Career Outcome Rate by Gender (female/male) | 81% / 82% |
| Career Outcome Rate by Race/Ethnicity (student with color/white) | 81% / 82% |
| Annual full time Salary \$ 50K or higher | 79% |

Data Source: MMA Office of Placement 2018

Table 6 shows that 81% of the graduates got full time jobs on graduation and about 80% of the hired earned entry level salary of 50,000 US dollars or higher. This is quite impressive, especially considering the median household income of \$53,000 in the USA in 2017. In addition, the career outcome rate is 81%, relatively equal between male and female cadets, and among the cadets with different ethnic background. The career outcome rate, or total placement rate, of 81% could be further explained with the following table.

Table 7 Career outcome, or % of cadets get jobs by majors, March 2018

| programs | MT | ME | FE | MSEP | MB | ESE | EM | All |
|----------------------------|-----|-----|-----|------|-----|-----|-----|-----|
| Career outcome (% placed) | 71% | 74% | 91% | 96% | 86% | 83% | 92% | 81% |
| Number of cadets placed | 51 | 65 | 35 | 22 | 22 | 12 | 12 | 219 |

We can see from Table 7 that the non-licensed majors like Marine Safety & Environment Protection (MSEP) and Marine Business (MB) which enroll most of the female cadets are doing well with placement rate in recent years. This is especially observable in comparison to that of the two sea-going majors of Marine Transportation (MT) and Marine Engineering (ME). The job market success does in turn encourage greatly the enrollment of female cadets in the days to come.

IV CONCLUSION

It becomes especially useful to study thoroughly the experiences of one maritime institution, as MMA has made significant efforts to recruit more female cadets for nearly forty years, from 1980 to 2018. MMA has established a diverse school curriculum, including terms at sea for hands-on experience, internships and classes that empower young women to give them proficient skills to survive and thrive next to their male cohorts, and has given tremendous help to female cadets in securing jobs upon graduation. The successful stories drawn from the study would provide an inspiration and guide for other maritime institutions all over the world, and serve as a valuable reference for maritime companies and maritime authorities looking for valuable diversification in this age of breakneck advancements that favors adaptability.

Though for the past forty years, MMA has made tremendous progress in recruiting female cadets and building a more diversified student body, it is still far from enough. The percentage of female cadets and minority students are still at a tenuous level, and efforts to enroll more female cadets must be emphasized as a long term project with many facets affecting growth.

REFERENCES

- [1] H. Aggrey, "Women in the maritime industry: a review of female participation and their role in Maritime Education and Training in the 21st century" (2000). World Maritime University Dissertations. 383. http://commons.wmu.se/all_dissertations/383
- [2] Q. Chen, "Let number speak: job opportunities and international exchange programs for female maritime cadets", in M. Kitada, E. Williams and L. Froholdt, editors, *Maritime Women: Global Leadership*, WMU Studies in Maritime Affairs, Volume 3, pp. 129-142, Springer, 2015.
- [3] F. Maleki & G. Stephens, "A Study on the Gender Gap in Engineering (2016-2017)", Massachusetts Maritime Academy, November 2017
- [4] Payscale, 2017 College Education Return on Investment (ROI) Rankings <https://www.payscale.com/college-roi>
- [5] J. Probasco, "27 Colleges with the Highest-Earning Graduates" Investopedia, April 14, 2017
- [6] S. Schneider, & J. Barsoux, *Managing across cultures*. Hertfordshire: Prentice Hall, 1997
- [7] T. Walker, "Why we need more women in maritime industries", World Economic Forum, September 04, 2015

TRAINING ENGINEERS FOR REMOTELY OPERATED SHIPS OF THE FUTURE

GAMINI LOKUKETAGODA ^{*}, TAKASHI MIWA [†], SHANTHA G. JAYASINGHE ^{*}
AND S D RANMUTHUGALA ^{*}

^{*} National Centre for Ports and Shipping
Australian Maritime College
Locked Bag 1397
Launceston, Tasmania 7250, Australia
e-mail: Gamini.Lokuketagoda@utas.edu.au, web page: <http://www.utas.edu.au/>

[†] Graduate school of Maritime Sciences
Kobe University,
5-5-1 Fukaeminami, Higashinada
Kobe Japan
e-mail: miwa@maritime.kobe-u.ac.jp, web page: www.kobe-u.ac.jp

Keywords: Engine Room Simulator Training, Autonomous Ships, Remotely Operated Ships

Abstract. A key driver within the developments of today's maritime technology is the quest for autonomous or rather remotely operated ships. With the current pace of advancements, it is inevitable that autonomous ships will become a key driver within the shipping industry during the next 30 years. The role of marine engineers will then shift from seafarers to shore based personnel requiring new skills and expertise that are yet to be clearly defined. Therefore, the aim of this paper is to identify and discuss this emerging area from a Maritime Education and Training (MET) perspective. The paper highlights potential use of simulator-technologies and their advantages in training engineers for future autonomous ships. In addition, the paper discusses the limitations of simulator-based training approaches and new developments required within MET institutes to cater for the broader training and education needs of future autonomous ship engine room machinery operators.

1 INTRODUCTION

With the technological advancements in automation and over 40 years of experience of running unmanned machinery spaces (UMSs), modern day shipboard machinery is highly reliable with a proven capability to run in excess of 16-hours per day without human intervention. Recent developments are pushing these boundaries by initially extending this duration to a few days and ultimately paving the way to remote operations and fully autonomous ships. The indications are that remotely operated local (coastal) vessels will be in operation in the next few years, closely followed by unmanned ocean going vessels. This will have significant impacts on the nature of work in the maritime sector and the personnel who will be doing the work in the future [1].

As reported in [2], autonomous and unmanned shipping will dramatically change or in the extreme, eliminate the role of seafarers. Nevertheless, the human element is inevitable and will remain, albeit performing different functions, such as remote or shore-based operators [3, 4]. The uniqueness of training needs for such shore-based operations are recognised and the requirements for new approaches are emphasized in several studies [5]. Nevertheless, a comprehensive understanding of new skills and expertise required for such roles are yet to be clearly defined. Moreover, the approaches, technologies and facilities required to train engineers to meet the demands of future autonomous ships are not clearly understood within the Maritime Education and Training (MET) community. The current Standards of Training Certification and Watch-keeping (STCW) convention [10] and the individual national maritime training regulatory systems do not account for training needs for the future autonomous ship operators. Therefore, there is noticeable lack of understanding of the training needs and approaches for future shore-based operators, which effectively impedes MET institutes from investing in the technology and systems required to train and service to autonomous ship personnel.

The aim of this paper is to explore this emerging area from the MET perspective and highlight the use of simulator-technologies as an essential and efficient approach to train future shore based technical personnel to meet the challenges associated with autonomous ships. The opportunities and advantages of simulator-based training are highlighted in this paper with recent experiences in delivering such programmes. In addition, limitations of simulator-based training approaches and new developments required within MET institutes to cater to the broader training and education needs of future autonomous ship engine room machinery operators are also discussed.

2 ESSENTIAL FEATURES FOR REMOTELY OPERATED MACHINERY

As with the introduction of any new technology, the initial breakthrough is fraught with difficulty, until it settles into accepted routines and trends. This stage is followed by a relentless pursuit for improvements, as economic factors drive the industry to improve and expand the technology and its use. Thus, the success of remotely operated and autonomous ships depend on the: reliability of the machinery; accuracy of the associated instrumentation and control systems; and critical thinking and decision-making ability of remote operators.

The reliability of the numerous on-board machinery systems will be an essential feature for un-manned operation of ships. For example, the diesel engines with significant moving parts can be replaced with propulsion motors having only the rotor as a moving part. It is accepted

that the “electric solution” is a way forward for sea transportation in future, similar to electric trains, buses, trucks and cars for road transport. In addition to the operational flexibilities, the reduction of emissions is another motivation for moving towards electric propulsion. Thus, autonomous shipping and electric propulsion go hand-in-hand. An example is the *Yara Birkeland*, the world’s first fully electric autonomous container ship with zero emissions. The ship is scheduled to be delivered in 2019, initially running with a skeleton crew and becoming fully autonomous by 2020 [6]. Recently a Dutch company, Port Liner, commenced building Europe’s first fully electric emission free barges. The first five barges will carry 24 containers each, and will eventually become autonomous [7]. While the coastal shipping can depend on electric propulsion without fossil fuel powered generators, large ocean-going ships may need power generators to charge the batteries and/or supplying power directly to the propulsion electric motors. Although there would be preference to do so using renewable energy, in case of ships with high electrical loads, prime mover driven alternators cannot be ruled out.

When generators driven by diesel engines are employed, it introduces the additional aspect of the reliability of the prime mover and the time between overhauls (TBO) of various components. Although the TBO has increased significantly in diesel engines, liquefied natural gas driven gas turbine generators (GTG) have significantly higher TBO’s (up to 50,000 hours) [8] and will find their due place on-board ships during the autonomous transformation.

The extended operating hours of UMSs is another indicator of the reliability of machinery in modern ships. In the late seventies when the UMS ships were introduced, many were skeptical as to its future. Forty years later, majority of the ships operate in the UMS mode up to 16 hours per day. A major driver is that the shipping companies find it more productive and cost effective. Electric propulsion with less moving parts, higher and greater flexibility is another technological advancement that contributed towards extended UMS hours.

Once the machinery design and material technology requirement is achieved, the next essential feature for un-manned operation will be the accuracy and reliability of the instrumentation and the control systems associated with the various functions on board large ships. In this respect, smart connected machines, or Robotics and Autonomous Systems (RAS) are providing tools and systems to support and working alongside personnel and even work alone, making independent decisions. [9]

Finally, the human intervention or the presence of the remote operator cannot be underestimated within the operation continuum of the marine engineering function of the autonomous ship. Irrespective of the degree of automation installed on the vessel, it is yet important to enable human intervention if all else fails. On the road to transition towards fully autonomous ships, it is inevitable that technology needs to have avenues to enable humans to interface with relevant systems to mitigate unforeseen circumstances. Once the autonomous ship *Yara Birkeland* is in operation, the reality of such vessels and the required competencies of the marine engineers to remotely operate such vessels will be clearer [1].

The transition requires marine engineers who are able to remotely operate machinery from shore based stations via remote communication channels such as satellite communication. The future marine engineers will not be ‘sailing’, but may gain the required experience, i.e. virtual ‘sea time’ by operating the machinery during the ship’s voyage albeit remotely. The concept of remote operation of ships machinery from shore may pave the way for a new breed of marine engineers/remote operators. In a world with autonomous shipping, the future role of the marine engineer will essentially be confined to a shore based operating station, making

decisions based on the telemetry from the machinery managed remotely. This technology is currently used in the aviation industry and defense, where aviation and marine platforms are controlled remotely and/or allowed to operate autonomously to carry out various short and long term missions. Aspects of these operations have already made inroads into civilian applications, providing proven technology to assist the transition to autonomous ships.

Beyond the engineering challenges associated with remotely operated ships, the effective application of autonomous technology would depend upon the environment in which it is deployed. It is not just the physical maritime environment that needs to be considered, but also the business, regulatory and legal environments that all present significant challenges affecting the development and application of the technology itself [6].

3 TRAINING THE FUTURE MARINE ENGINEER

Ever since the employment of machinery for ship propulsion, engineers were required to operate, maintain and repair the main propulsion machinery and the associated auxiliary systems scattered across the vessels. The training philosophy for engineers in the past dictated apprenticeships and engineer cadet schemes with a mix of shore and ship based training. The certification of competency required appropriate duration of sea service with certain propulsion machinery and both written and oral assessments. Once qualified, the engineers at various levels of competency required further sea service and associated education/training in order to appear for further written and/or oral assessments to progress up the hierarchy.

Before investigating the issues and implications of training the future marine engineers, it is necessary to backtrack the role played by marine engineers and how they were groomed and nurtured to play that role.

As explained, the past training regime for marine engineers the common acceptance was that the marine engineer is more a ‘hands on’ person. Many chief engineers preferred engineers with hands on skills such as welding and fitting since the shipboard machinery at the time needed more maintenance and repairs than today. Besides the machinery was relatively simple compared with those of today and had very little or no automation associated with marine machinery plants. Trouble shooting did not require theoretical knowledge stemming from thermodynamics, electronics, electro-technology etc. The International Maritime Organization (IMO) convention on STCW 1978, 40 years ago effectively supported the hands on criterion by prescribing various workshop competence towards certification. Subsequently, the STCW 1995 convention, further enhanced the workshop requirement under the function “Repairs and Maintenance” in the STCW Code and its expansion through Section AIII/1 and AIII/2 [10], although the theoretical aspects are also covered in “Marine Engineering” and Electrical, Electronic and Control” functions. However, the code does not adequately focus MET institutions towards the required theoretical concepts essential to prepare engineers with the required knowledge and skills to deal with future trends and advanced technology. This situation unfortunately continues to date with many (MET) institutions and administrations not actively gearing up to face the transition to autonomous shipping that is fast approaching reality..

In a future world of autonomous ships, once the role of the marine engineer is confined to a shore based operating station away from the ship’s engine room, we find the STCW function “Repairs and Maintenance” becomes redundant to those remote technical operators. It is

however recognized that this function will yet have to be carried out at various intervals by a team of dedicated personnel. This repair and maintenance staff will be located in strategic ports and repair yards.

Further, the current function “Controlling the operation of the ship and care of the persons on-board” will be partially redundant and will need significant modifications as there will not be any persons on-board. Therefore, following competency requirements under the function “Controlling the operation of the ship and care of the persons on-board” will cease to exist once the ship becomes fully autonomous:

- 1 Operate lifesaving appliances
- 2 Apply medical first-aid on-board
- 3 Application of team working and leadership skills
- 4 Contribute to the safety of personnel

The two STCW functions “Repairs and Maintenance” and “Controlling the operation of the ship and care of the persons on-board” will diminish with the respective associated competence requirements. The remaining two functions “Marine Engineering” and “Electrical, Electronic and Control Engineering” will need modification and changes to provide the required knowledge and skills to carry out the duties as the remote operators of the autonomous ships of the future.

4 TRAINING PHILOSOPHY FOR FUTURE MARINE ENGINEERS

The fact that the modern day marine engineer is more an operator is evident from the way that technology has advanced and reduced the number of engineers in the engine room while increasing the time between overhauls of machinery. At the same time, the engineers need more of a theoretical foundation to understand the practical applications, which was not as crucial in older ships.

Hitherto the marine engineering training philosophy was to divide the theoretical and practical concepts and treat them as two separate entities. Unfortunate this continues to date, with many (MET) institutes categorising the theoretical subjects as ‘Part A’ and the practical or operational subjects as ‘Part B’. In many cases, the certificate of competency examinations also tend to separate them, with the ‘Part A’ subjects often treated as less important or relevant, although the overall curriculum requires both theoretical and practical subject knowledge. In reality, the engineers need a range of competencies in order to successfully carry out their duties. To achieve these competencies, engineers require exposure to both theory and practice. However, as there is less emphasis on Part A (the theoretical subjects), students tend to pay more attention to the learning of operational concepts, as they are perceived as more relevant and pivotal to their duties on ships and their final examinations.

The knock-on effect of the whole practice is that engineers do not see the essential connection between the theoretical foundation and the practical application. Although some find it within their ability to analyse and theorise some of it, a considerable void exists within engineers trained in such systems from grasping real situation that may hamper their critical thinking and problem solving skills. This connection is essential for the future marine engineers who are destined to operate the autonomous ships.

The Marine Accident Investigation Branch (MAIB, UK), in its reports, highlighted the separation of the theory from the application, as the cause of recent machinery failures. The

MAIB report on the catastrophic failure of harmonic filters on *RMS Queen Mary 2* in 2010 [11] states, "...it is important that the ship's engineers gain a thorough understanding of the issue of the harmonic distortion and harmonic mitigation equipment, so that they are better able to appreciate the importance of the equipment on board and take timely action if such equipment fails or deteriorates". A similar statement was issued by MAIB in the accident report on the 8500 TEU container ship *Savannah Express* with regard to its engine failure and collision at Southampton in 2005 [12]. It states, "...although the engineers on board were experienced and held appropriate STCW certificates, they were unable to correctly diagnose the reason for the engine fault at the Nab Tower and later at the Upper Swinging Ground. The increasing levels of electrification of engine control and propulsion systems require increased training requirements in the operation, maintenance and fault finding of these technically complex and multi-discipline systems. The STCW training standards for ships' engineers have not been updated to account for modern system engineering requirements". The accident also highlighted the essential need for the development of adequate type specific training.

It is evident from reports like that presented above, that when it comes to issues involving electrical, electronic, control and automation, shipboard, marine engineers are insufficiently skilled and trained. However, as on-board technology relies on electrical, electronic, control and automation, the training needs to be significantly upgraded and modernised through amendments to the STCW code and changes to the curriculum and practices. One major option is the use of simulators to develop suitable training programmes and using it as an interactive training and assessment tool. The following looks at the use of engine simulators as part of the training programme.

5 SIMULATOR-BASED APPROACH FOR TRAINING ENGINEERS FOR FUTURE AUTONOMOUS SHIPS

The effective use of simulators in engineering education has been in practice world-wide for decades. Initially the context of simulation training was restricted to applications where it was possible to prove certain engineering concepts with laboratory demonstrations. With the introduction and development of Information and Communication Technology (ICT), the capabilities of simulators in engineering education crossed the threshold of conventional simulators and entered into a new era of full mission simulations.

Simulator training has over the last few years proved an effective training methodology in training engineers, especially where an error of judgment can endanger life, environment and property. A dynamic real-time computerized simulator can compress years of experience into a few weeks, and provide knowledge of the dynamic and interactive processes typically encountered within shipboard engine rooms. Proper simulator training will reduce accidents and improve efficiency, and give the engineers the necessary experience and confidence to face crucial incidences in their job-situation. It is important that the trainees experience life-like conditions on the simulator and that the tasks they are asked to carry out are recognized as important and relevant in their job-situation. The trainees are challenged at all levels of experience in order to achieve further expertise and confidence [13].

A collaborative study between Kobe University, Japan, and Australian Maritime College, (AMC) Australia, reiterated the need to connect the theory and practical to optimize the outcomes from MET programmes [14]. For such programmes the best simulation tools are the

‘full mission’ simulators, which enable the students follow training programmes that includes:

- gaining the theoretical concepts within a class room and/or lab setting;
- observing and participating in the same concept and its application in a simulator demonstration and/or setting; and
- being assessed of the relevant competence using the simulator through appropriate and authentic assessments.

Example: Synchronising and connecting an incoming AC generator to a running generator.

1. In a classroom setting a lecturer can explain the relevant aspects of three phase alternating current. This will lead to an explanation on what parameters need to be matched between the incoming generators and the system, at what point this needs to be carried out, how it’s done and consequences of not meeting the requirements.
2. For a first or second year student this is not easy to comprehend purely through a class room explanation. With a full mission simulator exercises can be designed to allow the instructor to demonstrate this operation and the students to practice the relevant operations. This will include the starting of the generator, preparation for synchronizing, carrying out the operation, and post synchronizing tasks. The instructor can also demonstrate the consequences of incorrect operation by carrying out various tasks incorrectly. The practical interactive nature of this exercises will consolidate the learning that commenced in the classroom, with an understanding of the consequences.
3. Finally an assessment task will provide the student with the opportunity to demonstrate the competence attained, including variations. The assessor and the student clearly sees the outcome and progress, with clear avenues of feedback. This will provide the student with the confidence to carry out these tasks in real life under varying conditions.

Proper design of simulator exercises also enables the clear demonstration of the relevant theoretical concepts; for example: thermodynamics, heat transmission, electro-technology etc. can be clearly demonstrated using the ‘simulator trend groups’. This enable the students to apprehend the behavior of several dependent variables when a single independent parameter is varied. The capability of the simulator to subject the onboard machinery and plant to extreme conditions is a major advantage that usually cannot be replicated with real equipment. The very large number of possible malfunctions available to instructors can be very effectively used in simulator exercises to bridge the gap between the theory and the practical in many ways. However, care should be taken to ensure that the exercises and assessments are realistic, and that they are designed not to overwhelm the students, rather to gradually introduce and progress them through the appropriate concepts and scenarios to develop the required competence.

6 CONCLUSIONS

This paper focuses on the training requirements associated with the inevitable entry of autonomous ships. The nature of new ships and their operational modes will require new training strategies and tools in order to prepare personnel to meet the new challenges such as remote operation of these ships. The autonomous ship’s machinery will have a very high degree of reliability and an acceptable degree of redundancy to enable them to operate

without any down time. However, this will also require the remote operator to make appropriate decisions and carry them out in a timely manner.

The operators will need to be marine engineers with a strong engineering background. Given the nature of modern and future shipboard machinery and systems, they will need to have high levels of relevant theoretical and practical knowledge as the autonomous ships will be most likely to move towards electric propulsion with batteries, charging on renewable energy or power generators consuming fossil fuels. If the implementation of autonomous ships is to achieve economic benefits to shipping companies by reducing and ultimately eliminating the crew, remote operators of machinery must be capable of handling the operational and emergency situations by making appropriate and timely engineering decisions. This critical factor depends on the knowledge and skills received through appropriate training and assessment programmes. The use of engine simulators provide MET Institutions with highly appropriate technology and tools to provide such training to prepare the future workforce to operate autonomous ships.

REFERENCES

- [1] Global Marine Technology Trends 2030, Autonomous Marine Systems Lloyd's Register, QINETIQ, University of Southampton, Part 5: Smart Ships, ISBN: 978-1-5272-1347-0
- [2] Toor, A. (2015) "Could Autonomous Ships Make the Open Seas Safer?" <http://www.theverge.com/2015/10/12/9504761/rolls-royce-autonomous-unmanned-shipping-illegal>.
- [3] Hancock, P. (2017) Imposing limits on autonomous systems. *Ergonomics*. pp. 284-29.
- [4] Parasuraman and Mouloua, M., (2009) *Automation and Human Performance: Theory and applications*. Lawrence Erlbaum A, Mahwah, NJ.
- [5] Singh, A. L., Tiwari, T. and Singh. I. L. 2009. "Effects of Automation Reliability and Training on Automation-induced Complacency and Perceived Mental Workload." *Journal of the Indian Academy of Applied Psychology* 35, pp. 9–22.
- [6] <https://www.km.kongsberg.com/ks/web/nokbg0240.nsf/AllWeb/4B8113B707A50A4FC125811D00407045?OpenDocument>
- [7] The Marine Professional, the Institute of Marine Engineering, Science and Technology, Leader Electric future, Batteries, Dennis O'Neill, pp 03 Apr 2018.
- [8] The Motor ship, Could turbines turn again for cruise?, 22 Jan 2016
- [9] Lloyds Register Foundation, Foresight review of robotics and autonomous systems, Report Series: No. 2016.1
- [10] IMO, International Maritime Organization 2011, STCW 2010, ISBN 978-92-801-1528-4
- [11] Marine Accident Investigation Branch (MAIB), Report: Catastrophic failure of a capacitor in the aft harmonic filter room on RMS Queen Mary 2, Barcelona 23 Sep 2010
- [12] MAIB Report on the investigation of the engine failure of MV Savannah Express and her subsequent contact with a linkspan at Southampton docks 19th July 2005
- [13] KONGSBERG MARITIME, 2015. Training Philosophy, Philosophy of Simulation. *Product Brochure*: pp 7, Aug 2015.
- [14] Takashi M and others, Study on Reducing Communication Stress in Marine Engine Room Situation. International Symposium on Marine Engineering, 2017 Tokyo, Japan

Using SCAT Analysis to Evaluate the Effects of Sailing Vessel Training on Emotional Quotient (EQ) Competencies

YOSHIAKI KUNIEDA*, TAKUO YAMAGISHI† AND KOJI MURAI*

*Tokyo University of Marine Science and Technology (TUMSAT)
School of Marine Technology
2-1-6, Etchujima, Koto-ku, Tokyo, Japan
e-mail: ykunie0@kaiyodai.ac.jp, kmurai0@kaiyodai.ac.jp
<http://www.kaiyodai.ac.jp>

† Japan Agency of Maritime Education and Training for Seafarers (JMETS)
5-57, Kitanakadori, Naka-ku, Yokohama, Japan

Keywords: Sailing vessel training, Emotional quotient, Sailing duty training, Steps for Coding and Theorisation (SCAT)

Abstract. It is thought that sailing vessel training not only improves the knowledge and skills related to vessel operation but also has an effect in the improvement of competency relevant to emotions, such as leadership, teamwork and communications skills. The results of this study indicate that sailing vessel training can effectively improve a person's emotional quotient (EQ) competencies, which include qualities such as leadership and teamwork (2015). Moreover, the results of this study suggest that sailing vessel training is more effective than motorship training in this regard (2016). A questionnaire was developed specifically for instructors and trainees to evaluate the training program elements that influence the training effect of a sailing vessel. Since instructors and trainees generally consider sailing duties as the primary focus of this training, evaluating its relationship to EQ competencies required an evaluation of the instructors' and trainees' perceptions of sailing vessel training. In this study, perceptions of sailing vessel training, especially with respect to sailing duties, were evaluated using Steps for Coding and Theorisation (SCAT) analysis, which is a qualitative data analytical method that uses four-step coding. This paper reports the results of our SCAT analysis.

1 INTRODUCTION

Sailing vessel training has an effect in the acquisition of the knowledge and skills needed for vessel operation. Interestingly, since training and tasks are performed in a team structure, it is thought that sail training has an additional positive effect on Emotional Quotient (EQ) competencies, such as leadership and teamwork. Alison et al. reported that the effect of sailing vessel training improves positive thinking, self-confidence and a person's ability to enhance their own capability.^[1] Moreover, Inomata et al. used a COMPETENCY HIGHLIGHTER EASY AND QUICKLY (CHEQ) exam, which is a simple adoption test developed by EQ Japan. The results of this research effort indicated an improvement in EQ competency after the oversea voyage of a sailing vessel^[2]. In a related study, Kunieda et al.

found clear evidence of the training's positive effect on creativity, based on Torrance Tests of Creative Thinking taken before and after sailing vessel training (2014)^[3]. Subsequently, our previously published research showed that sailing vessel training was effective in the development of a number of EQ competencies (2015)^[4]. Moreover, we found that sailing vessel training was more effective than motorship training in this regard (2016)^[5].

Since instructors and trainees generally consider sailing duties as the primary focus of this training, evaluating its relationship to EQ competencies required an evaluation of the instructors' and trainees' perceptions of sailing vessel training. The aspects of training peculiar to sailing vessels present unique challenges for trainees, including maintenance tasks specific to sailing, such as mast painting and climbing the mast. In this study, the instructors' and trainees' perceptions of sailing vessel training, especially sailing duty, were analysed using Steps for Coding and Theorisation (SCAT) analysis, which is the qualitative data analytical technique that uses four-step coding.

2 INVESTIGATING THE ELEMENTS OF SAILING TRAINING THAT INFLUENCE THE TRAINING EFFECT ONBOARD A SAILING VESSEL

To investigate the training elements that influence the effectiveness of sailing vessel training, a questionnaire was developed and administered to 72 trainees who were near the end of their training aboard the sailing vessel Kaiwo Maru. The same questionnaire was administered to 18 training ship veteran instructors with 10 to 33 years of experience. An example of our tabulation of trainee replies to the following question is provided in Fig. 1.

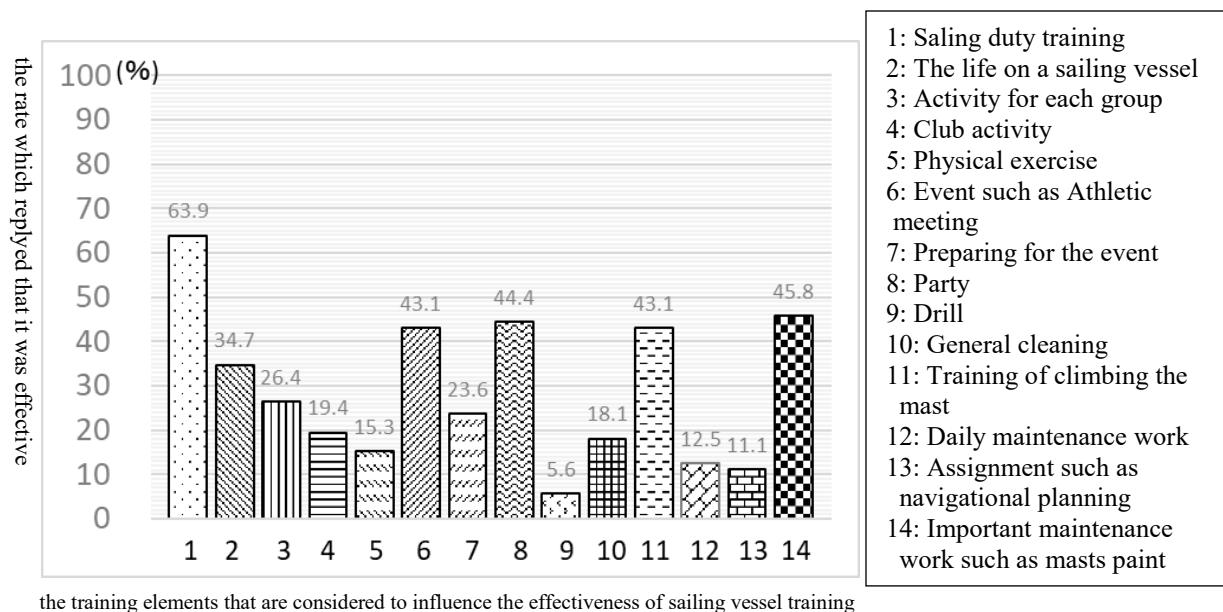

Figure 1: The result of the trainees' replies

Question: ‘Which aspects of sail training do you think have the effect of improving a trainee’s EQ competencies? (Multiple answers allowed)’

According to trainees, the most effective element of training that improved their EQ competencies was “sailing duty training”. “Training of climbing the mast” and “Important maintenance work such as masts paint”, which are peculiar to sailing vessels, were considered effective by the trainees. Although they are not peculiar to sailing vessels, “Events, such as athletic meeting” and “Preparation for the event” were also considered to be effective.

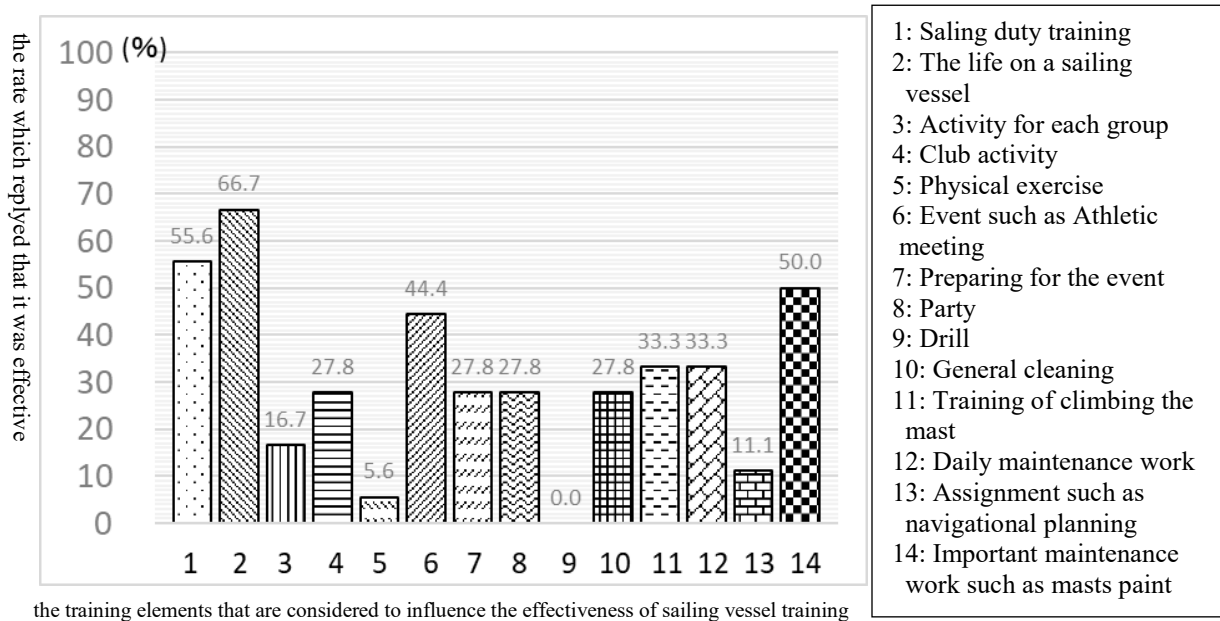

Figure 2: The result of the instructors’ replies

Fig. 2 presents the tabulated responses from the instructors’ questionnaire. Although the results here were similar to those of the trainees, instructors’ responses indicated that they had a greater appreciation for the effect that life on a sailing vessel provides. Event preparation and training of climbing the mast were considered less effective by instructors than by trainees. “Sailing duty training” is training that is only possible aboard a sailing vessel, and since sailing relies on natural wind forces, a stronger connection to nature was apparent from the results. Since sailing duty training is performed by comparatively large numbers of participants, tasks, such as look-out and steering, are important aspects in “Sailing duty training”. In addition, the angle of a sailing ship’s yards is adjusted according to wind force and direction. Moreover, setting sails and “making fast” in sailing are also performed according to changes in wind conditions. These efforts are only successful when the power of a united team is harnessed.

3 QUALITATIVE ANALYSIS BY SCAT (FOUR-STEP CODING AND THEORISATION)

Table 1: Example of qualitative analysis using SCAT
(coding of comments related to “Sailing duty training”)

| No. | Text | <1> Noteworthy words or phrases from the text | <2> paraphrased of <1> | <3> concepts from out of the text that account for <2> | <4> themes, constructs in considerations of context | <5> questions & tasks |
|----------------|---------------------------------------------------------------------------------------------------------------------------------------------------------------------------------------------------------------------------------------------------------------------------------------------------------------------------------------------------------------------------------------------------------------------------------------------------------------------------------------------------------------------------------------------------------------------------------------------------------------------------------|-------------------------------------------------------------------------------------------------------------------------------------------------------|-----------------------------------------------------------------------------------------------------------------------------|----------------------------------------------------------------------------------------------------------------------------------------------------|--------------------------------------------------------------------------------------------------------------------------------------------------------|--------------------------------------------------------------------------------------|
| 1 | Sailing under canvas pulls together all together, pulls gears, extends sails and begins to sail in response to a wind. Thereby, I realised pulling together and moving the ship rather than sailing under motor. | I realised pulling together and moving the ship | We cooperate and acquire the consciousness as a comrade and get the sense of accomplishment | We need cooperation in the sailing duty training, and we can acquire comrade consciousness and a sense of accomplishment by sailing duty training. | In sailing duty training, we have to do difficult work in cooperation. And a sense of accomplishment can be acquired. | How much is the size of a group? Is there any environmental condition difference? |
| 2 | I was impressed very much by the ability to run a ship only by the power of a wind. | I am impressed by sailing a ship by the power of a wind. | I am impressed by natural greatness. | I realise greatness of nature. | I realise power of nature and greatness of nature. | How much is the strength of a wind? |
| 3 | Since it must correspond flexibly according to a natural situation, knowledge, correspondence power and decision ability are also needed. | It corresponds to a natural situation, and knowledge, correspondence power and decision ability are required. | Power of nature grows us up. | The best for mastery of knowledge and skill concerning vessel operation and emotional ability by the power of nature. | In sailing duty training, natural greatness is felt and it can become skilled about various capabilities. | Nature changes variously. |
| 4 | It was thought that training of the sailing vessel was ultimate teaching materials which can master the knowledge as mariners, i.e. it is the seamanship. | Sailing vessel training is teaching materials which can master the seamanship. | Sailing vessel training is the best for the master of the knowledge about vessel operation, skill and emotional skills. | They are the optimal teaching materials for mastery of emotional skills by sailing vessel training. | Improvement in emotional skills other than knowledge or technology is possible at sailing duty training. | Sailing vessel is good teaching material, nature is the best teacher. |
| 5 | All crew pull together, pulled the ropes and set sails, and the sailing vessel moves by everybody's efforts. It does not work without the feeling that every person sympathises with the others of each other. | When all the crew pull together, a sailing vessel sails. It will not work, if there is no feeling of consideration for others in a sailing vessel. | The effect of cooperating is realisable in sailing vessel training. It is ideal for cherishing consideration for others. | The purpose can be achieved by cooperating in sailing duty training. And it becomes improvement in consideration for others. | In sailing duty training, a sense of accomplishment can be acquired by cooperation. Moreover, it also becomes improvement in consideration for others. | |
| Storyline | In sailing duty training, when nature is used, and a trainee is familiar and feels it as nature, a natural wonder and greatness can be known deeply. The speed of the ship which exceeds engine power only by the power of a wind is obtained, and natural greatness is realised. In order to sail under canvas, you have to do the work which all crew pull together and set sails. All crew have to cooperate in various scenes. A crew cooperates all together, faces nature and achieves the purpose of a voyage using nature. Leadership, teamwork and consideration for others can be cultivated in sailing duty training | | | | | |
| Theory writing | The trainee realised a natural wonder and greatness by carrying out a sailing under canvas. It is the power of moving a huge ship. It is the power in which man does not reach simultaneously. And it is power which man is made to consider deeply. In order to carry out a sailing under canvas, the trainee keenly realised that teamwork and communication were indispensable. | | | | | |

Given that trainees strongly indicated that “Sailing duty training” was most effective at improving their EQ competencies, qualitative analysis was conducted on trainees’ perceptions of this aspect of their training. Qualitative analysis was conducted using SCAT, which is a qualitative data analytical method that uses four-step coding. This method is a sequential and thematic qualitative analysis technique and is performed by following the procedures listed below in Table 1^[6].

<1> The first step extracts noteworthy words or phrases from the text which are related to the perception of the person responding to the questionnaire. Words connected to a research topic, words of worry or other words and phrases are written out in text form.

<2> The second step is the paraphrasing of extracted words and phrases from <1>. To accomplish this, the researcher generalises the individual phenomenon to which its attention was paid, or the description of a general concept is considered.

<3> The third step represents the perceived concept that accounts for <2>. The concept, the words and phrases and the character string which can explain <2> are developed.

<4> The fourth step is the realisation of themes and constructs that relate back to the context which are drawn from<1>~<3>. Themes and constructs related to a perceived concept are developed by considering the target text in relation to relevant surrounding text.

The questions and tasks that arise during coding are provided in an ancillary fifth step <5>, whereby an additional investigation using references may be conducted.

Thus, storylines are described from the four steps in the coding process, and a theoretical description can be developed. Table 1 presents an example of qualitative analysis using SCAT in relation to trainees’ and instructors’ perceptions of “Sailing duty training”.

4 DISCUSSIONS

“Sailing duty training” begins from setting sails. Usually, all trainees participate, and work is completed under a crew’s instruction. Trainees and crew climb the mast and go over the yards. The gasket is undone, and then, trainees and crew get down on the deck and set sails as ordered by the captain. After setting predetermined sails, the crew and trainees are expected to keep a sharp look-out on deck and with radar. Sail adjustments are made according to wind conditions, and the angle of the yard or boom is also changed. Depending on the situation, work and coordination can become quite difficult and require a high degree of training. In addition to the knowledge and skills in vessel operation acquired from “sailing vessel training”, it is thought that this training influences the improvement of a person’s emotional capability (EQ competencies).

As previously mentioned, both trainees and instructors agreed that sailing vessel training raises EQ competency. Although there was agreement on this subject, it is interesting to note that the trainees' and instructors' perceptions of the value of "life onboard a sailing vessel" were different, with the results suggesting that instructors had a greater appreciation for this aspect of sailing vessel training. Instructors' perceptions on this subject are likely influenced by their longer time involved in the experience. By contrast, trainees were relying on the experience of a single voyage, and their perceptions are better characterised as a "first impression". More specifically, trainees considered certain aspects of the training to be impressive, such as "Sailing duty training", "training of climbing the mast", "events, such as an athletic meet" and "Large-scale maintenance work such as mast painting", whereas instructors with more experience likely perceive these aspects as more of a routine.

As another point of interest, "Training of climbing the mast" is designed to give trainees the skills to climb from a low place on the vessel to a high place, with the top of the mast being the final objective. Inexperienced trainees who routinely climb the mast experience a sense of fear. It follows that, when a trainee conquers this fear and reaches the top of the mast, confidence is acquired, and the trainee can realise personal growth. Practice and repetition are essential to mastering this task, and trainees climbing together encourage each other, which is thought to improve other important EQ competencies, such as teamwork.

"Large-scale maintenance" work is the responsibility of the entire crew and the trainees, and many different forms of cooperation are required. Although a navigational officer draws up a work plan, the work is shared among the trainees and crew. This reinforces the concept of teamwork and collaboration with others. "Events, such as athletic meetings" are included with sailing vessel training to alleviate stress and ensure exposure to "fresh air", which is important on long voyages aboard these vessels because it is indispensable in the maintenance of mental stability.

As the training progresses, trainees are expected to take the lead, draft a plan and manage its implementation. More generally, trainees are taught to think, prepare in cooperation with one another and accomplish objectives by sharing responsibilities. The resulting effect on a person's EQ competency is often quite dramatic.

Using SCAT analysis, meaning and significance, which are latent in the events being analysed, can be developed and described by data. Although many conclusions can be drawn from the data collected and analysed in this study, two prominent theoretical descriptions emerged from our study efforts.

- (1) The trainee realised a sense of natural wonder and greatness by carrying out sailing under canvas. It is the power of moving a huge ship, it is the power that man does not experience in isolation, and it is the power that man feels compelled to consider more deeply.
- (2) In order to carry out sailing under canvas, the trainee keenly realised that teamwork and communication were indispensable to accomplishing goals and realising personal growth.

5 CONCLUSIONS

The results of this study indicated that “sailing duty training” has a tremendous value for both trainees and instructors. The trainees’ perceptions were analysed by SCAT analysis, and the following conclusions regarding “sailing duty training” were made:

- (1) Natural wonder and greatness, including an appreciation of the power of wind, are realised by ‘sailing duty training’.
- (2) Man’s powerlessness is felt during “sailing duty training”.
- (3) There is an effect to which deep thinking is urged in “sailing duty training”.
- (4) Trainees keenly realise the importance of teamwork and communication by “sailing duty training”.
- (5) A sense of fulfilment is realised when fear and challenges are conquered through “sailing duty training”.

Sailing duty training is the most common training conducted about sailing vessels, and many training effects were confirmed in this study. Moreover, even if certain aspects of the training are not peculiar to the training on a sailing vessel, they are extremely valuable, nonetheless. The results of this study suggest that further studies of the relationship between sailing vessel training and EQ will likely lead to important advancements in this important field of study.

REFERENCES

- [1] Dr. Allison, P. and others. The characteristics and value of the sail training experience, Report of a study conducted by the University of Edinburgh on behalf of Sail Training International, June 2007.
- [2] Inomata, K. and others. Study on the advantages of the sailing vessel training-The effect of qualification training on sailing vessel. *The Journal of National Institute for Sea Training*. August 2012, No.88, pp. 1-12.
- [3] Kunieda, Y. and others. Study on the advantages of sailing vessel training - the effect about improvement in creativity. *The Journal of National Institute for Sea Training*. August 2014, No.93, pp. 17-24.
- [4] Kunieda, Y. and others. Study on the training effect of the sail training, *International Association of Maritime Universities 16th Annual General Assembly, Proceedings*, 2015, pp. 167-172.
- [5] Kunieda, Y. and others. Study on the training effect of the sail training, *International Association of Maritime Universities 17th Annual General Assembly, Proceedings*, 2016, pp. 50-55.
- [6] Otani, T. The proposal of the qualitative data analysis technique SCAT by 4 step coding. *Bulletin of the Graduate School of Education and Human Development, Educational School, Nagoya University*, 2008, 54(2), pp. 27-44.

A SIMULATION ON TRANSPORTATION OF SUSPENDED SEDIMENT DUE TO THE MAINTENANCE DREDGING OF THE CAI LAN INTERNATIONAL CONTAINER TERMINAL, VIETNAM

NGUYEN THI THE NGUYEN ^{*}, LE THI HUONG GIANG [†]

^{*} Faculty of Coastal and Marine Engineering
Thuy loi University
175 Tay Son, Dong Da, Hanoi, Vietnam
e-mail: nguyen.n.t@tlu.edu.vn, web page: <http://www.tlu.edu.vn>

[†] Faculty of Hydraulic Engineering
Vietnam Maritime University
484 Lach Tray, Le Chan, Hai Phong, Vietnam
e-mail: gianglh.ctl@vimaru.edu.vn, web page: <http://www.vimaru.edu.vn>

Keywords: Maintenance dredging, Cai Lan, Delft3D

Abstract. Maintenance dredging of Cai Lan International Container Terminal (CICT) is expected to be undertaken every three years and generates about 50,000 m³ of dredged material. All dredged material is disposed at an offshore disposal site, which is about 42 km far from the Terminal and 20 km far from Ha Long Bay. The purpose of the study is to assess the impacts of the maintenance dredging of the CICT on the environment of the World Natural Heritage Site - Ha Long Bay. The 2D tidal current – wave, and dispersion and transportation of suspended sediment modeling were developed. The dispersion and transportation of dredged soil were simulated during dredging and after dumping. The results of the study showed that the suspended substance concentration in the core zone of Ha Long Bay was still lower than that of the Vietnamese standard. However a part of the buffer zone that was about 2-3 km far from the dredging site was locally polluted. At the dumpsite, the dumping soil did not cause any problem to the water quality of Ha Long Bay. According to the modeling results, the offshore dumpsite could be moved landwards 7 km to reduce transportation cost.

1 INTRODUCTION

Many ports throughout the world suffer from siltation of their berthing and maneuvering areas, requiring maintenance dredging activities to safeguard required depths [1]. In addition, the depths of most navigation channels gradually decrease over time due to sedimentation, since these channels behave as a sediment trap. Maintenance costs are a critical element in the

economic feasibility of a port, particularly when a relatively long access channel requires frequent dredging.

The mixing and transport of sediments (suspended load and bed load) are a function of water properties that include depth, temperature, viscosity, stratification, and salinity; sediment properties include background levels of suspended solids, material composition, density, size, particle size distribution individual grains or flocks), and solids concentration of the slurry. Hydrodynamic forces include currents, waves, turbulence, all of which cause horizontal and vertical mixing; and other influences include buoyancy (entrapped air or gas), initial momentum on entering the water body from hopper bottom [2].

One of the main concerns over dredging and dumping is the temporary increases in turbidity. Increased turbidity may also lead to short-lived effects on organisms that are light-dependent, but these are generally considered to be negligible. Dumping sediments on the seabed may smother and crush organisms living on the seafloor and may cause changes in benthic habitats and biological communities. Changes in community structure are restricted to within 5 km of the dumpsite. Continuous maintenance dredging often takes place where navigation channels to ports have high sedimentation rates, such as in estuaries. Areas that are frequently dredged have a permanently changing benthic environment. Dredging in estuaries to create a new harbor, berth or waterway, or to deepen existing facilities, can affect tidal characteristics which may affect sensitive habitats. Dredging and dumping activities also contribute to underwater noise. Therefore, it is necessary to study the sediment fate and transport mechanism (dispersion) under the action of coastal currents and waves. The investigation for locating suitable disposal site can be done by using mathematical models.

Currently, there are a number of models that can be applied to simulate the fate and the dispersion of sediment due to dredging and dumping. In a study by Shukla et al., numerical simulation of the sediment dispersion is carried out using the MIKE – 21 software for reproduction of the bed load movement of the dredged material near Karanja Creek, Mumbai, India [2]. The U.S. Army Engineer Research and Development Center (ERDC) applies the Particle Tracking Model (PTM) to quantify the fate of dredged material released during the harbor expansion project to accommodate transient nuclear powered aircraft carriers. The results of this modeling effort quantify exposure of the nearby coral reefs to turbidity and sedimentation [3]. García uses the IH-Dredge model in a dredging operation in the Port of Marin, Spain [4]. Deltares uses the Delft3D model for predicting sedimentation in navigation channels and harbour basins [1].

Delft3D is an open source, flexible, integrated modeling framework, and developed by Deltares. It can simulate two and three-dimensional flow, waves, sediment transport, morphology, water quality and ecology, and is capable of handling many of the interactions between those processes [1]. The sediment transport module includes both suspended and bed/total load transport processes, as well as morphological changes for an arbitrary number of cohesive and non-cohesive fractions. It can keep track of the bed composition to build up a stratigraphic record. The suspended load solver is connected to the 2D or 3D advection-diffusion solver of the FLOW module (density effects may be taken into account). An essential feature of this module is the dynamic feedback between the FLOW and WAVE (SWAN) modules, which allow the flows and waves to adjust to the local bathymetry changes as the simulation progresses [7].

The purpose of the study is to assess the impacts of the maintenance dredging of CICT on

the environment of the World Natural Heritage Site - Ha Long Bay. The Deflt3D-Flow model was applied to simulate the transport of suspended sediment at the dredging site and the dumpsite.

2 MATERIALS AND METHODS

2.1 Study area

CICT is located in Quang Ninh Province, Viet Nam. The Terminal fully completed its construction in February 2013. It is expected to cost \$US155 million for the first phase with the container handling capacity started from 520,000 twenty-foot equivalent unit (TEUs) in 2012, and has increased to a capacity of 1.2 million TEUs at its full capacity. CICT holds a 50-year license to develop, design, finance, construct, equip, and operate berths 2, 3 and 4 at Cai Lan Port. CICT has a 10 meter access channel draft at low tide, a 13 meter draft at the berth, a total quay length of 594 meters, and a 25 hectare container yard [5]. CICT offers shipping lines significant cost savings by enabling the deployment of larger container ships which cannot call at Hai Phong Port due to draft restrictions. This provides much needed capacity to the market, improves Vietnam's competitiveness and supports the expected growth in Vietnamese exports.

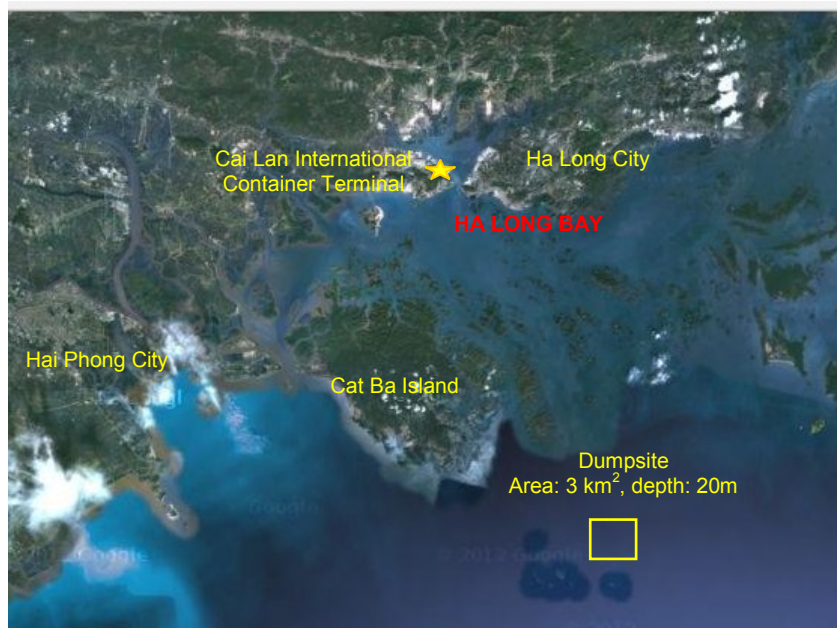

Figure 1: Locations of CICT and the dumpsite

The maintenance dredging at CICT is undertaken every three years and generates about 50,000 m³ of dredged material. All dredged material is disposed at an offshore disposal site designated by the responsible government authority. The disposal site is about 42 km from CICT, outside Ha Long Bay, and near Long Chau Island (Figure 1). The disposal site is 20 m depth and has a capacity to take 12 million m³ of deposit. CICT has characterized the chemical quality of dredged material to be disposed at the designated site to confirm that it

conforms to the allowable quality. In addition, CICT performs water quality monitoring of suspended solids, turbidity and benthic community before, during, and after dredging operations.

2.2 Suspended sediment modeling

The 2D tidal current – wave, and dispersion and transportation of suspended sediment modeling were developed for the dredging operation in CICT by applying the DELFT3D model. The dispersion and transportation of dredged soil were simulated during dredging and after dumping. Based on Ha Long Bay map, and available data on bathymetry, water level, tidal harmonic components seaward, the model area was limited as follows: 1) river limitations were at the hydrological stations at Do Nghi, Cua Cam, and Quang Phuc; 2) sea limitation was an arc that has a radius of 75km from the Terminal. Figure 2 shows the model area, and bathymetry condition. The bathymetry data at the deep sea was extracted from the DEM Etopo2 map for the East Sea. Bathymetry data near the coastline was the surveyed data. The hydrodynamic model grid had 378*483 nodes with a minimum grid size of 35 m at the dredging site and a maximum grid size of 500 m at the open sea. Landward boundary conditions were hydrological data as well as suspended sediment concentrations extracted from the observed data. Open sea boundary conditions were tidal water levels, and waves. Initial condition for suspended sediment was uniform value, which was the lowest value derived from the measured data. Wind data was also added in the simulation. To guarantee stability and accuracy of the time integration of the shallow water equations, certain time step limitations need to be taken into account. The accuracy of the model depends on the Courant-Friedrichs-Lewy number (CFL), which generally should be smaller than 10. However, in case time and spatial variations are small, the Courant number can be even higher. In this study, a time step of 60 seconds was chosen. Simulation time was set from 22/9/2016 to 6/10/2016.

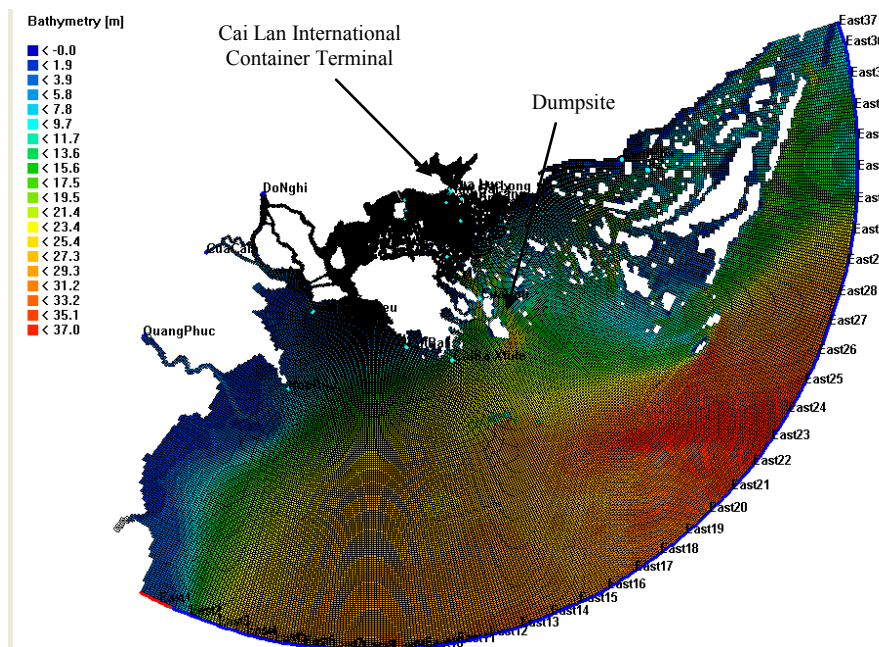

Figure 2: Bathymetry and computational grid

Source term magnitude: The source term magnitude is the amount of suspended sediment entering the environment, and is expressed as a fines flux (kg/s). The spatial and temporal variation should be accounted for through correct implementation on the computational grid. In Delft3D-FLOW, the source term is implemented as a discharge of water, and sediment. For each input cell, a discharge (m³/s) and a concentration (kg/m³) have to be specified. The source term flux is a multiplication of the input discharge by the input concentration. The maximum allowed discharge depends on the flow velocity of the ambient fluid, and the size of the computational grid. The maintenance dredging of CICT is about 40 days, leading to 50,000 m³ for the dredged soil amount, or 1,250 m³ for dumping soil everyday. Four sets of sediment samples were collected in the vicinity of the project area, and analyzed to determine their sediment size distributions. The results showed that the dredged material consisted of 65,1% sand, and 34,9% fines (23,8% silt and 11,1% clay). Based on these results, the predicted fines flux was about 6.8 kg/s (1,250 m³ of dumped soil everyday * 34,9% fines * 2,800 kg/m³) / (24 hours * 3,600s). Concentration of suspended sediment in the working center during the cutter-suction dredger's work was about 250 – 500 mg/L [6].

Model calibration is crucial part in mathematical modeling. Generally, it is done with dynamic parameters like current speed, current direction, and water levels. Available hydrological data for these processes was the surveyed water level and current data at Hon Dau station, tidal estimated data at Cat Ba, Cua Ong, and Hon Gai. The suspended sediment data for these processes was taken from the survey results in September 2016.

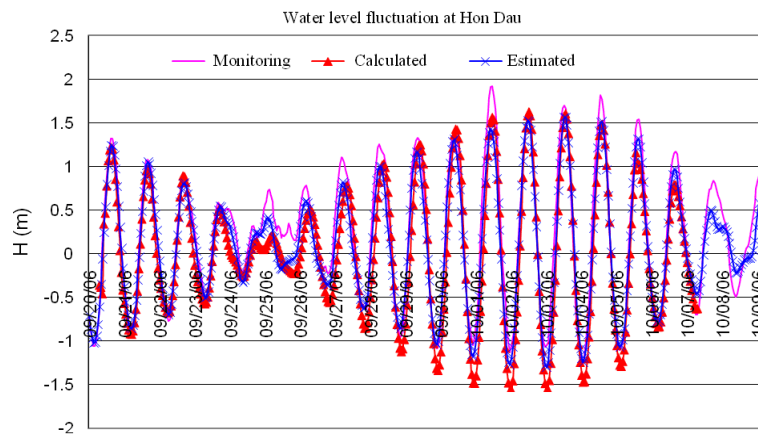

Figure 3: Calibration result on the water level at Hon Dau station

3 RESULTS AND DISCUSSION

The results of the study showed that the study area was not dominated by river flows but the tide from the sea due to its natural conditions. Therefore, the flows in this area go up and down following the tide (see figure 4 and 5). In the figures, the velocity magnitudes are positive and negative. However, the direction and magnitude of the flows in the study area significantly varied because of the complex geometry with the available of many small islands. At the dumpsite, the flow had northeast - southwest direction with the maximum velocity of 0.25 m/s (Figure 4). With this flow direction, suspended sediment was transported from the dredging site to Bai Chay Beach, and then to Ha Long Bay. Contrary to the flows

nearby the coast, at the dumpsite, the flow velocities were rather high. A maximum velocity at this location reached 0.45 m/s with north – western north direction.

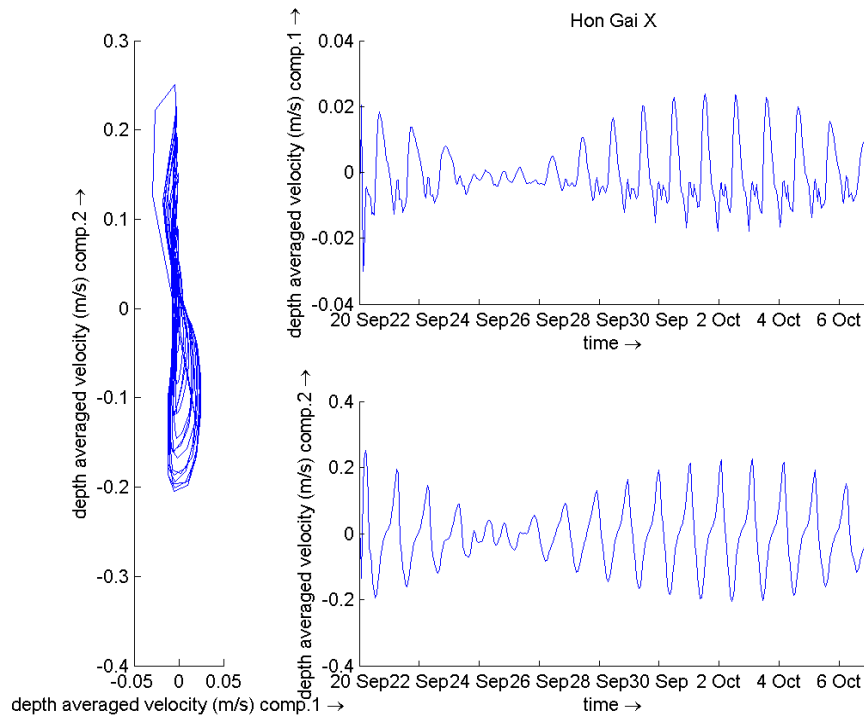

Figure 4: Flow directions and magnitudes at dredging site

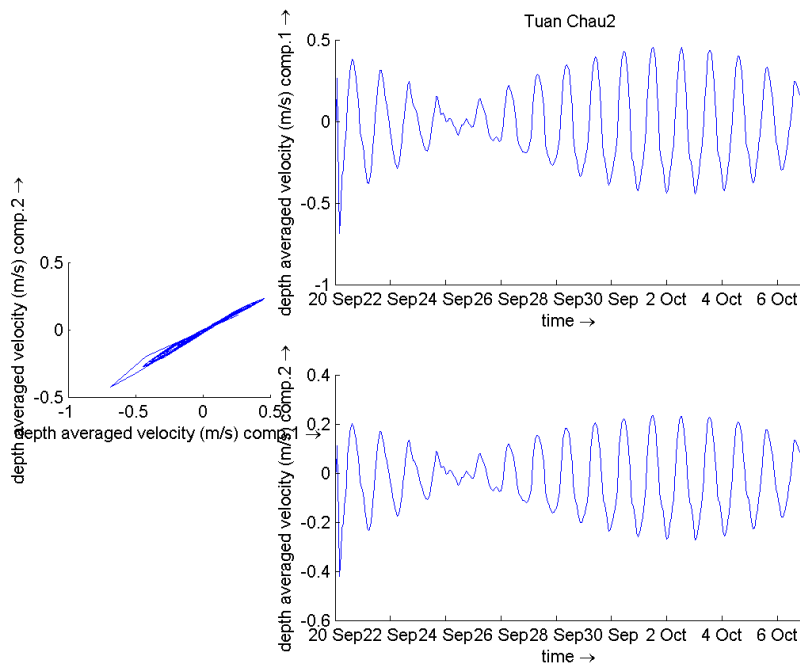

Figure 5: Flow directions and magnitudes at dumpsite

At the dredging site, the dispersion of suspended sediment changed with the tidal flow (Figure 6). The result showed the area of increase high suspended sediment concentration was less during the ebb tide than that during the flood tide. During the ebb tide, the tidal current brought the suspended sediment to Ha Long Bay. For this reason, a part of the buffer zone of Ha Long Bay, where was about 2 - 3 km far from the dredging site, was locally polluted. However, the suspended substance concentration in the core zone of Ha Long Bay was about 10 mg/L, and much lower than that of the Vietnamese standard for marine water quality (50 mg/L). During the food tide, the tidal current pushed the suspended sediment back to Cua Luc Bay. Therefore, the maintenance dredging of CICT polluted the Cua Luc Bay. It took a month for the suspended substance concentration to go back to the initial state after the dredging finishes. Most of the time, Bai Chay Beach was polluted by the suspended sediment from the dredging operation.

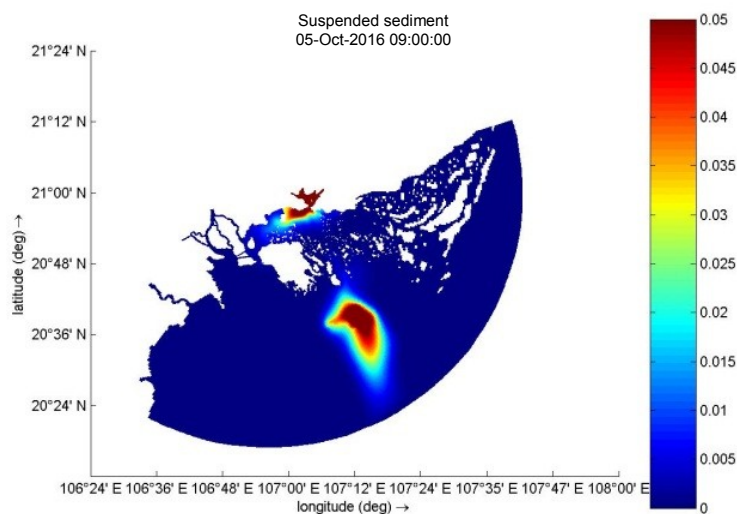

Figure 6: The distribution of suspended sediment concentration (kg/m^3) at the dredging site and the dumpsite during the food tide

At the dumpsite, the suspended substance concentration was higher than the Vietnamese limitation for marine water quality. The dispersion of the suspended sediment also varied with the tidal flow, which is showed as the changing shape in the isoclines of the increased suspended sediment concentration in Figure 7. For example, when the dredged soil is dumped in the flood tide, the largest area of above 50 mg/L concentration of suspended sediment is 8 km^2 . Under the influence of the flood tide, the suspended sediment was pushed toward Bai Tu Long Bay, instead of going into Ha Long Bay. In the ebb tide, the suspended sediment transports toward Hai Phong City. The largest area of above 50 mg/L concentration of suspended sediment is 10 km^2 . The dump of dredged material did not cause any problem to the water quality of Ha Long Bay. According to the modeling results, the offshore dumpsite could be moved 7 km landwards to decrease the transportation cost.

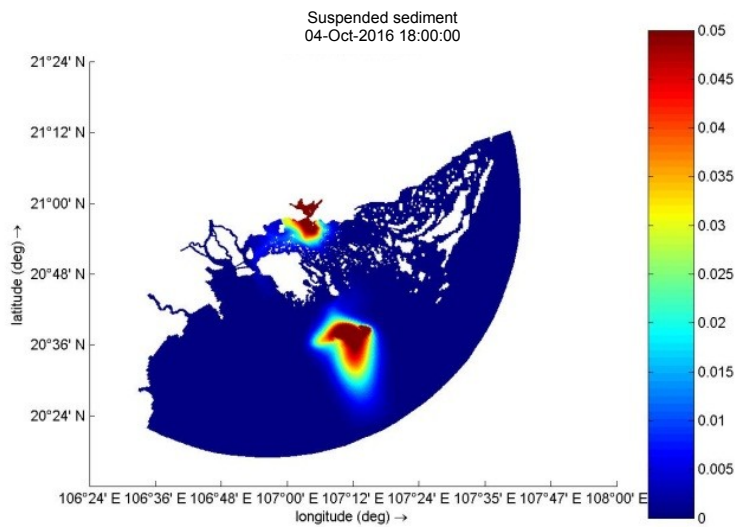

Figure 7: The distribution of suspended sediment concentration (kg/m^3) at the dredging site and the dumpsite during the ebb tide (right).

4 CONCLUSIONS

The hydrodynamics simulations indicated that the peak tidal current in the vicinity of the dredging site was in of 0.25 m/s, which may help in the dispersion of the dredged material comprising of clay and very fine silt. The maintenance dredging of the CICT did not affect the water quality in the core area of Ha Long Bay, but caused water pollution to Cua Luc Bay, Bai Chay Beach, and a part of the buffer zone of Ha Long Bay. The time required to restore the ambient conditions after the dumping ceases would be about a month. The dumpsite could be moved about 7 km landwards in order to reduce the transportation cost.

REFERENCES

- [1] Deltares. Sedimentation in Channels and Ports. The Netherlands: Deltares, 2001.
- [2] Shukla, V. K. and others. Dredged Material Dumping Site Selection Using Mathematical Models. In: *Proceedings 8th International Conference on Asian and Pacific Coasts (APAC 2015)*. India: Elsevier Procedia, 2015, pp. 109-117.
- [3] ERDC. PTM Modeling of Dredged Suspended Sediment at Proposed Polaris Point and Ship Repair Facility CVN Berthing Sites – Apra Harbor, Guam. ERDC/CHLTR-17-16. US: The U.S. Army Engineer Research and Development Center, 2017.

- [4] García, Alba J. and others. A 3-D Model to Analyze Environmental Effects of Dredging Operations – Application to the Port of Marin, Spain. In: *Advance in Geosciences*. Germany: Copernicus GmbH, 2014, 39, 95-99.
- [5] CICT. Cai Lan International Container Terminal [online]. Vietnam: CICT, 2018. [viewed date 12 April 2018]. Available from <<https://www.cict.com.vn>>
- [6] CICT, Report on Environmental Impact Assessment due to the Dredging of Cai Lan International Container Terminal, Quang Ninh, Vietnam. Vietnam: CICT, 2011.
- [7] Nguyen, N.T.N and De Vries, M.B. Predicting Trends in Water Quality in the Coastal Zone of TT-Hue, Vietnam - An Assessment of Impacts of Rice Culture and Aquaculture. In: *Asian and Pacific Coasts 2009*. Singapore: World Scientific, 2009, 4, 148-154.

AN INVESTIGATION INTO MAKING SHIPS CLEANER AND MORE ENERGY EFFICIENT

RENÉ PIERRE GUÉRAÇAGUE^a, GERMAN DE MELO RODRÍGUEZ^{b*}, J.C. MURCIA-GONZÁLEZ^c

^aInvertone Quantum Solutions, Milá y Fontanals 136, 08205, Sabadell-Barcelona Spain.

^b Department of Science and Nautical Engineering, UPC-BarcelonaTech, NT1 Building, Pla de Palau 18, 08003, Barcelona, Spain.

[*Corresponding author. Tel.: \[\(+34\)93-4017777\]. e-mail: demelo@upc.edu](mailto:demelo@upc.edu)

Keywords: environment, combustion, diesel engines,

Abstract

“**Naval-fx**” consists of the development of a novel device (diffuser-receiver) with memory effect connected to the Internet and ready on board the ship which allows through the use of the already know quantum theory the molecular reorganization of the matter applied to marine fuels. The principles of quantum physics studied and interpreted and applied in the right way allow the establishment of an algorithmic relationship between the magnetic field information of the material (in this case the fuel) to be treated and a series of sound frequencies that are emitted from a server. It allows the aforementioned molecular reorganization of the treated matter and thereby a reduction in the emissions on board CO, CO₂, NO_x and SO_x among other advantages such as noise and vibrations reduction or longer engine life. This process has been called “Dynamization”.

The main effect (based on molecular reorganization) is based on returning to atoms and molecules their original properties (before extraction, transport, refinement, etc.) through activation as explained above of their Magnetic field information. The phenomenon of activation of the system realized through computer algorithms will allow to instantly alter the magnetic information field of an atom and molecule or particle set at any distance without any loss of power made which surpasses all the electromagnetic and chemical systems employed today.

1. THE BEGININGS OF “Naval-FX”

“**Naval-FX**” is an initiative which INVERTONE launched after the impressive results achieved following implementation of “**Motor-FX**” in automotive sector. The application of “**Motor-FX**” in cars, motorcycles, vans, buses and trucks have brought great benefits both individuals and transport companies. Without forgetting Automobile competitions and elite motorcycling.

1.1.RESULTS OF THE TESTS:

Curves analysis:

Test 1: After dynamizing, the obtained torque and power curves have considerably increased its maximum range (flat zone in the center, figure 1), which defines a more elastic engine, with less need to change gears, fact that directly represents a consumption reduction.

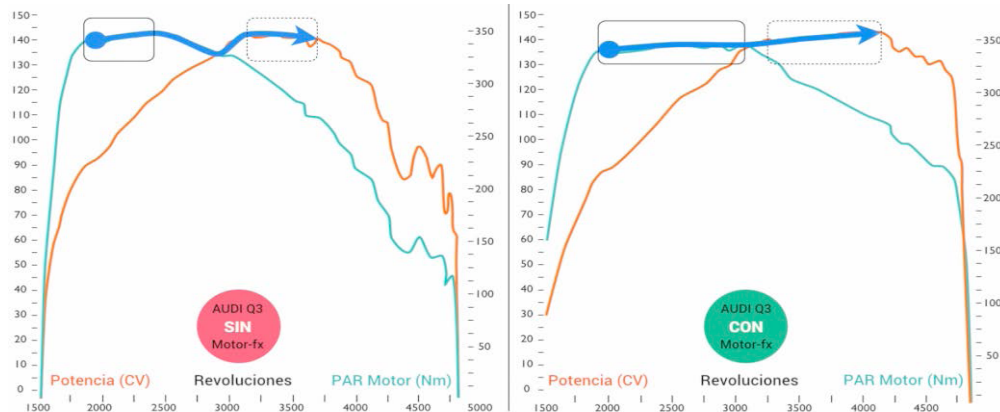

Figure 1: Test 1

Results: +54% Maximum Power Range; +104% Maximum Torque Range

Test 2 After dynamizing, the obtained torque and power curves have considerably increased its maximum range (flat zone in the center, figure 2), which defines a more elastic engine, with less need to change gears, fact that directly represents a consumption reduction.

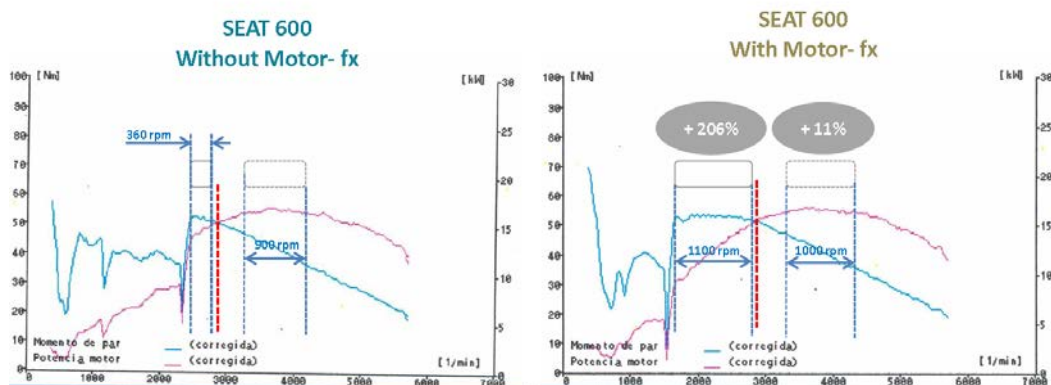

Figure 2: Test 2

Results: +206% Maximum Torque Range; +11% Maximum Power Range

1.2. EMISSION TESTING

Gas chromatography

| Vehicle | Test |
|--------------------------------------------------------------------------------------------------------------------------------------------------------------------------|------------------------------------------------------------------------------------------------------------------------------------------------------------------------------------------|
| <p>Reference: SEAT ALHAMBRA – 2012 – Diesel- 89.000km -</p> <p>Time Dynamization: Test after 42 days Dynamized</p> <p>Ambience temperature: 19°</p> | <p>Means: Gas Chromatography (CG). Test bags provided by the laboratory.</p> <p>Test Conditions: The exhaust sample is taken after starting the vehicle for 3 minutes.</p> |



Figure 3: Gas chromatography

Results: -71% of CO

OPACITY TESTS ON FOSSIL FUEL

Dynamization tests of various types of vehicles have been carried out with the following visual results:

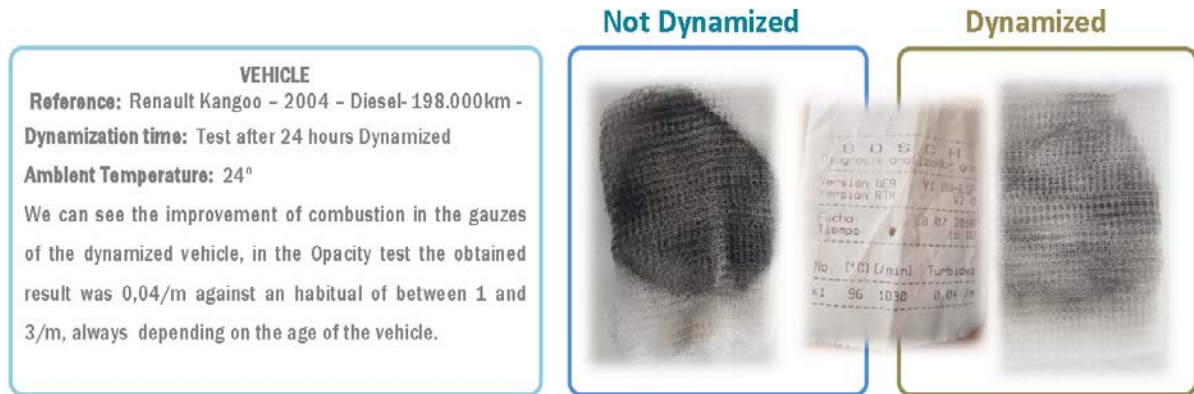

Figure 4: Opacity test

Results: -96% Opacity

2. MAIN INNOVATIVE ELEMENTS OF THE PROJECT

“Naval-FX” is a new technology that was decided to develop after 30 years of research in other areas (surgery, pests, etc.), by the engineer and physicist specializing in quantum physics René Pierre Guéraçague, on the basis of the quantum theories, principles of physics and cutting edge engineering and is born of interest in offering a complimentary response, scientific and necessarily novel to treat all those problems linked to the state of health of the human life whose origin are mainly:

1. The stressful life, under physical, moral and social pressure.
2. The electromagnetic pollution, emissions of polluting gases, noise pollution, etc.
3. The increasing biochemical incompatibility provoked by inadequate nutritive contributions.
4. The parasitic problems and bacterial (caused by the incompatibility biochemistry).

In a simple, effective and revolutionary through the provision on board the vessel of a diffuser-receptor quantum with memory effect connected to the Internet, this technology will be able to:

- Reducing the emissions of polluting gases (CO, CO₂, NO_x, SO_x and PM (Particulate Matter)).
- Diminish the Noises and Vibrations.
- Increase the useful life of the Marine Engines
- Increase the engine torque and power.

In contrast to the technologies and methods applied at present, as we have described in the previous point, this innovative technology that will develop is primarily based on the principles of quantum physics and will provide a solution:

Without the need to intervene physically in the vessel or on engines; suffice with the provision on board a receiver-diffuser with memory effect and internet connection, figure 5, whose dimensions and characteristics are similar to a modem. In case of producing a loss of sign to him, the system will remain active, thanks to its memory effect during a period of 60 days from which there will be realized a reconnection that will allow to restore and preload automatically, without the presence of any of our technicians, those future briefings that are available.

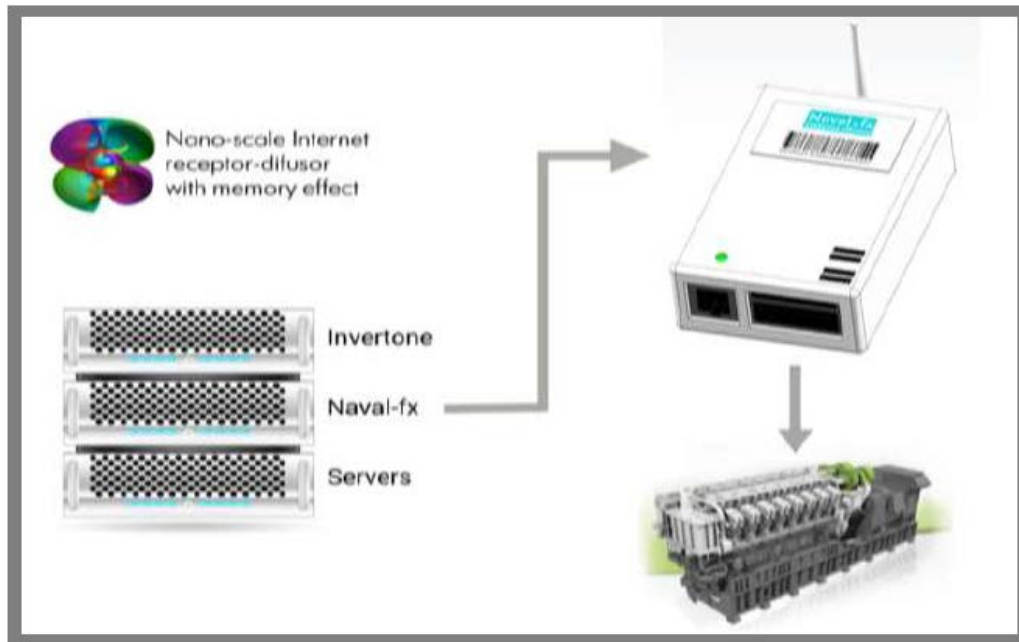

Figure 5.: Phenomenon of Investment of Frequency

- In a precise way; be already to individual way (on the matter) or for delimitation GPS, without importing the size or place of the surface to be treated.
- Without need for investments in machinery, occasionally in computer equipment.
- Without need to increase structure or hire specialized personnel.
- Without maintenance, everything is carried out through quantum servers located in our headquarters.
- Without the need to modify the internal logistics or means of storage and distribution.
- Without additional costs (energy, of personnel, transformation of the ship, etc.) to those of the contract of the service.

This innovative and efficient technology developed initially to end with one the main causers of respiratory and cardiovascular illnesses, the contamination by emission of pollutant gases, is based in:

René Pierre Guéraçague, German de Melo Rodríguez, J.C. Murcia-González

- Principle of quantum entanglement: This theory posed by Einstein, Podolsky and Rosen, describes the property that has two or more intertwined particles of sharing a same magnetic field of information.
- If one of the objects receives information, the rest of the interwoven perceive it in an instantaneous form, regardless of the space that separates them.
- Phenomenon of DNA phantom: The study carried out by Russian scientists, the doctor in Biophysics Vladimir Poponin and molecular biologist Pjotr Garjajev, on the DNA molecules, concluded in the demonstration of a characteristic effect called "DNA ghost".
- Phenomenon of investment of frequency: physics represents the frequency as a set of waves that are repeated in a period of time. Given a frequency, if you superimpose its inverse, the result is null.



Figure 6: Phenomenon of investment of frequency

3. OPERATING PRINCIPLES

From our researches, has been able to establish a relationship algorithmic between the information field magnet of the element to be dealt with and sound frequencies. From these frequencies, through our systems, are obtained their inverses, which are issued from our servers quantum.

These frequencies are effective only for the receiver element, since it is with the only one with which it has established the entanglement.

The quantum principle of interlacing makes it possible for the exchange of information between our quantum server and the receiver to be instantaneous and at any distance.

Through the "dynamized", what is achieved is a controlled rearrangement of the molecules in order to modify their biochemical properties:

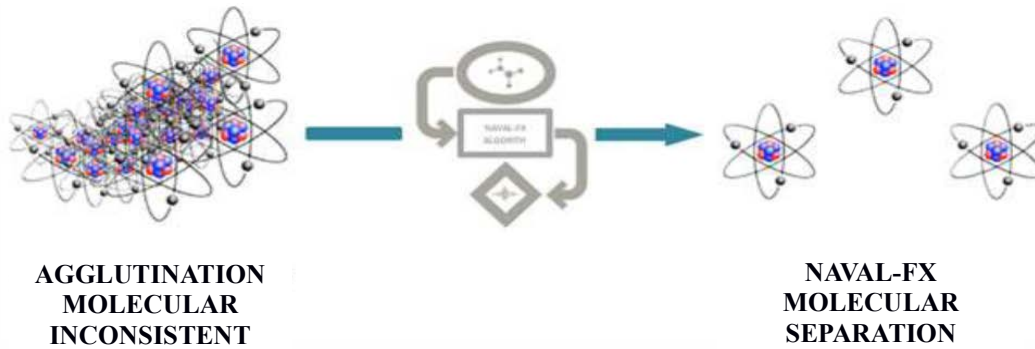

Figure 7: Naval-FX "controlled rearrangement of molecules"

4. PRINCIPLES OF APPLICATION

The ship will have to take assigned an alphanumeric code of unequivocal identification which will turn him into the only receiving surface of the information sent from the quantum servant placed in our head offices; All of this by the employment of the receiver-diffuser "NAVAL-FX" with memory effect and connection to internet, which located on board of the vessel will allow the activation molecular of the fuel and the exhaust gases from the combustion, giving rise to a molecular separation consistent that:

Will reduce the emission of polluting gases (CO, CO₂, NO_x, SO_x and MP (Particulate Matter)). From the same moment in which the activation is carried out, there will take place a progress of the energy efficiency of the fuel. All this, it is a consequence of the best combustion of the fuel that we obtain after the dynamization of the same one.

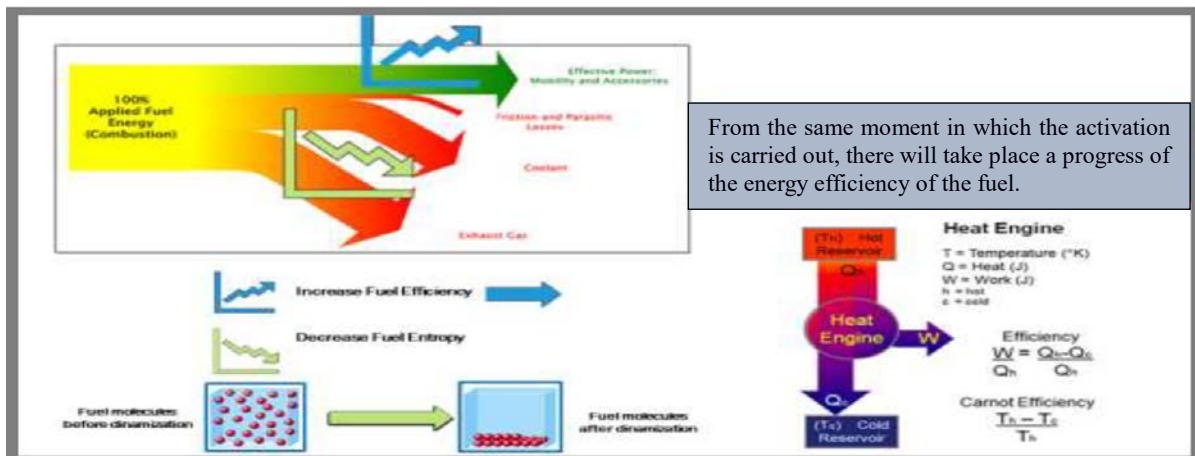

Figure 8: Naval-FX "activation Result"

Reduce Noises and Vibrations. The dynamization will optimize the fluency of the fuel, improving it the lubrication of the pieces of the engine in movement, of the transmission, etc. These improvements will provide crews and passengers on board during the navigation a greater comfort that will be reflected in the case of the onboard personnel in a better performance. In addition to be seen a decrease of the frequencies that affect the marine species, a direct consequence of the reduction of noise of narrow band (noise generated by machinery such as diesel engines of ships, generators or auxiliary machinery).

As a result of better fluidity of operation, is substantially reduces the sound level.

The propulsion engines will have a more homogeneous noise from the start of start-up if the activation is successful. After several hours stopped (engines in cold), on having produced the starter to him, the answer will have to be the same that if the above mentioned engines had finished of being stopped and a few seconds later, in hot, they would have been restarted.

The intensity of the noises and vibrations will have diminished of notable form after the dynamization giving the sensation that the above mentioned engines are better greased.

The consequence of the dynamization, it takes root in a better lubrication of the mobile parts of the engines (it diminishes the friction between the above mentioned mechanical elements), and as a result of it, we obtain a reduction in the level of noises and vibrations, as well as a better yield of the same ones.

Increase the useful life of the Marine engines on board. When there is no good combustion, as we know, it generates loss of power, increased fuel consumption, high production of polluting gases and an increased risk of damage to the motors or mobile elements that it has.

The dynamization, in this case of the fuel, will give rise to a stabilization of temperatures that improves the motor operation and decreases by direct consequence the alteration of the parts that make it up, getting longer its useful life.

Increase the torque and the power. In the naval sector and in particular with regard to the maritime traffic of goods, the optimization of costs is key to survival in the market. Therefore, when giving a step outside our borders, companies should not only consider conscientiously toward where they want to run their businesses, but also that resources need to achieve this. Then, delivery times can play against or in our favor.

As a result of the dynamization of the fuel, it produces a total combustion of the same increasing the power and the motor torque, since the whole fuel transformed in movement. With the employment of this innovative technology based principle on the beginning of the quantum physics, we might be speaking about an increase of potency of exit of helix of approximately in an environment of 8 % to 10 %.

The above information will remain active continuously acting at the sub-atomic level in the fuel molecules in that area of the engine in which the combustion phenomenon takes place and in the exhaust gases at its exit.

To proceed to the activation of the system, it will only be necessary to have a series of information that they convert to this ship into only one, and that allows that the dynamization process to be carried out over a distance, indistinctly of the place of the world in which the vessel will be.

5.-TEST ON VESSELS

Table 1: The main technical characteristics of the ship

| TYOLOGY VESSEL | YEAR OF BUILDING | L(m) | B(m) | P(m) | T _{max} (m) | EFFECTIVE POWER (kW) | MAIN ENGINES FEATURES |
|----------------|------------------|-------|-------|------|----------------------|----------------------|------------------------|
| VESSEL 1 | 2009 | 29,50 | 11,00 | 4,00 | 6.95 | 2 x 2.400 | 2 x Rolls Royce Marine |
| VESSEL 2 | 2007 | 29,50 | 11,00 | 4,00 | 6,90 | 2 x 2.400 | 2 x Rolls Royce Marine |
| VESSEL 3 | 2016 | 31,50 | 11,20 | 5,40 | 4,40 | 2 x 2.350 | 2 x Catepillar Engine |

Table 2: Emissions of exhaust gases

| OPACITY | COMMENTS | EMISSION REDUCTION (%) |
|------------------------------------|-----------------------------------|------------------------|
| Eight seconds after motor starters | Brown-Yellow smoke and less dense | 50% |
| Sailing | The smoke practically disappear | 55%-75% |

After the dynamization of the ship, the operations performed on board by the crew during their day-to-day activities have been facilitated by reducing the odors caused by the exhaust gases which were produce during combustion in more than 70% both in Engine Room as in the bridge of government.

The noise of the engine after the dynamization of the vessel is more homogeneous from the beginning of its commissioning. After 14-20 hours stopped, when the engines are started the response is the same as if those engines had run out of and a few seconds later, in hot, re-started.

Results:-75 % de Opacity

Table 3 Consumption

| YEAR BUILDING | CONSUMPTION BEFORE DYNAMIZATION (l/h) | CONSUMPTION AFTER DYNAMIZATION (l/h) | FUEL SAVINGS (l/h) | SAILING HOURS (h) (AUGUST) | AUGUST FUEL SAVINGS (l) | PRICE MDO (\$/l) | MONTH PRICE SAVING (\$/month) | YEAR SAVING (\$/year) |
|---------------|---------------------------------------|--------------------------------------|--------------------|----------------------------|-------------------------|------------------|-------------------------------|-----------------------|
| 2009 | 166,00 | 132,80 | 33,20 | 204 | 6.772 | 1,31 | 8.872 | 106.468 |
| 2007 | 225,00 | 189,90 | 35,00 | 228 | 7980 | 1,31 | 10.453 | 125.445 |
| 2016 | 244,70 | 223,00 | 21,70 | 217 | 4708 | 1,31 | 6.168 | 74.023 |

Results:15-20% Fuel Savings

REFERENCES

- [1] Corbett, J.J., Kohler, H. (2003). Updated emissions from ocean shipping. *J. Geophys. Res.* 108 (D20): 4650–4666.
- [2] Corbett, J.J., Wang, C., Firestone, J. (2007). Allocation and forecasting of the global ship emission. In: *Proceedings of the Paper presented at Clean Air Task Force and Friends at the Earth International*, Boston, MA.
- [3] Dalsoren, S.B., Eide, M.S., Endresen, O., Mjelde, A., Gravir, G., Isaksen, I.S.A. (2009). Update on emissions and environmental impacts from the international fleet of ships: the contribution from major ship types and ports. *Atmos. Chem. Phys.* 9: 2171–2194.
- [4] De Meyer, P., Maes, F., Volckaer, A. (2008). Emissions from international shipping in the Belgian part of the North Sea and the Belgian seaports. *Atmos. Environ.* 42: 196–206.
- [5] Dragovic, B., Tzannatos, E., Tselentis, V., Mestrovic, R., Skuric, M. (2015). Ship emissions and their externalities in cruise ports. *Transport. Res. Part D (in press)*.
- [6] Endresen, O., Sorgard, E., Behrens, H.L., Brett, P.O., Isaksen, I.S.A. (2007). A historical reconstruction of ships' fuel consumption and emissions. *J. Geophys. Res.* 112: D12301.
- [7] Endresen, O., Sorgard, E., Sundet, J.K., Dalsoren, S.B., Isaksen, I.S.A., Berglen, T.F., Gravir, G. (2003). Emission from international sea transportation and environmental impact. *J. Geophys. Res.* 108 (D17): 4560, D17.
- [8] ENTEC (2002). Quantification of emissions from ships associated with ship movements between ports in the European Community. UK: Report prepared for the European Commission.
- [9] Eyring, V., Koehler, H.W., van Aardenne, J., Lauer, A. (2005). Emission from International Shipping: 1. The last 50 years. *J. Geophys. Res.* 110(D17305): D17305.
- [10] IMO (2014). *Third IMO GHG Study 2014*. Micropress Printers, Suffolk, UK.

René Pierre Guéraçague, German de Melo Rodríguez, J.C. Murcia-González

- [11] Melo Rodríguez, G. de, Martín Alcalde, E., Murcia-González, J.C., Saurí, S. Evaluating air emission inventories and indicators from cruise vessels at ports, *WMU Journal of Maritime Affairs*, Volume 16, Number 3, September 2017.
- [12] McArthur, D.P., Osland, L. (2013). Ships in a city harbor: an economic valuation of atmospheric emissions. *Transport. Res. Part D* 21– 4752.
- [13] Miola, A., Ciuffo, B., Giovine, E., Marra, M. (2010). Regulating air emissions from ships: the state of the art on methodologies, technologies and policy options. European Commission, JRC reference reports.

ASSESSMENT OF MARINE DIESEL ENGINES PERFORMANCE BASED ON CARBON AND NITROGEN OXIDES CONTENT IN EXHAUST GASES

VICTOR ODINTSOV ^{*}, PAVEL KOVALISHIN [†], GLAZKOV DMITRY ^{*},
SVIRIDYUK NIKITA ^{*}

^{*}Department of Ship's Propulsion Plants
of Kaliningrad State Technical University
Baltic Fishing Fleet State Academy
Molodeznaya str., 6, 236029 Kaliningrad, Russia
e-mail: seu@bga.gazinter.net, <https://bgarf.ru>

[†]Department of the English language
of Kaliningrad State Technical University
Baltic Fishing Fleet State Academy
Molodeznaya str., 6, 236029 Kaliningrad, Russia
e-mail: seu@bga.gazinter.net, <https://bgarf.ru>

Keywords: Marine diesel engines, operating conditions, combustion dynamics indicators, carbon, nitrogen oxides, regularities

Abstract. The paper presents the analysis of the regularities of the carbon and nitrogen oxides content in the exhaust gases of marine diesel engines (MDEs) of fishing industry fleet, taking into account the features of their operation (changes of hydrometeorological conditions and technical performance). The factors cause decrease in excess air coefficient during combustion, deterioration in the quality of fuel atomization, mixture formation and combustion.

A special feature of mixture formation and combustion processes in MDEs with a volumetric method of mixture formation is the separation of the combustion chamber into a series of macro-volumes, each of which receives fuel from the corresponding nozzle opening. At the same time, the concentrations of fuel and air in terms of jets length and sections of are uneven. The smallest drops are located on the surface of fuel jets and, first of all, are inhibited in the dense and hot environment of the working fluid.

The temperature in the combustion zone reaches 2600-2900 K and warms up the fuel contained in the inner layers during the lack of oxygen. As a result, carbon is formed, and at the same time in the surface layers - nitrogen oxides.

It is shown that in order to simulate the influence of operating factors, the indicators describing the dynamics of combustion of fuel and those that explicitly take into account the effect of structural and operational factors are suitable. A difference in the regularities of the change in carbon emissions with exhaust gases for engines with supercharging and without it is focused. Dependencies have been proposed for modeling carbon emissions and nitrogen oxides when a supercharged engine is subjected to a load (regulatory) characteristic. The

possibility of using indicators for diagnosing the technical condition of internal combustion engine is shown.

1 INTRODUCTION

The engines of the fishing fleet vessels operate in different regions of the World Ocean which are specific in hydrometeorological conditions and MDE technical conditions changes. It results in decrease in the excess air factor during combustion, increased fuel consumption, carbon/ nitrogen oxides and other harmful components emissions, increased thermal stress of cylinder piston group [1].

Engines with volumetric (jet) method of mixture formation are mostly used on the vessels of the fishing industry fleet. In the case fuel jets surface contains the smallest drops which are primarily inhibited, evaporated and ignited. The flame temperatures reach 2600-2900 K [2] at which intensive formation of nitrogen oxides occurs. Approaching the axis and the front of the jet the droplet diameters increase and the amount of air that is available decreases. Consequently, under the influence of the heat flux, pyrolysis of fuel droplets with hydrogen separation and carbon formation occurs [2],[3],[4].

To assess the quality of spraying and mixing, there are several approaches. The first calculates the number and diameter of the fuel droplets, their distribution in the fuel jet. The disadvantage of this approach, in our opinion, is the excessive complexity and the absence of an indicator characterizing the surface area of the heat and mass exchange with the surrounding air charge. In the second, the ratio of the surface area of fuel jets to the amount of fuel contained in them is proposed [5]:

$$K_{p\Sigma} = F_{\phi\Sigma} / g_{\text{ц}} \quad (1)$$

where – «F» is the surface area of the fuel jets at the end of the injection process, m²; g_ц – cyclic fuel supply, kg.

This indicator is applied to both the fuel jet as a whole and its individual components.

With the deterioration of the combustion process, accompanied by an increase in its duration, the temperature of the parts of the CPG(cylinder piston group) increases significantly [6]. Therefore, under the influence of operational factors that lead to an increase in the average indicator pressure, a decrease in the excess air factor during combustion, an extension of the combustion process (and heat transfer taking into account radiation), the calorific intensity increases. Thus, we should add an increase in calorific intensity due to excessive fuel consumption (caused by increased resistance to vessel movement and the deviation of the combustion process from that one specified by the manufacturer [1]) to the known categories of hazards discovered by the scientists of the Admiral Makarov State University of Maritime and Inland Shipping [7],

One of the indicators for assessing the technical performance of the diesel engine can be the content of products of incomplete combustion and nitrogen oxides in its exhaust gases.

The purpose of this paper is to develop an integrated algorithm for estimating the overall technical performance of the engine for the content of incomplete combustion products and nitrogen oxides in the exhaust gases.

For example, [5],[8], it is established that carbon emissions depend on a set of factors including: the thermal characteristics of the fuel used, the state of the air charge in the cylinder at the time of fuel supply, the geometric characteristics of the atomizer nozzle, the characteristics of the fuel supply processes, combustion. These factors are taken into account by the following complexes, the exponents in which are obtained taking into account the work of Professor A.S. Lyshevsky [9] who investigated a large array of experimental data on the characteristics of spraying of fuel:

$$B = \left(\frac{\mu_{cn}}{\mu_{c3}} \right)^{1,42} \cdot \left(\frac{d_{cn}}{d_{c3}} \right)^{1,05} \cdot \left(\frac{P_{fin} - P_{un}}{P_{fb} - P_{u3}} \right)^{0,71} \cdot \left(\frac{\rho_{Tn}}{\rho_{T3}} \right)^{1,05} \quad (2)$$

$$\left(\frac{\sigma_3}{\sigma_n} \right)^{0,37} \left(\frac{\mu_n}{\mu_3} \right)^{0,32} \frac{P_{u3} T_{un} J_{ci} g_{u3}}{P_{un} T_{u3} J_{c3} g_{un}} ;$$

$$C = \frac{tg\gamma_n (1 / \cos\gamma_n + tg\gamma_n)}{tg\gamma_3 (1 / \cos\gamma_3 + tg\gamma_3)} \quad (3)$$

$$D = \frac{\tau_{und.n} \tau_{enp.3}}{\tau_{und.3} \tau_{enp.n}} \left(\frac{\tau_{Zn} - 0,5\tau_{enp.n}}{\tau_{Z3} - 0,5\tau_{enp.3}} \right)^{1,6} ; \quad (4)$$

where « d_c » and « J_c » – are the diameter and number of nozzle openings in the atomizer, « μ_c » – is its flow coefficient, « P_f » – is the average fuel pressure, « P_c » and « T_c » – are the mean pressure and temperature of the air charge in the cylinder during the fuel supply, « ρ », « μ » and « σ » – are the density, viscosity and coefficient of surface tension of fuel, « g_{up} » – cyclic fuel supply, « γ » – cone angle of fuel jet (torch), « τ_{ind} », « τ_{bnp} » and « τ_z » - duration of ignition delay, fuel supply and combustion respectively, for the calculation of which are designed the formula [5].

It is established that [10] for atmospheric engines, the dependence of the carbon content in the exhaust gases as a function of the product of complex indicators (BCD) is linear. For example, for an engine of 1NVD24 [10]:

$$c = -0.123 (B * C * D) + 0.1844 \quad (5)$$

where « c » - is the specific carbon emission in g/(kW*h).

However, in some high – speed internal combustion engines, for example 8-12/12 [8], in modes close to the rated one, the deviation from the linear dependence is observed due to the increase in the length of the fuel jets and part of the cyclic fuel supply to the walls of the combustion chamber.

It should be noted for supercharged engines: as the load decreases, the dependence of the form (5) also deviates from the linear one, starting from a relative load of less than 50%. For example, in the MAN D 2866 engine (6 cylinders, 4 – stroke, bore 128 mm, stroke 155 mm) installed on the sailing training ship Krusenstern as a diesel generator, the deviation of the type (5) from the linear characteristic starts at a load of 50% [8]. The fact is explained by a significant deterioration in the spraying process accompanied by the enlargement of the droplets.

For medium-speed engine with a higher supercharging and cylinder power of about 500 kW [11], carbon emissions increase linearly in the range of loads from the nominal to 0.75, after which the emissions increase with varying degrees of intensity. The reason for this change is a deterioration of the quality of fuel atomization in systems with a mechanical injection pump from the crankshaft, since the geometric characteristics of fuel-injection pump elements are optimized for loads close to the nominal one. Therefore, for the internal combustion supercharged engines it is necessary to supplement the index (BCD), characterizing the dynamics of combustion, with a calculated diameter of the fuel droplets within the investigated and nominal modes:

$$c=f(\text{BCD} \cdot d_r) \tag{7}$$

If the droplets average arithmetic diameter is set (Fig. 1), the carbon emission curve is somewhat smoothed out.

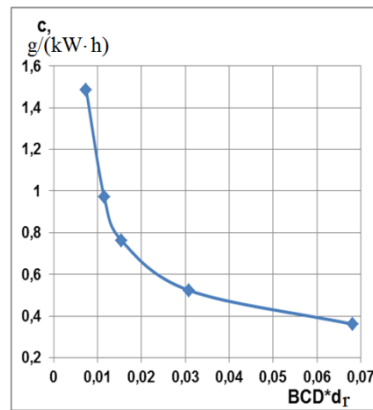

Figure 1. Dependence of the carbon content in the exhaust gases of the medium – speed marine diesel engines with a cylinder power of 500 kW taking into account the arithmetic average diameter of the droplets

Application as a generalizing diameter d_{30} or d_{32} [9] type practically does not change the dependence (Figure 1):

$$c = 0.064 (\text{BCD} \cdot d_r)^{0.618} \tag{6}$$

The linearization of a function can be obtained by its logarithm:

$$\text{Ln}(c) = -0.618 \text{Ln}(\text{BCD} \cdot d_r) - 2.749 \tag{7}$$

The reliability of $R^2 = 0.974$ for the functions (6) and (7).

As it can be seen from the graph, the lower the quality index of the process flow the higher the carbon emission in the exhaust gases. With a decrease in the indicator $(\text{BCD} \cdot d_r)$ by 10%, the carbon content increases by an average of 8.5%, and at loads less than 50% - by 9.3%.

As follows from equations (2) - (4), the decrease in the BCD index can occur due to a deviation in the operation of each of the factors included in them.

The regularity of the change in the content of nitrogen oxides in the exhaust gases of the medium-speed engine with a cylinder power of 500 kW at 720 rpm in the entire range of load characteristics is a line of two sections, each of which is close to a straight line (Figure

2). When the load decreases from nominal to 50% (the corresponding change in the index ($BCD * d_r$) from 0.0682 to 0.0239) is accompanied by a 14% reduction in nitrogen oxide emissions (from 8.7 to 7.5 g/(kW*h)). Further reduction in load and index ($BCD * d_r$) results in a significant increase in NOx emissions.

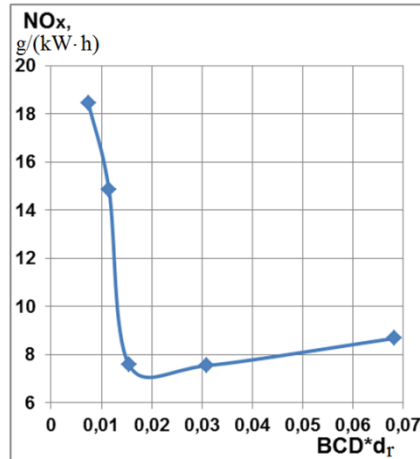

Figure 2. Dependence of nitrogen oxide emissions on the complex of BCD * workflow indicators

The graph of figure 2 is approximated by two straight lines. On the load section, 10-50%

$$NO_x = -1342.5 (BCD * d) + 29.031 \quad (8)$$

At the load area of 50-100%

$$NO_x = 1.145 (BCD * d) + 0.0328 \quad (9)$$

The use of a gas analyzer with functions for determining the concentration of carbon and nitrogen oxides will allow us to find the boundary between the normal technical state and the beginning of its deterioration.

The enlarged algorithm for assessing the technical performance of diesel includes the following operations:

1. For each model of the diesel engine, at the manufacturer's test bench or during delivery trials, the dependences of the change in the carbon content and nitrogen oxides on the screw characteristics or in a series of load characteristics (for several values of $n = \text{const}$) for the main engines are found. For diesel generators, several modes are considered with respect to the load characteristic with a nominal speed of rotation. The dependence of the cyclic fuel supply and the position of the load indicator is established.
2. Comparison of the calculated dependences with the experimental data obtained during bench tests or delivery trails for the passport technical condition and experimental conditions; equations of the form (8) - (11) are made. The comparison allows to obtain the discrepancy coefficients.

3. During the operation, carbon emissions and nitrogen oxides are monitored and compared with the dependencies obtained earlier (paragraph 2) taking into account the discrepancy coefficients.
4. The computational modeling on the computer the values of the complexes of the parameters B, C and D (expressions (2) - (4)) are calculated, as well as the temperature of the exhaust gases and the maximum combustion pressure when the parameters of the external environment change (barometric pressure, temperature and relative humidity) , technical condition of the fuel equipment (average fuel pressure, coking and wear of the nozzle openings), pressurization and gas exchange systems (pressure and charge air temperature, final compression pressure) and cylinder-piston group(final compression pressure).
5. Carbon and nitrogen oxides in exhaust gases are measured in operation and compared with previously obtained regularities (clause 2). In the case of exceeding the values of carbon concentrations and nitrogen oxides the active factors entering into expressions (2) - (4) are analyzed.
6. If the parameters that depend on hydrometeorological conditions are different the corresponding changes in the values of complexes B, C, D and emission concentrations are calculated under the condition of the passport technical condition of the engine. If the calculated value of the influence of hydrometeorological conditions compensates for the change in the amount of emissions the elements of the diesel are in a satisfactory condition. If not, we proceed to the next diagnostic procedure
7. The technical condition of the fuel equipment is checked either with the help of the measuring complex or in its absence by changing the additional estimated parameters - the temperature of the exhaust gases and the maximum combustion pressure.

CONCLUSION

The analysis of the results of experimental studies on the estimation of carbon emissions and nitrogen oxides with exhaust gases of marine diesel engines with supercharging and without boosting is carried out. It was found that in engines without a boost, for example, NVD24, the dependence of carbon emissions on the BCD index is linear. In engines with supercharged linear dependence is valid in the range of loads from 50 to 100%. With further reduction of the load there is an intensive increase in emissions due to the fact that the geometric characteristics of the elements of the fuel-injection pump are selected by the manufacturing plants for the modes close to the operational and full load. Therefore, in partial modes these parameters become overestimated that worsens the quality of the processes of spraying, mixture formation and combustion and determines the intensive growth of harmful emissions. In order to take into account this circumstance, the indicator that characterizes the flow of spraying, mixing and combustion processes is supplemented taking into account the

representative diameter of the fuel droplets. As the ratio of arithmetic mean diameters of droplets at the current mode of operation of the diesel and at full load mode is accepted.

As a result, the dependencies of carbon emissions are rectified, that indicates the adequacy of the accepted $BCD * d_r$ indicator which has been tested in several sizes of diesel engines. Its application to the current indicators and methods of diagnosis will allow more accurate assessment of the technical condition of internal combustion engine. An algorithm for diagnosing the engine by its exhausted gas composition has been developed.

LITERATURE

- [1] Odintsov VI, Glazkov D.Yu., Sviridyuk N.V. Algorithm for modeling indicators characterizing the conditions for the safe operation of the diesel engines of the fishing fleet.// 5th International Baltic Sea Forum. Theses of reports. Part 1, p.152-154.
- [2] The theory of internal combustion engines. Work processes. Ed. N.H. Dyachenko. L. : Shipbuilding, 1974. - 552 p.
- [3] Camfer G.M. Processes of heat and mass transfer and evaporation during the mixture formation in diesel engines. M., Higher School, 1974. - 144 p.
- [4] Brose D.D. Combustion in piston engines. M., Mechanical Engineering, 1969, - 248 p.
- [5] Victor Odintsov. Working process of ship engines. Monograph, Kaliningrad, BHARF, 2010. - 135 p.
- [6] Ivanov LA Heat stress and operational reliability of the cylinder-piston group of the marine diesel engine. Murmansk, Murmansk book publishing house, 1974. - 208 p.
- [7] Vaskevich F.A. Increase of efficiency of operation of the main marine diesel engines by methods of regulation and diagnostics of fuel equipment. // dis. Doctor of Technical Sciences, St. Petersburg, 2006. - 267 p.
- [8] Odintsov VI, Glazkov D.Yu. Provision of conditions for safe operation of marine ICE by limiting emissions of incomplete combustion products. // Bulletin of the Astrakhan State Technical University, ser. "Marine Engineering and Technology", Astrakhan, No. 4, 2016, - p. 70-76.
- [9] Lyshevsky A.S. Spraying of fuel in marine diesel engines. L., Shipbuilding, 1971. - 248 p.
- [10] Odintsov VI, Glazkov D.Yu. Some patterns of soot formation in ship engines. // Bulletin of the Astrakhan State Technical University, ser. "Marine Engineering and

Technology", Astrakhan, No. 3, 2014, - p. 83-88.

[11] Ship's documentation

RISK REGIONAL ZONATION OF ENVIRONMENTAL POLLUTION ON THE PORT OF HAI PHONG, VIETNAM AND THE SURROUNDING AREA

LE THI HUONG GIANG^{*}, NGUYEN THI THE NGUYEN[†], NGUYEN THANH SON[†]

^{*} Faculty of Hydraulic Engineering
Vietnam Maritime University
484 Lach Tray, Le Chan, Hai Phong, Vietnam
e-mail: gianglh.ett@vimaru.edu.vn, web page: <http://www.vimaru.edu.vn>

[†] Faculty of Coastal and Marine Engineering
Thuy loi University
175 Tay Son, Dong Da, Hanoi, Vietnam
e-mail: nguyen.n.t@tlu.edu.vn, web page: <http://www.tlu.edu.vn>

Keywords: Marine pollution, risk zonation, port and maritime activities

Abstract. The Port of Hai Phong has been recognized as the largest seaport in the north of Vietnam. The extension and the growth of international trade in this port have resulted in corresponding rapid growth in amount of goods, as well as the impacts on the marine environment. For years, the port operations and maritime activities in Hai Phong have caused significant damage to water quality and subsequently to marine life and ecosystems, as well as human health. This study illustrates an approach to zone the environmental risk of pollution on coastal and marine areas on the basis of three criteria: the level of pollution (or the risk of pollution), the extent of pollution impact, and the vulnerability of risk receptors. The result showed that the Port of Hai Phong and the surrounding area were comprised of four zones: very high, high, medium, and low degrees of risk; in those zones, factors that may cause maritime hazard, such as meteorological conditions, hydrology, topography, geology, ship life, maritime density, transport categories, and risk management factors are all taken into consideration. The risk map, thus, provided a basis for the implementation of control measures as a part of the environmental risk prevention and management.

1 INTRODUCTION

The Port of Hai Phong has been recognized as the largest seaport in the north of Vietnam by cargo volume, which offers advanced facilities, complete and safe infrastructure suitable for multi-modal transportation, and international trade. The Port of Hai Phong consists of different main branches, including Chua Ve Terminal, Hoang Dieu Port, Dinh Vu Port, Tan Vu Port. Main services of the Port are: 1) cargo handling, bagging/packing, tallying and warehousing; 2) Tug assistance and maritime salvages to ocean vessels; 3) Cargo transit and

container transshipment services; 4) Transport agent and forwarding; 5) Logistics services of container transport by Hai Phong - Lao Cai rail-way route; 6) On-land and by-waterway transport; and 7) Ship agent and maritime brokerage. Cargo throughput at the Port in 2015 was 23,748,843 (MT), and 14,407,703 TEUs.



Figure 1: Container terminals in Hai Phong Area

The Vietnamese government is planning to upgrade the Port of Hai Phong. Lach Huyen Port is being built as a general port, and container port. It will be the main wharf area of the Port of Hai Phong, and be capable to receive ships of 50,000 to 80,000 DWT by 2020. Dinh Vu area is being dredged and renovated to be able to receive ships of 20,000 to 30,000 DWT (Figure 1). Another port will be built in Yen Hung as a specialized wharf that can accommodate 30,000 to 40,000 DWT vessels. In addition, there is Nam Do Son wharf used for national security. This extension and the growth of international trade in the Port of Hai Phong have resulted in corresponding rapid growth in amount of goods being shipped by sea, as well as the impacts on the marine environment. For many years, the port operations and maritime activities in Hai Phong have caused significant damage to water quality and subsequently to marine life and ecosystems, as well as human health.

Regional environmental risk assessment (ERA) can be defined as a risk assessment which deals with a spatial scale that contains multiple habitats with multiple sources of many stressors affecting multiple endpoints. The characteristics of the landscape also affect the estimated risk [1]. The regional ERA is more complex than the general ERA because all risk receptors, risk sources, risk exposure, uncertainty, and especially spatial heterogeneity, are taken into account. The regional ERA results in a risk zoning map to help risk analysts and scientists explore the spatial nature of pollutant concentrations, exposure, and effects. Moreover, it also constitutes a very powerful tool to communicate the outcome of complex ERA [1]. Indicators used to display risks are often indices or quotients like the toxicity exposure ratios, hazard quotient, and risk quotient. Regional risk zonation of environmental pollution is useful for the protection of marine resources and the development of sea-based

economic sectors. However, the number of studies on environmental risk as a complex system of multiple factors and effects caused by regional environmental risks on the marine and coastal areas is still limited [3].

This study presents an approach to carry out regional risk zonation of marine pollution on the Port of Hai Phong and the surrounding area. Comprehensive risk index values were calculated and a quantitative risk zoning map can be obtained on the basis of risk index system. The quantitative risk zoning map provides a basis to implement control measures as a part of the environmental risk prevention and management for the largest seaport in the north of Vietnam.

2 MATERIALS AND METHODS

2.1 Computational grid

To assess the environmental risk, the research region should first be divided into smaller units. Rectangular/square grids, administrative grids, industrial parks, or industrial development zones have been used as units in previous studies [2]. In this study, the rectangular grid was applied as the zonation unit, because it has been proved to be an appropriate mesh in dealing with regional environmental risk caused by complex pollution from multi-sources, multi-paths and multi-objects [5].

According to Vietnamese regulation on zoning of environmentally polluted risk on sea and islands (henceforth, Vietnamese regulation) [7], the grid division must be based on the geography and geomorphology of the land shorelines, the dynamic regime, the coastal and marine ecosystems, and the socioeconomic activities. Lengths of coastal grids and marine grids do not exceed 03 nautical miles and 12 nautical miles, respectively.

2.2 Comprehensive risk index (I_g)

The environmental pollution risk on each grid (I_g) comprises three criteria (Table 1), namely the risk of pollution (I_p), the extent of pollution impact (I_i), and the vulnerability of risk receptors (I_v).

Table 1: Zonation index system

| Comprehensive index | Criteria | Primary index |
|---------------------------------------------------|---------------------------------------------|---------------|
| Environmental pollution risk (I_g) | The risk of pollution | I_p |
| | + <i>Maritime risk factors</i> | I_f |
| | + <i>Maritime risk management,</i> | I_m |
| | + <i>Status of marine water quality</i> | I_s |
| | Extent of pollution impact | I_i |
| | Vulnerability | I_v |
| | + <i>Likelihood of harm to human health</i> | I_h |
| + <i>Likelihood of harm to marine ecosystems</i> | I_e | |
| + <i>Likelihood of harm to sea use activities</i> | I_u | |

Source: Vietnamese regulation on zoning of environmentally polluted risk on sea and islands

The environmental pollution risk index is defined by Formula (1).

$$I_g = (2I_p + I_i + 3I_v)/6 \quad (1)$$

where:

“ I_g ” = the comprehensive risk index on each grid.

“ I_p ”, “ I_i ”, and “ I_v ” = the indices of the risk of pollution (or the level of pollution), the extent of pollution impact, and the vulnerability of risk receptors respectively.

The comprehensive risk index (I_g) is divided into 4 categories: very high risk area where $I_g > 2.6$; high risk area where $2 \leq I_g \leq 2.6$, medium risk area where $1.5 \leq I_g < 2.0$, and low risk area where $I_g < 1.5$.

2.3 The risk of pollution (I_p)

The risk of pollution (I_p) was assessed and ranked according to maritime risk factors (I_f), maritime risk management (I_m), and the status of marine water quality (I_s).

$$I_p = (I_f + I_m + I_s)/3 \quad (2)$$

Factors that may cause maritime hazard such as meteorological conditions, hydrology, topography, geology, ship life, maritime density, transport categories, and risk management factors such as maritime assistance, depth assurance, and plans, measures and manpower responding to the risk of environmental pollution, are all taken into consideration. All of the above indices have different component indices that are quantified by scoring from 1 to 4. The scoring method is presented in a study by Giang et al. [8]. In this study, all component indices of the index “ I_p ” were ranked according to practical conditions in each zonation unit.

2.4 The extent of pollution impact (I_i)

This index is given from 1 to 4 depending on the impact of pollution in the calculated grid on adjacent grids. Detailed guideline for scoring of this index is showed in the Vietnamese regulation [7]. In this study, this index was determined based on the results of a hydrodynamic model developed for these areas. A 2D tidal current – wave was developed for this area by applying the DELFT3D model. Based on the flow regime and rate, we determined the value of “ I_i ”.

2.5 The vulnerability of risk receptors (I_v)

The vulnerability is determined by the mean of three indicators, including the likelihood of harm to human health (I_h), to marine ecosystems (I_e), and to sea use activities (I_u). The scoring method is presented in the Vietnamese regulation [7]. In this study, component indices of the vulnerability index (I_h , I_e , I_u) were scored depending on actual natural and socio-economic characteristics in each zonation unit and by the judgment of a panel of experts.

$$I_v = (I_h + I_e + I_u)/3 \quad (2)$$

2.6 Risk zonation map

The results of the comprehensive risk indices were mapped by using GIS tool and then a risk zonation map of environmental pollution was obtained.

3 RESULTS AND DISCUSSION

3.1 Computational grid

Computational grids are presented in Figure 2.

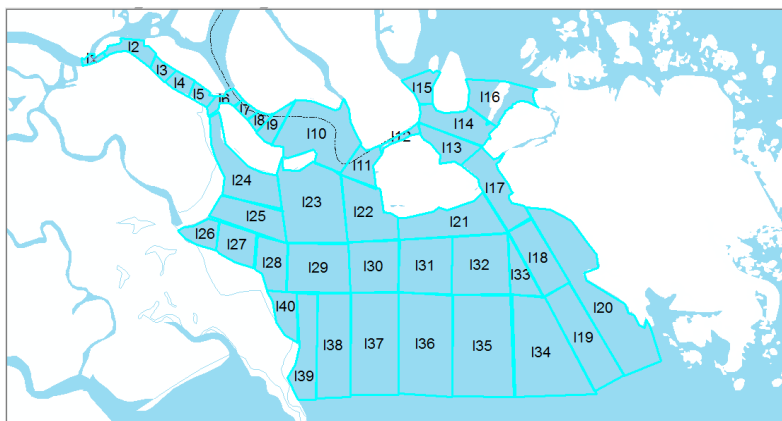

Figure 2: Computational grids

The study area was divided into 40 rectangular grids. The minimum grid size was 0.55 km^2 and the maximum grid size was 22.17 km^2 . The total calculated domain (along the coastline) was about 310 km^2 . Small grids were concentrated in the seaport waters or access channels, where there are many maritime activities. Larger grids were located in offshore waters.

3.2 Comprehensive risk index and risk zonation map

Table 1 shows the calculated results of the component and comprehensive risk indices. Based on these results, a risk zonation map of environmental pollution has been conducted and is shown in Figure 3. The Port of Hai Phong and the surrounding area comprised four zones according to very high, high, medium, and low risk degrees of marine pollution.

The red areas in the Figure 3 are very high risk zones, which make up 6% of the study area. These areas were located at Cam River Channel (from Hoang Dieu Port to Tan Vu Terminal) and in Ha Nam Channel. The comprehensive risk score ranged from 2.6 to 2.7. High risk values appeared around Hoang Dieu Port and Chua Ve Terminal, as these were densely populated residential areas with many marine uses, resulting in very high risk of pollution to human health, and the marine environment. Moreover, these areas are narrow but there are many ships passing by. Besides, the water environment here is also receiving domestic waste water from Hai Phong City, so the quality of water is rather low. Active and effective risk management measures must be taken in these areas to minimize the environmental pollution to the surrounding area.

The channels of Bach Dang and Lach Huyen, and a part of Van Uc Estuary had high risk of marine pollution (in orange in the Figure 3). Bach Dang and Lach Huyen Channels are the main navigation channels with high density of maritime activities, but their topography is complex; consequently, risk of marine pollution is high. In general, the high-risk areas accounted for 30% of the study area.

The yellow areas are medium risk zones, which make up 28% of the study area. These were estuary areas located outside the maritime access channels leading into the ports,

including Van Uc Estuary, the south of Tan Vu and Dinh Vu Ports. These areas did not have any maritime activity, but were directly affected by the risk of environmental pollution caused by maritime incidents in Hoang Dieu Port, along Bach Dang Channel, or possibly in the Ha Nam Channel. The comprehensive risk index values ranged from 1.5 to 1.9. The south of Tan Vu - Dinh Vu Ports had higher values of comprehensive risk index because it was directly affected by the risk of environmental pollution from the main channel. About 36% of the study area belonged to low risk zones (in green in the Figure 3). This area included the offshore of Hai Phong City. This area did not have any maritime activities, so it was not directly affected by pollution from these activities. Moreover, there was no marine exploitation, no human activity, and no important ecosystems or protected areas in this area.

Table 2: Results of the primary and comprehensive risk indices

| Gird | I_r | I_m | I_s | I_p | I_i | I_h | I_e | I_u | I_v | I_g | Risk level |
|-------------|----------------------|----------------------|----------------------|----------------------|----------------------|----------------------|----------------------|----------------------|----------------------|----------------------|-------------------|
| I1 | 2 | 1.8 | 4 | 2.6 | 1 | 3 | 2 | 4 | 3.0 | 2.5 | high |
| I2 | 2 | 1.8 | 4 | 2.6 | 2 | 3 | 2 | 4 | 3.0 | 2.7 | very high |
| I3 | 1.7 | 1.8 | 4 | 2.5 | 2 | 3 | 2 | 4 | 3.0 | 2.7 | very high |
| I4 | 1.9 | 1.8 | 4 | 2.6 | 2 | 3 | 2 | 4 | 3.0 | 2.7 | very high |
| I5 | 1.9 | 1.8 | 4 | 2.6 | 2 | 3 | 2 | 3 | 2.7 | 2.5 | very high |
| I6 | 2.1 | 1.8 | 4 | 2.6 | 2 | 3 | 2 | 3 | 2.7 | 2.5 | high |
| I7 | 2.1 | 1.8 | 4 | 2.6 | 2 | 3 | 2 | 3 | 2.7 | 2.5 | high |
| I8 | 2.1 | 1.8 | 4 | 2.6 | 2 | 3 | 2 | 3 | 2.7 | 2.5 | high |
| I9 | 2.1 | 1.8 | 4 | 2.6 | 2 | 3 | 2 | 3 | 2.7 | 2.5 | high |
| I10 | 1.9 | 1.8 | 4 | 2.6 | 3 | 3 | 2 | 2 | 2.3 | 2.5 | high |
| I11 | 2.4 | 1.8 | 4 | 2.7 | 3 | 3 | 2 | 2 | 2.3 | 2.6 | high |
| I12 | 2.2 | 1.8 | 2 | 2.0 | 3 | 3 | 2 | 3 | 2.7 | 2.5 | high |
| I13 | 2.4 | 1.8 | 2 | 2.1 | 3 | 3 | 2 | 4 | 3.0 | 2.7 | very high |
| I14 | 1.7 | 1 | 1 | 1.2 | 2 | 1 | 2 | 2 | 1.7 | 1.6 | high |
| I15 | 1.7 | 1 | 1 | 1.2 | 2 | 1 | 2 | 2 | 1.7 | 1.6 | low |
| I16 | 1.7 | 1 | 1 | 1.2 | 2 | 1 | 2 | 2 | 1.7 | 1.6 | low |
| I17 | 2.2 | 1.8 | 1 | 1.7 | 3 | 3 | 2 | 4 | 3.0 | 2.6 | high |
| I18 | 2.3 | 1.8 | 1 | 1.7 | 3 | 3 | 2 | 4 | 3.0 | 2.6 | high |
| I19 | 1.9 | 1.8 | 1 | 1.6 | 3 | 3 | 2 | 4 | 3.0 | 2.5 | high |
| I20 | 1.4 | 1 | 1 | 1.1 | 3 | 3 | 1 | 1 | 1.7 | 1.7 | medium |
| I21 | 1.4 | 1 | 1 | 1.1 | 3 | 3 | 1 | 1 | 1.7 | 1.7 | medium |
| I22 | 1.4 | 1 | 4 | 2.1 | 3 | 3 | 1 | 1 | 1.7 | 2.0 | high |
| I23 | 1.4 | 1 | 4 | 2.1 | 3 | 3 | 1 | 1 | 1.7 | 2.0 | high |
| I24 | 1.4 | 1 | 4 | 2.1 | 3 | 3 | 1 | 1 | 1.7 | 2.0 | high |
| I25 | 1.4 | 1 | 4 | 2.1 | 3 | 3 | 1 | 1 | 1.7 | 2.0 | high |
| I26 | 1.4 | 1 | 3 | 1.8 | 3 | 3 | 1 | 1 | 1.7 | 1.9 | medium |
| I27 | 1.4 | 1 | 3 | 1.8 | 3 | 1 | 1 | 1 | 1.0 | 1.6 | medium |
| I28 | 1.4 | 1 | 3 | 1.8 | 3 | 1 | 1 | 1 | 1.0 | 1.6 | medium |
| I29 | 1.4 | 1 | 3 | 1.8 | 3 | 1 | 1 | 1 | 1.0 | 1.6 | medium |
| I30 | 1.4 | 1 | 3 | 1.8 | 3 | 1 | 1 | 1 | 1.0 | 1.6 | medium |

| | | | | | | | | | | | |
|-----|-----|---|---|-----|---|---|---|---|-----|-----|--------|
| I31 | 1.4 | 1 | 3 | 1.8 | 3 | 1 | 1 | 1 | 1.0 | 1.6 | medium |
| I32 | 1.4 | 1 | 2 | 1.5 | 3 | 1 | 1 | 1 | 1.0 | 1.5 | medium |
| I33 | 1.4 | 1 | 1 | 1.1 | 3 | 1 | 1 | 1 | 1.0 | 1.4 | low |
| I34 | 1.4 | 1 | 1 | 1.1 | 3 | 1 | 1 | 1 | 1.0 | 1.4 | low |
| I35 | 1.4 | 1 | 1 | 1.1 | 3 | 1 | 1 | 1 | 1.0 | 1.4 | low |
| I36 | 1.4 | 1 | 1 | 1.1 | 3 | 1 | 1 | 1 | 1.0 | 1.4 | low |
| I37 | 1.4 | 1 | 1 | 1.1 | 3 | 1 | 1 | 1 | 1.0 | 1.4 | low |
| I38 | 1.4 | 1 | 1 | 1.1 | 3 | 1 | 1 | 1 | 1.0 | 1.4 | low |
| I39 | 1.4 | 1 | 1 | 1.1 | 3 | 1 | 1 | 1 | 1.0 | 1.4 | low |
| I40 | 1.4 | 1 | 1 | 1.1 | 3 | 1 | 1 | 1 | 1.0 | 1.4 | low |

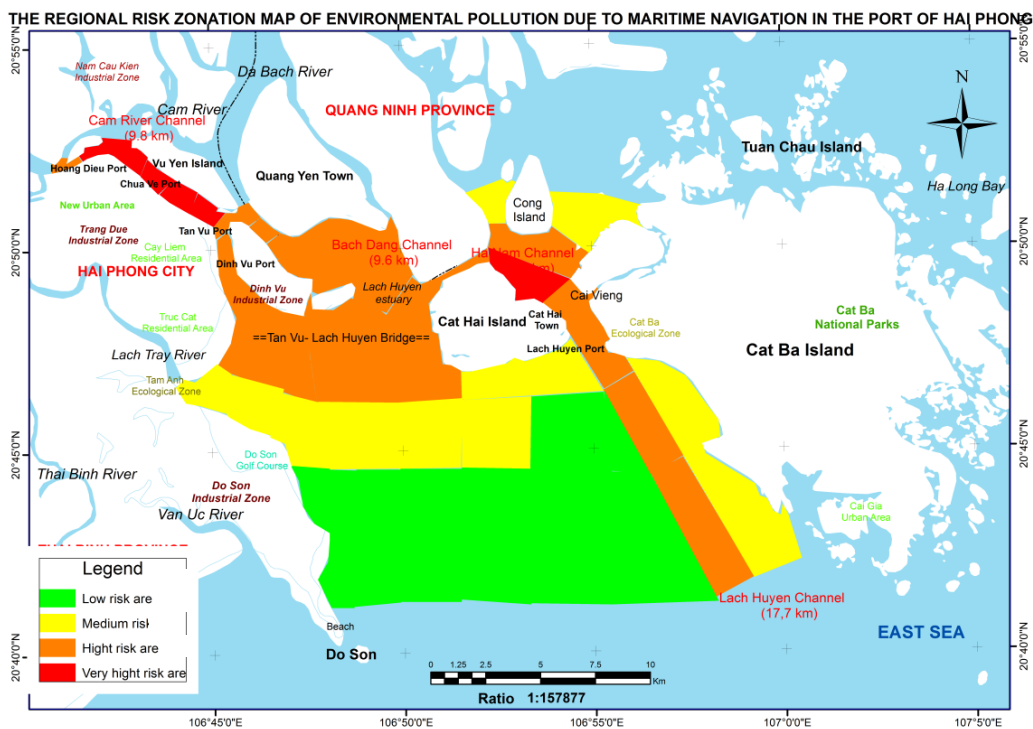

Figure 3: The regional risk zonation map of environmental pollution due to maritime activities in the Port of Hai Phong

3.3. Some recommendation for control measures

As the results of the study, 36% of the study area has high to very high level of environmental pollution risk. These areas located at all main channels, and harbor basins. Some control measures could be specified for the risk areas as the followings:

- The areas from Hoang Dieu Port to Lach Huyen Estuary: These areas have high maritime traffic and many seaports. It also receives all industrial and domestic wastewater from Hai Phong city. Therefore, risk management measures need to focus on two aspects: 1) managing maritime risks and 2) minimizing pollution of land sources. The “I_s” indexes in these areas always at their highest levels, so much attention should be paid to minimize pollution from

the mainland. To do this, domestic and industrial wastewater must be collected, and standardly treated before discharging to the environment. For maritime risk management, the Maritime Administration of Hai Phong need to develop a reasonable ship schedule, invest, manage and well exploit the VTS system, and regularly dredge the channels to ensure the navigation depth.

- The Ha Nam Channel: The risk of environmental pollution in this area is mainly caused by the risk of unsafe navigation. Therefore, maritime safety risk management is the only measure that should be applied to this area. As stated above, reasonable ship schedule, good exploitation of the VTS system, ensuring the navigation depth are some control activities to keep the safe navigation.

4 CONCLUSIONS

The results of the study showed that 64% of the Port of Hai Phong and surrounding area had low to medium risk of environmental pollution with the comprehensive risk value of from 1.4 to 1.9. The medium risk zones were concentrated at Van Uc Estuary, and from the south of Tan Vu - Dinh Vu Ports to the sea. Area with a low risk was offshore area far from the ports. Areas with high level of environmental pollution risk accounted for 30% of the study area and were concentrated in all main channels, and harbor basins. Only 6% of the study area had very high risk level. These areas were located at the Cam River channel (from Hoang Dieu Port to Tan Vu Terminal) and in Ha Nam Channel. These areas need to have active and effective risk management measures to reduce the environmental pollution to the surrounding area.

REFERENCES

- [1] Xu, L. and Liu, G. The study of a method of regional environmental risk assessment. In: *Journal of Environmental Management*. The Netherlands: Elsevier Ltd., 2009, 90, 3290–3296.
- [2] Lahr J. and Kooistra L. Environmental risk mapping of pollutants: state of the art and communication aspects. In: *Science of the Total Environment* [online]. The Netherlands: Elsevier Ltd., 2010, 408, 3899–3907. [viewed date 12 April 2018]. Available from: < Doi: 10.1016/j.scitotenv.2009.10.045 >
- [3] Nguyen, N.T.T. and Gretchen, G. Regional Risk Zonation of Environmental Pollution on Marine and Coastal Zone, In: *Journal of Marine Environmental Engineering*. US: Old City Publishing, Inc., 2018, 10(2), 97-107.
- [4] Liu, R. Z. and others. Zoning Abrupt Environmental Pollution Risk in a Mega-city. In: *Procedia Environmental Sciences*. The Netherlands: Elsevier Ltd., 2010, 2, 1022–1031.

- [5] Shao, C. and others. Integrated Environmental Risk Assessment and Whole-Process Management System in Chemical Industry Parks. In: *International Journal of Environmental Research and Public Health*. Switzerland: MDPI, 2013, 10(4), 1609–1630. [viewed date 12 April 2018]. Available from: < Doi: 10.3390/ijerph10041609 >
- [6] Xu, X. G. and others. Probe into the Method of Regional Ecological Risk Assessment - A Case Study of Wetland in the Yellow River Delta in China. In: *Journal of Environmental Management*. The Netherlands: Elsevier Ltd., 2004, 70, 253–262.
- [7] MONRE, Vietnam Regulation on Criteria of Risk Classification and Zoning of Environmental Pollution at Sea and Islands, Vietnam Ministry of Natural Resources and Environment, 2016.
- [8] Giang, L.T.H. and Nguyen, N.T.T. A Study on Proposing Additional Criteria of Environmental pollution risk in the Circulation No. 26/2016/TT-BTNMT on Maritime Areas. In: *Journal of Maritime Science and Technology*. Vietnam: Vietnam Maritime University, 2018, 54, 43-50.

THE REPELLING EFFECT OF GOLDEN APPLE SNAIL (*Pomacea canaliculata*) EGG EXTRACT ON ALGAE

Glenn Anjo C. Casiano¹, Hermes Paul T. Catalayban², Christine M. Melliza³,
Renier Mhart M. Parreño⁴, and Vincent L. Vecendario⁵

⁵John B. Lacson Foundation Maritime University-Arevalo
Sto. Niño Sur, Arevalo, Iloilo City, Philippines
e-mail: vince.weak09@gmail.com

Keywords: golden apple snail, antifouling, blocks, algae, overubin, PcPV2.

Abstract. There is an ongoing search for an alternative way to repel algae that is environmentally friendly, thus, this study was conducted. This study aimed to determine the repelling effect of golden apple snail (*Pomacea canaliculata*) egg extract on algae. Pure natural extract of golden apple snail eggs was taken and mixed with ordinary paint in different concentrations. Five metal sheets with three replicates for a total of 15 metal sheets in each block were prepared and painted with treatments. The metal sheets were distributed randomly in each of the three blocks and were exposed to the sea at an average depth of two meters for four days. Randomized complete block design (RCBD) was utilized as a research design of the study. Prior the final experiment, there were 6 treatments that undergone toxicity testing namely Treatment A - 80% (200 ml) golden apple snail egg extract and 20% (50 ml) ordinary paint, Treatment B - 50% (125 ml) golden apple snail egg extract and 50% (125 ml) ordinary paint, Treatment C - 20% (50 ml) golden apple snail egg extract and 80% (200 ml) ordinary paint, Treatment D - 100% (250 ml) antifouling paint 1 (positive control), Treatment E - 100% (250 ml) antifouling paint 2 (positive control), and Treatment F - 100% (250 ml) ordinary paint (negative control). Since the tested Treatment B was toxic because it had a result of 100% mortality rate on algae when tested during toxicity testing, it was removed. Thus, Treatment C was named to Treatment B and so forth to make it continuous. After the toxicity testing and final experiment, Treatment A had the least mean weight of 0.10 g of attached algae while Treatment E (100% ordinary paint) had the greatest mean weight of 0.94 g of attached algae. Block 2 (Villa Beach) had the least mean weight of attached algae on metal sheets after four days of sea exposure with a mean weight of 0.20 g for descriptive data analysis. For inferential data analysis, there were significant differences in the mean weight of attached algae after applying with various treatments and blocks for four days. Result showed that Treatment A, Treatment B, and Treatment D were the best treatments while Block 2 had the least mean weight of attached algae. It is recommended to use Treatment A (80% golden apple snail egg and 20% ordinary paint) because it had the least mean weight of attached algae and it has the presence of overubin and PcPV2 which were toxins found on golden apple snail eggs (Dreon, Frassa, Ceolín, Ituarte, Qiu, Sun, Fernández, and Heras, 2013). These two toxins might be the reason for the repelling effect of *P. canaliculata* to algae. The conceptualization of this study is based on a maritime issue specifically biofouling on ships.

1 INTRODUCTION

Fouling is the unwanted growth of organisms on ship's hull or any man-made structure submerged at sea (IMO, 2003). Fouling on ships results to reduction of speed. As a result, an increase of fuel consumption is needed for ships to travel to its destination thus more money is needed. This effect is due to the resistance of the hull's movement through the water (US Naval Institute, 1952).

For centuries, it became a problem in the maritime industry, but during 1960s the organotin compound tributyltin (TBT) was used to coat ship's hull to act as an antifouling system. However, during the 1970s and 1980s, it was discovered that TBT is toxic for the marine organisms such as shellfish. Thus, in 1990 the International Maritime Organization (IMO) adopted a resolution which eliminate antifouling paints containing TBT and in January 2008 the complete prohibition was accomplished (IMO, 2003). As a result of ecological impact of TBT, there is a continuous search for antifouling compounds that are economically and environmentally friendly. The search of finding an antifouling material is to utilize a readily available and non-toxic material such as the eggs of a pest specifically the golden apple snail (Gopikrishnan, Radhakrishnan, Pazhanimurugan, Shanmugasundaram, and Balagurunathan, 2015).

Golden apple snail or *Pomacea canaliculata* is an invasive snail species from South America introduced to Asian countries including the Philippines to fight protein deficiency (International Rice Research Institute, 2017). But due to the loss of its commercial use, it was neglected in which it spread and became one of the major rice pests in the Philippines. During spawning season, the females crawl out of the water and lay 25-500 eggs which hatch in 10 to 15 days (New Pest Advisory Group, 1998). Its eggs contain a biochemical defense which includes ovorubin which have anti-digestive and anti-nutritive properties and PcPV2 neurotoxin (Dreon et al., 2013).

There are more than 4000 species of fouling organisms, mostly found near sea inlets and shallow waters due to the availability of nutrients. These organisms may also be introduced to other places by ship hulls when the attached species release larvae and leave them at new different ports (Corrosionpedia, 2018). Algae are aquatic organisms that have the ability to conduct the process which uses sunlight to create food from carbon dioxide and water or also known as photosynthesis (Vidyasagar, 2016). Algae can settle and develop on a broad range of surfaces including both natural and artificial or man-made structures. They are fast settlers and can displace numerous species in the competition for food, space and resources (Hellio, Lebret, and Thabard, 2009).

This study was conceptualized because of the following reasons: First, golden apple snail egg is readily available. Second, fouling can result to the deformation of ship's hull which lessens the ship's speed and increases the fuel consumption, and lastly, after the ecological effects of TBT, there is a worldwide continuous search for economically and environment-friendly antifouling materials (New Pest Advisory Group, 1998; US Naval Institute, 1952; Gopikrishnan et al., 2015).

This study was conducted in the coastal areas of Iloilo from Oton Beach, Oton, Iloilo passing Villa Beach, Villa, Iloilo City to Molo Beach, Molo, Iloilo City. The basis for blocking are due to high density of population and presence of commercial establishments along the beaches. The coastal waters of Iloilo are within the 200 MPN/100 ml standard for fecal coliform concentration. This means that the coastal waters of Iloilo are rich in coliform which could be considered nutrient to algae (Ambient Water Quality Report Annual, 2015).

In this study, mixtures of two different concentrations of ordinary paint and golden apple snail egg extract were the experimental treatments. Two different commercial brands of antifouling paints and an ordinary paint were the control treatments. Both groups are the independent variables. The weight of attached algae (g) on the metal sheets in a span of four days was the dependent variable. The mixtures were applied in the metal sheets which were exposed in the beaches of Oton, Iloilo (Block 1), Villa, Iloilo City (Block 2), and Molo, Iloilo City (Block 3) if it is effective in the prevention of the attachment of algae.

This study aimed to determine the repelling effect of golden apple snail (*P. canaliculata*) egg extract on algae after four days of exposure to seawater. Specifically, this study aimed to answer the following questions: 1. What is the toxicity level of golden apple snail (*P. canaliculata*) egg extract on algae and crabs? 2. What is the mean weight (g) of attached algae after applying with various treatments after four days of exposure to seawater? 3. What is the mean weight (g) of attached algae among blocks after four days of exposure to seawater? 4. Is there a significant difference in the mean weight (g) of attached algae after applying with various treatments for four days of exposure to seawater? 5. Is there a significant difference in the mean weight (g) of attached algae among blocks for four days of exposure to seawater?

2 MATERIALS AND METHODS

There were five treatments with three replicates that were used in this experiment: Treatment A - 80% (200 ml) golden apple snail egg extract and 20% (50 ml) ordinary paint, Treatment B - 20% (50 ml) golden apple snail egg extract and 80% (200 ml) ordinary paint, Treatment C - 100% (250 ml) antifouling paint 1 (positive control), Treatment D - 100% (250 ml) antifouling paint 2 (positive control), and Treatment E - 100% (250 ml) ordinary paint (negative control). Prior the final experiment, there were 6 treatments that undergone Treatment A - 80% (200 ml) golden apple snail egg extract and 20% (50 ml) ordinary paint, Treatment B - 50% (125 ml) golden apple snail egg extract and 50% (125 ml) ordinary

paint, Treatment C – 20% (50 ml) golden apple snail egg extract and 80% (200 ml) ordinary paint, Treatment D – 100% (250 ml) antifouling paint 1 (positive control), Treatment E – 100% (250 ml) antifouling paint 2 (positive control), and Treatment F – 100% (250 ml) ordinary paint (negative control). Since the tested Treatment B was toxic, it was removed. Thus, Treatment C was named to Treatment B and so forth to make it continuous. These treatments were applied to metal sheets with corresponding concentrations and were exposed across Oton, Iloilo (Block 1), Villa, Iloilo City (Block 2) and Molo, Iloilo City (Block 3) Beaches, respectively at an average depth of two meters.

The following materials were used for the conduct of this experiment: 45 metal sheets (9 inches x 8 inches), paper tape, scissors, sand paper, mortar and pestle, beakers, golden apple snail egg taken from Poblacion South, Oton, Iloilo, commercial antifouling paints, bamboos, containers, ordinary paint (enamel), analytical weighing scale, scraper, wires, rope, pliers, floater, knife, and paint brush.

3 DATA COLLECTION

3.1 Extracting golden apple snail egg and conducting the toxicity test

Golden apple snail egg (taken from Poblacion South, Oton, Iloilo) was used for the experiment. In extracting golden apple snail egg, the researchers brought the snail eggs to a laboratory, and the researchers conducted an extraction with the assistance of the laboratory personnel. The extracted golden apple snail eggs were used in determining its toxicity level at Southeast Asian Fisheries Development Center/Aquaculture Department (SEAFDEC/AQD), Tigbauan, Iloilo, on algae (*Enteromorpha clathrata* Roth Greville) and crabs (*Scylla serrata*) (OECD Guideline for Testing of Chemicals, 1984).

3.2 Preparing the metal sheets, formulating the pain concentration and trial-and-error set-ups

Forty-five metal sheets with dimension of 9 inches x 8 inches were used. Four holes were placed on each edges of the metal sheets and were sanded down so that paint will adhere to the sheets efficiently. The golden apple snail egg extract was mixed with oil-based paint (enamel). The concentrations of the mixtures were based on the treatments. Trial-and-error set-ups were conducted for the purpose of reducing mistakes during the proper procedure of experiment and also to master the process.

3.3 Preparing and retrieving the experimental set-ups

The 45 metal sheets were coated with different concentrations of mixtures. Using fish-bowl method, random numbers were picked for the arrangement for each block. The set-up was composed of 15 experimental units with five treatments with three replicates for each

block. Randomized complete block design (RCBD) was utilized. The plates were labeled from A1 to A3, B1 to B3, C1 to C3, D1 to D3, and E1 to E3 for each block. The letters A to E were picked randomly to determine the arrangement of treatments on each block. Next, the metal sheets were hung with the use of a wire that was inserted into the holes on the edges of the sheets. The set-up was made of bamboos that were put together forming a frame secured with wires on corners and this acted as the base for the sheets to be hung. When the set-up was exposed into the water, empty containers served as floaters that acted as a marking guide for locating the set-up. After four days of exposure, the metal sheets were retrieved. The metal sheets which contain the needed results were preserved for the next process.

3.4 Determining the mean weight (g) of algae

The retrieved metal sheets were scraped individually by the researchers with the use of a scraper. The scraped algae were weighed separately and collected data were compared to determine the most effective treatment. Figure 2 shows the randomization of treatments with three replicates for each block.

4 DATA ANALYSIS

On the toxicity test of algae, it was measured by using percentage. For the descriptive data analysis, algae were counted in each treatment using mean and standard deviation as statistical tools and for inferential data analysis, randomized complete block design (RCBD) was used set at .05 level of significance.

For the Post hoc tests, the means of the treatments and blocks were compared using Scheffe test set at .05 level of significance.

For the toxicity test, LD50 or Lethal Dose 50 was used with the following scheme:

- > 50% - Toxic
- < 50% - Non-toxic

5 RESULTS AND DISCUSSION

5.1 Descriptive Data Analysis

5.1.1 Toxicity test results

Tables 1 and 2 shows the results of toxicity test on algae and crabs. Treatment B, a metal sheet with concentrations of 50% extracted golden apple snail eggs and 50% ordinary paint that was tested on crabs showed 20% mortality. A non-toxic description for Treatment B on crabs for the result was less than 50%.

On algae, it yielded a 100% mortality rate on both replicates and was described as toxic. All descriptions were based on LC50 protocol. Because of this, it was removed. See below.

5.1.2 Mean weight (g) of attached algae among treatments and among blocks

Table 3 shows the weight of attached algae (g) in averages of each replicates of each treatments and blocks. Treatment A (80% golden apple snail egg extract and 20% ordinary paint) having the mean weight of 0.10 g of attached algae and has the lowest among the treatments. Treatment E (100% ordinary paint), which is the negative control, having a mean weight of 0.94 g of attached algae and has the highest mean weight (g) among treatments.

Block 1 (Oton Beach) and Block 3 (Molo Beach) have the most attached algae on metal sheets after four days of sea exposure with the same mean weight of 0.42 g. Block II (Villa Beach) has the least attached algae with a mean weight of 0.20 g. See below.

5.2 Inferential Data Analysis

5.2.1 Significant difference in the mean weight (g) of attached algae on treatments and blocks

Table 4 shows that F computed for treatments, which is 4.97 is greater than F tabulated, which is 4.76. Thus, there is a significant difference in the mean weight (g) of attached algae among treatments and at least one has a different mean weight of attached algae, $F_{tab} > F_{comp}$.

On the other hand, F computed for blocks, is 8.20, is greater than F tabulated, which is 5.14. This means that there is a significant difference in the mean weight of attached algae among the blocks, $F_{tab} > F_{comp}$. See below.

Mean weights of each treatment are compared using Scheffe test as shown in Table 5. All the treatments are not significantly different from each other but only Treatment A (80% golden apple snail egg extract and 20% ordinary paint) and Treatment C (100% antifouling paint 1) are significantly different.

Thus, Treatment A, Treatment B and Treatment D are the best treatments having the least mean weights of attached algae.

Due to the effects of the compound tributyltin or TBT which is an ingredient on antifouling paints, there is still an ongoing search for alternatives of antifouling paint (Gopikrishnan et al., 2015). The presence of ovorubin which has an anti-nutritive and anti-digestive property and PcPV2 which is the only reported genetically encoded toxin found inside an egg were utilized as an alternative ingredient to antifouling paints (Dreon, Frassa, Ceolín, Ituarte, Qiu, Sun, Fernández, and Heras, 2013).

Mean weights of each block are compared using Scheffe test as shown in Table 6. Blocks 1 (Oton Beach) and 2 (Villa Beach) and Blocks 1 (Oton Beach) and 3 (Molo Beach) are not significantly different from each other but Block 2 (Villa Beach) is significantly different from Block 3 (Molo Beach).

Thus, Block 1 and Block 2 have the least mean weight of attached algae. According to Brunn (2012), algae quickly respond to changes like change in pH level, change in amount of sunlight, and change in salinity. The ratio of nitrogen and phosphorous in the body of water caused by water pollution, helps the growth and development of algae. That might be the reason why Blocks 1 & 2 have the least mean weight (g) of attached algae.

6 CONCLUSIONS

Based on the results, the following are concluded: Treatment B (50% golden apple snail egg extract and 50% ordinary paint) is toxic because LD50 protocol stated that if mortality rate was greater than 50%, the treatment used was toxic because it had a result of 100% mortality rate; Treatment A (80% golden apple snail egg extract and 20% ordinary paint), Treatment B (20% golden apple snail egg extract and 80% ordinary paint), and Treatment D (antifouling paint 2) were the best treatments since they had the least mean weights (g) of attached algae after four days of exposure to seawater. PcPV2 and overubin as toxin and protein present in golden apple snail egg has the anti-nutritive and anti-digestive property according to Dreon, Frassa, Ceolín, Ituarte, Qiu, Sun, Fernández, and Heras (2013) and were utilized as an alternative ingredient to antifouling paints that is used as an antifouling ingredient to repel the attachment of algae; and Block 2 (Villa Beach) and Block 1 (Oton Beach) were the best blocks since they have the least mean weights (g) of attached algae due to less presence of household in the location. According to Brunn (2012), algae rapidly react to changes like change in pH level, change in amount of sunlight, and change in salinity. The ratio of phosphorous and nitrogen in the body of water caused by pollution in the water, helps the growth and development of algae. That might be the reason why Block 2 has the least mean weight (g) of attached algae.

Table 1. Toxicity Result of Golden Apple Snail (*P.canaliculata*) Egg Extract on Algae (*E.clathrata Roth Greville*)

| Treatments | Weight (g) | | Ave. Wt. (g) | Initial Wt. (g) | Growth (g) | Total Wt. (g) | Mortality Rate (%) | Remarks |
|------------|------------|-------|--------------|-----------------|------------|---------------|--------------------|---------|
| | Wet | Dry | | | | | | |
| A1 | 50.53 | 47.27 | 48.90 | 10.11 | 1.37 | 11.48 | 0 | NT |
| A2 | 51.26 | 47.71 | 49.49 | 10.21 | 1.64 | 11.85 | 0 | NT |
| B1 | - | - | - | 10.23 | 0.00 | 0 | 100 | T |
| B2 | - | - | - | 10.04 | 0.00 | 0 | 100 | T |
| C1 | 53.94 | 52.56 | 53.25 | 10.18 | 0.92 | 11.10 | 0 | NT |
| C2 | 54.99 | 53.25 | 54.12 | 10.29 | 1.16 | 11.45 | 0 | NT |
| D1 | 52.78 | 50.84 | 51.81 | 10.31 | 1.10 | 11.41 | 0 | NT |
| D2 | 51.82 | 49.82 | 50.82 | 10.01 | 1.08 | 11.09 | 0 | NT |
| E1 | 53.77 | 50.98 | 52.38 | 10.09 | 1.27 | 11.36 | 0 | NT |
| E2 | 53.27 | 50.16 | 51.72 | 10.18 | 0.74 | 10.92 | 0 | NT |
| F1 | 52.3 | 50.73 | 51.52 | 10.07 | 1.91 | 11.98 | 0 | NT |
| F2 | 51.54 | 49.79 | 50.67 | 10.11 | 0.01 | 10.12 | 0 | NT |

Table 2. Toxicity Result of Golden Apple Snail (*P. canaliculata*) Egg Extract on Crabs (*S. serrata*)

| Treatments | No. of Crabs (N=5) | | Mortality Rate (%) | Remarks |
|------------|--------------------|-------|--------------------|---------|
| | Dead | Alive | | |
| A1 | 0 | 5 | 0 | NT |
| A2 | 0 | 5 | 0 | NT |
| B1 | 1 | 4 | 20 | NT |
| B2 | 0 | 5 | 0 | NT |
| C1 | 0 | 5 | 0 | NT |
| C2 | 0 | 5 | 0 | NT |
| D1 | 0 | 5 | 0 | NT |
| D2 | 0 | 5 | 0 | NT |
| E1 | 0 | 5 | 0 | NT |
| E2 | 0 | 5 | 0 | NT |
| F1 | 0 | 5 | 0 | NT |
| F2 | 0 | 5 | 0 | NT |

Note. NT = Non-toxic and T = toxic. Mortality rate for LD50: > 50% - Toxic and <50% - Non-toxic. Treatments A1 and A2 - 80% (200 ml) golden apple snail egg extract and 20% (50 ml) ordinary paint, Treatments B1 and B2 - 50% (125 ml) golden apple snail egg extract and 50% (125 ml) ordinary paint Treatments C1 and C2 - 20% (50 ml) golden apple snail egg extract and 80% (200 ml) ordinary paint, Treatments D1 and D2 - 100% (250 ml) antifouling paint 1 (positive control), Treatments E1 and E2 - 100% (250 ml) antifouling paint 2 (positive control), and Treatments F1 and F2 - 100% (250 ml) ordinary paint (negative control).

Table 3. Mean Weight (g) of Attached Algae After Four Days of Exposure to Seawater

| Blocks | Treatments | | | | | Total | Mean Wt. (g) | SD |
|--------------|------------|------|------|------|------|-------|--------------|------|
| | A | B | C | D | E | | | |
| 1 | 0.12 | 0.14 | 0.29 | 0.19 | 1.37 | 2.12 | 0.42 | 0.55 |
| 2 | 0.07 | 0.08 | 0.17 | 0.07 | 0.60 | 1.00 | 0.20 | 0.24 |
| 3 | 0.10 | 0.24 | 0.49 | 0.41 | 0.85 | 2.09 | 0.42 | 0.35 |
| Total | 0.29 | 0.46 | 0.95 | 0.68 | 2.83 | | | |
| Mean Wt. (g) | 0.10 | 0.15 | 0.32 | 0.23 | 0.94 | | | |
| SD | 0.05 | 0.09 | 0.17 | 0.18 | 0.55 | | | |

Note. Treatment A - 80% (200 ml) golden apple snail egg extract and 20% (50 ml) ordinary paint, Treatment B - 20% (50 ml) golden apple snail egg extract and 80% (200 ml) ordinary paint, Treatment C - 100% (250 ml) antifouling paint 1 (positive control), Treatment D - 100% (250 ml) antifouling paint 2 (positive control), and Treatment E - 100% (250 ml) ordinary paint (negative control). For blocks, Block 1 - Oton Beach, Iloilo Block 2 - Villa Beach, Iloilo City and Block 3 - Molo Beach, Iloilo City.

Table 4. Results of Randomized Complete Block Design (RCBD)

| Sources of Variation | df | SS | MS | F_{comp} | F_{tab} |
|----------------------|----|------|------|------------|-----------|
| Treatments | 3 | 0.08 | 0.03 | 4.97* | 4.76 |
| Blocks | 2 | 0.09 | 0.05 | 8.20* | 5.14 |
| Error | 6 | 0.03 | 0.01 | | |
| Total | 11 | 0.20 | | | |

Note. Asterisk (*) means significant at .05 level of probability.

Table 5. Comparison of Treatment Means Using Scheffe Test

| Treatments | Mean Wt. (g) of Attached Algae |
|------------|--------------------------------|
| A | 0.10 ^a |
| B | 0.15 ^{ab} |
| C | 0.32 ^b |
| D | 0.23 ^{ab} |

Table 6. Comparison of Block Means Using Scheffe Test

| Block | Mean Wt. (g) of Attached Algae |
|-------|--------------------------------|
| 1 | 0.42 ^{ab} |
| 2 | 0.20 ^a |
| 3 | 0.42 ^b |

Note. Block 1 – Oton Beach, Iloilo; Block 2 – Villa Beach, Iloilo City; and Block 3 – Molo Beach, Iloilo City.

7 RECOMMENDATIONS

Based on the findings and conclusions, the following are recommended: use of treatment A (80% golden apple snail egg extract and 20% ordinary paint) as an antifouling agent against algae; further studies should be conducted to validate the results; other species of snail eggs to be used as an additive to paints; the egg extract must be tested to other fouling organisms; and more arrays of marine organisms must be tested in toxicity test.

REFERENCES

- [1] EMB Region 6. *Ambient Water Quality Report Annual*. [online]. 2015. Available from: r6.emb.gov.ph/wp-content/.../AWQAR-Annual-2015.docx.
- [2] Brunn, K. *Algae can Function as Indicators of Water Pollution*. [online]. 2012. Nostoc Algae Laboratory. Available from: <http://www.walpa.org/waterline/june-2012/algaecan-function-as-indicators-of-water-pollution/>.
- [3] Corrosionpedia. *Fouling Organism* [online]. 2018. Available from <https://www.corrosionpedia.com/definition/541/foulingorganism>.
- [4] Dreon, M.S., Frassa, M.V., Ceolin, M., Ituarte, S., Qiu, J-W., Sun, J., Fernández, P., and Heras, H. *Novel Animal Defenses Against Predation: A Snail Egg Neurotoxin Combining Lectin and Pore-forming Chains that Resembles Plant Defense and Bacteria Attack Toxins* [online]. 2013. Available from <https://doi.org/10.1371/journal.pone.0063782>
- [5] Gopikrishnan, V., Radhakrishnan, M., Pazhanimurugan, R., Shanmugasundaram, T., and Balagurunathan, R. Natural products: Potential and less explored source for anti-fouling compounds. *Journal of Chemical and Pharmaceutical Research*, 2015, Vol. 7, nr. 7, pp. 1144-1153.

- [6] Hellio, C., Lebret, K., and Thabard, M. *Algae as Marine Fouling Organisms: Adhesion Damage and Prevention* [online]. 2009. Available from: https://www.researchgate.net/publication/263088564_Algae_as_marine_fouling_organisms_Adhesion_damage_and_prevention.
- [7] International Maritime Organization. *Antifouling Systems* [online]. 2003. Available from: <http://www.imo.org/en/OurWork/Environment/AntifoulingSystems/Documents/FOULING2003.pdf>
- [8] International Rice Research Institute. *Golden Apple Snails* [online]. 2017. Available from: <http://www.knowledgebank.irri.org/step-by-step-production/growth/pests-and-diseases/golden-apple-snails>.
- [9] New Pest Advisory Group. *NPAG Data: Pomacea canaliculata - Golden Apple Snail* [online]. 1998. Available from: <http://www.pestalert.org/storage/Molamppc598.pdf>.
- [10] Organisation for Economic Cooperation and Development Guideline for Testing of Chemicals (OECD). *Algal Growth Inhibition Test* [online]. 1984. Available from: www.env.go.jp/en/laws/chemi/cscl/CSCL_test1.pdf.
- [11] US Naval Institute. *Marine Fouling and Its Prevention* [online]. 1952. Available from: www.vliz.be/imisdocs/publications/224762.pdf.
- [12] Vidyasagar, A. *What are Algae* [online]. 2016. LiveScience. Available from: <https://www.livescience.com/54979-what-are-algae.html>.

CHALLENGES AND OPPORTUNITIES FOR ENHANCING PORT COMPETITIVENESS IN AFRICA

Akram S. Elsemy^[1], Alaa M. Morsy^[2] and Mohamed E. Abdel Aziz^[3]

- 1) Professor of Coastal Engineering and Port Planning, Dean, Port Training Institute, Arab Academy for Science, Technology, & Maritime Transport
- 2) Associate Professor of Structural Engineering, Assistant Dean, Port Training Institute, Arab Academy for Science, Technology & Maritime Transport
- 3) Lecturer of Ports Simulators, Head of Researches & Development Dept., Port Training Institute, Arab Academy for Science, Technology, & Maritime Transport

Keywords: Hubs, emerging ports, opportunities, Investments, SWOT.

Abstract: Throughout the eras, Africa is considered to be one of the most important economic treasures which were never well utilized despite the great potentials that qualify Africa to become an important and effective element in the global trade exchange. However, the significant growth in African Gross Domestic Product (GDP) and the developments in the maritime and logistics industry could give us very good indicators towards a promising future. There are many integrated strategies must be taken into consideration to achieve effective investments in such sector.

The research aims to highlight important elements that help to study the prospects of developing the maritime industry and logistics in Africa. Based on the research outputs we could conclude that Africa maritime and logistics sector is encouraging to play a significant role in handling logistics activities associated with international trade. Thus cooperation in improving the efficiency of shipping and related logistics activities besides developing the human resources through capacity building and establishment of a job skills guideline that based on the global stander can have a positive and significant influence in boosting trade flows.

Overall global investments for a good shipping service with regular trade vessels, particularly container carriers, is highly needed as a promising opportunity for the investors and economic entities in the field of maritime and logistics industry.

1. INTRODUCTION:

Africa occupies an area of 30,370,000 km² with a population of 1,220,000,000 and 36,4/km² population density, thus Africa covers about 6% of the earth's total surface. Today,

the region's economic outlook is rather promising as the regional GDP increased to grow by 0.8% in 2017.

There are also signs of improvement in the quality of growth: During the 2000s, Africa's labor productivity increased by close to 3%, almost half of which was attributed to workers moving to new activities with higher productivity. This is very important: productivity enhancement is what sustains economic growth in the longer term [1, 2].

In accordance of the international trend of globalization and the tendency to open global horizons to enhance the movement of world trade, particularly in the area of maritime transport, Africa remains one of the most important opportunities to be exploited to become a key partner in this direction.

The continent of Africa is strategically located in the middle of the world continents and is strongly qualified to occupy a significant position in world trade map if this unique location is well exploited as well as natural and geographical resources.

Africa has a coastal nature and many natural ports on its eastern and western borders whereas more than 30 states of the 05 are coastal states which handle 6% of the worldwide water-borne cargo traffic and about 3% of the world's container traffic.

Africa ports and logistics has unexploited advantages at the optimum level such as location close to major world or regional shipping routes, leading to minimum deviation from that shipping route, Land area available for cargo storage and/or value adding activities; and sufficient depths in approach channel and the port and the possibility to increase the depth if required.

2. RESEARCH OBJECTIVES:

This research will focus on the opportunities for global maritime and transport investment towards enhancing African ports competitiveness on the international maritime map as well as challenges facing the development and integration of ports and logistics in Africa.

The research also aims to highlight important elements that help to study the prospects of developing the maritime industry and logistics in Africa such as: the ability of African ports to receive global investments, the qualification of Africa to enter the era of smart ports, the eligibility of Africa for sustainable development, and the effect of the flow of investment on the change in maritime transport legislation in the continent. The research also focuses on the opportunities for global maritime and transport investment towards putting Africa firmly on the international maritime map as well as challenges facing the development and integration of ports and logistics in Africa.

3. METHODOLOGY:

Based on classification of African ports and logistics all over the convenient into three main classes Pivotal zones (hubs), Emerging ports, promising ports and SWOT analysis could obtain a brief study for the Challenges and Opportunities for Enhancing Port competitiveness in Africa as well as proposed methods for enhancing African ports competitiveness as shown in (Figure 1).

Africa is a continent that has sixty ports and more than half of its ports are located in East and West Africa. East and West African ports are ports that play an important role in the World trade, as an important percentage of the World trade, transit through these ports. They are also considered as economic lungs for the countries they belong to, due to the amount of money they generate. Becoming efficient is an absolute objective that was fixed by every port in these two regions in order to attract more vessels, at the same time increase the revenues. These two regions are considered by many investors as the two biggest markets in Africa, due to the number of their population and the fast growth of the gross domestic product of the countries belonging to these regions.

However, we could identify three main pivotal hubs which basically connect Africa with the world which are represented in (Port of Durban - South Africa, Tanger-Med - Morocco and Suez Canal Zone - Egypt). Such classification based on many factors such as volume of cargo handling, logistics facilities, geographic location, and the connection with land-lock countries in Africa as well as the rate of development and investment opportunities.

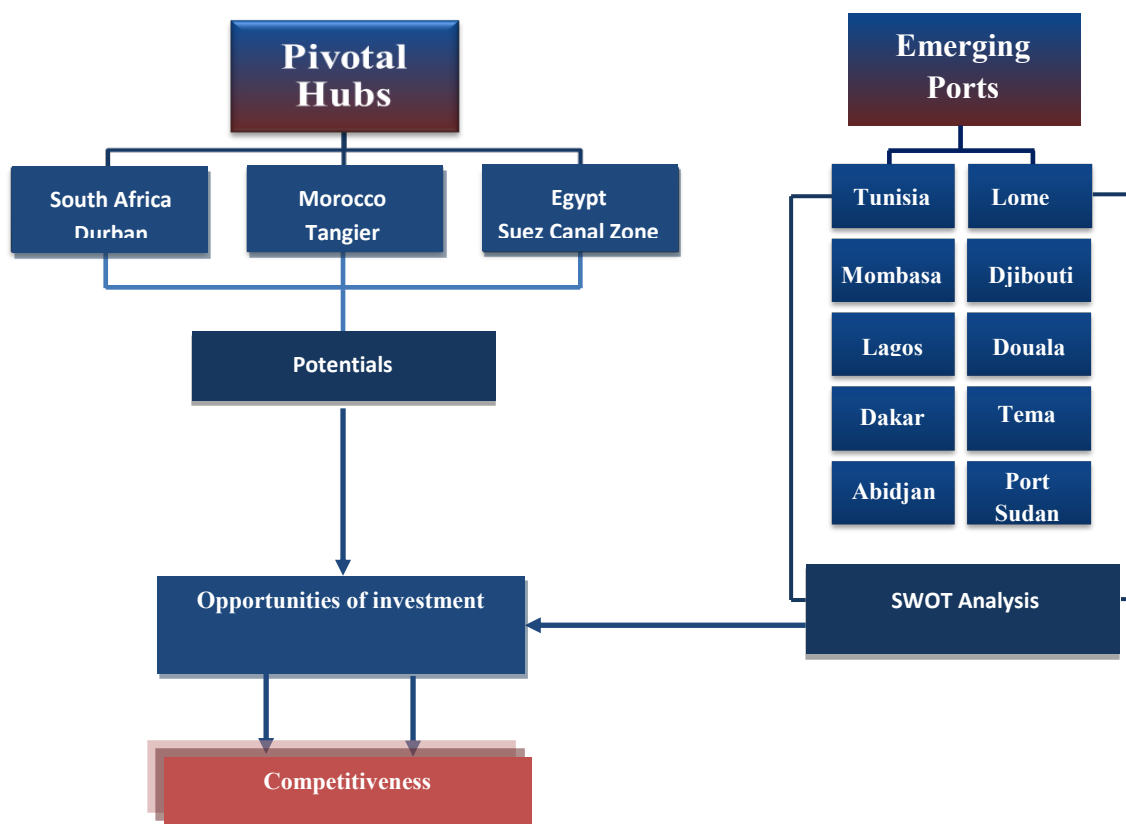

Figure 1 "Enhancing African Ports Competitiveness"

4. PORT COMPETITIVENESS IN AFRICA:

The research studies the importance and effectiveness of the below mentioned pivotal hubs on which Africa relies as a cornerstone points for its trade exchange which are mainly Suez

Canal (Egypt), Tangier-Med (Morocco), and Port of Durban (South Africa), as well as The Emerging Ports in the north, east, and west of Africa, in addition to study the human recourses, logistics , information technology and opportunities for sustainable development as an important factors to identifying the challenges and opportunities for investment and development [17, 18].

4.1 Pivotal hubs

According to the Geographic location, cargo handling rate and development projects, Port of Durban, Suez Canal Zone, Tangier-Med could be represented as the most important and effective pivotal hubs in Africa as shown in "Figure 1".

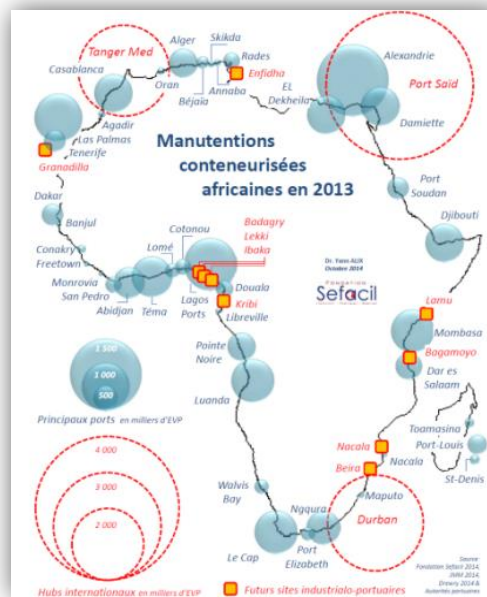

Figure 1 "Busiest Ports & Pivotal Hubs in Africa"

Port of Durban - South Africa:

Durban is the main southern Portal of Africa. It is one the largest port in Africa, Durban is considered to be the busiest port in South Africa and generates more than 10% of revenue. It is the second largest container port in Africa (after Port Said in Egypt) and it is the fourth largest container port in Southern Hemisphere. (First is Jakarta in Indonesia, second is Surabaya in Indonesia, and third is Santos in Brazil).

The distance around the port is 11 kilometers (13 miles) with Rail tracks total of 302 kilometers (188 miles) and the port has 68 berths which are operated by more than 20 terminal operators with Over 400 commercial vessels call at the port each year. The Port of Durban is South Africa's premier port and hub of the region, especially for the Johannesburg (Gauteng Province) area.

As the current port is not sufficient to deal with the recent demand for capacity, the focus is on the development of a new port in the immediate vicinity of Durban. The Durban-Dig-Out port (extension) is designed to cover an annual total container production of 1,000,000 TEUs, an annual liquid annual production rate of 2,000,000 kg and 300,000 vehicles annually. The Ruling Vessel is a container ship with a capacity of 22,000 TEUs, 230 meters long, 33.5 meters wide and 16.3 meters. The check for the TEU design vessel is reviewed 22,000. Based on global developments in shipbuilding and a quick look at developments in container trade in South Africa, it was concluded that the 22,000 TEU vessel is recommended for port design [6].

Suez Canal Zone - Egypt

Suez Canal Zone is one of the most heavily used shipping lanes in the World (8% of the World's seaborne trade) as it is the shortest route between the sub-Indian continent and Asia-Pacific Region with the markets of Europe and North Africa which allows significant saving cost for the vessel (time and logistics costs), Interval between ships: 10-16 min (2-3 kilometers). The New Suez Canal Project shortens the transit time from 14 hours to 11 hours. The monthly number of vessel: 1,411 (Jan 2010).

The Suez Canal Zone Spanning 161 km², almost two-thirds the size of Singapore, it consists of two integrated areas (Ain Sokhna with Ain Sokhna Port, East Port Said with East Port Said Port), two development areas (Qantara West, East Ismailia) and four ports (West Port Said Port, Adabiya Port, Al Tor Port and Al Arish Port). Concerning the Integrated areas, each integrated and developed area provides investment opportunities in industrial and commercial enterprises, infrastructure and real estate development, logistics, amenities and state-of-the-art technology. Planned port expansions will increase the capacity for handling maritime traffic and for offering related services such as ship building, stevedoring, bunkering, vessel scrapping and recycling.

Tangier-Med - Morocco

Tangier is considered to be the north-western capitol for Africa and the major maritime transport link of North and West Africa countries with Europe and America. Tangier consists of 2 ports Tangier Med 1, and Tangier Med 2.

Tangier Med 1: represents 1,6 km of container docks at (-16.0) and (-18.0) meters, 2,6 km of dikes and 140 hectares of land, of which 80 hectares for container traffic with capacity of 3,000,000 containers, served by rail as well in addition of 2 petrol stations.

Tangier Med 2: 2,8 km of container docks at (-16.0) and (- 18.0) meters, 4,8 km from dikes and 160 hectares of land totally won over the sea with capacity of 2,200,000 containers in addition of 2 optional oil stations .

4.2 Opportunities of investment in pivotal hubs

According to the World Ports Sustainability Program (WPSP) which has been launched in Antwerp March-2011 [7], there is a high need to enhance the main following fields in such hubs to ensure the international competitiveness 2030:

- Resilient infrastructure (Port Planning – PPP – Digitization and automation – Ecosystems Management).
- Climate and Energy (Energy efficiency – Circular economy – Bio-based economy – Clean ship incentives – deployment of alternative transport fuels).
- Community outreach and port-city dialogue.
- Safety and Security.
- Governance and ethics.

These fields are already being maximized by creating investment opportunities in infrastructure, IT, supply chains clusters and integrated logistics areas currently being established, however still high need for attention to enhance environmental projects in ports and alternative energy besides maximizing the role of skills guide line concerning capacity building .

Overall, Africa with the recent projects is improving its potential to enhance the flow of trade delivered to Europe, Asia and America through the Pivotal Zones in South Africa, Egypt and Morocco.

4.3 Emerging ports SWOT analysis

During the recent years, many African countries have adopted new plans for the development/ construction of port and logistics infrastructure as a key factor for polarization of international shipping agencies and increasing trade and investment, such as Tunisia (Tunisia), Lome (Togo), Djibouti (Djibouti), Mombasa (Kenya), Abidjan (Côte d'Ivoire), Tema (Ghana), Douala (Cameroon), Lagos (Nigeria), Dakar (Senegal), etc [14,15].

Challenges and Opportunities for Enhancing Port competitiveness in Africa could be expressed through a SWOT analysis as well as proposed methods for investment for enhancing African ports competitiveness.

Strengths:

There are several potentials for Eastern and Western African emerging ports which qualify them for a promising future in the case of good exploitation, and leads to increased productivity and global competitiveness in general .Such natural potentials could be represented in: deep water ports on the West and east African coast that can accommodate 3rd generation ships, promising Efficiency for Sustainable Development, ports with a distinct Central location are eligible to be important pivotal ports such as Djibouti and Lagos, and Promising efficiency of customs and border management clearance besides, the eligibility to attract more shippers, carriers and cargo owners [16].

Weaknesses:

There are also some weaknesses that impede the development process in these emerging ports, however, the accessibility is affordable and could accelerate the development process such as: Separation between ownership and management, Absence of marketing policy as well as Low services & port operations performance rates and Lack of advanced storage facilities in terminal. Also, there is a high need for information sharing & Technology,

improvement of the customs procedures to match with the landlocked countries, advanced storage facilities in terminal. But the most effective weakness could be detected is the Lack of sustainability policies and procedures and high need of skills guideline concerning training and capacity building [10].

Opportunities of Investment:

Overall African emerging ports have a natural potential to attract more ports and terminals agencies, shippers, carriers and cargo owners in term of international shipments and attract more ships in terms of Life Space Crisis Intervention (LSCI). Also, Africa has natural potentials and recourses to investigate in Sustainable Development such as alternative energy and Port and inland infrastructure focusing on the transport services (including roads, ports, and airports). Moreover Intelligent & technology in Eastern and Western ports, integrated automation terminals, and fisheries industry are very effective opportunities of investment Ultra Large Container Vessel 10,000 TEUs will soon have potential ports in West Africa to handle such vessels which is a very good indicator for promising maritime investment [11].

Threats:

Main threats facing the development process in ports could be represented in: high need of skills guideline concerning training and capacity building, Lack of sustainability policies and legalization, and inadequately funded Highway and Suburban Roads maintenance in some Areas of and landlocked countries.

◦. PROPOSED METHODS FOR ENHANCING AFRICAN PORTS COMPETITIVENESS

As a result, enhancing African ports competitiveness depends on the development and investment in the following four main factors

1- Infrastructure and Logistics

With a significant increasing number of vessels and terminals lining all over the world, African ports need to increase their market positions and stay competitive. Such competitiveness could not be enhanced without the investment in the logistics sector as:

- Container terminals, Utilities and services.
- Car terminal zones.
- Storage, dry bulk terminals.
- Multipurpose terminals.
- Fishing zones, Logistics zones.
- Supply Chain Clusters.
- Development of the port access roads.

٢- Information Technology

Information technology and sharing data are one of the most important main key factors for competitiveness, therefore investment and development in the following elements is the gateway for enhancing competitiveness and ensuring connectivity of African ports with the latest global trends and activating sustainable development.

- Existing of Single Window for Port Community System which will accelerate applying IT in new sectors like Dry Ports and Container Terminals Which Affect Positively the Trade between Africa and Europe.
- Existing IT systems in Western African Port are expected to facilitate propagating IT solutions in the remaining activities in the port.
- New systems that could be introduced for the newly developed activities with Europe and integrating them with existing systems.

٣- Sustainability

One of the major obstacles to sustainable development in the maritime and logistics sector in Africa is the environmental problems and ballast water management which are negatively affecting integration with European ports.

There is a High Need for:

- Environmental Systems Auditing for Ports e.g. "PERS" certification.
- Environmental Awareness especially in the Maritime Sector.
- Complete solutions for ballast water management and Consultancies.
- Applying Environmental Checklists in ports and stakeholders to be ingenerated with the international maritime environmental systems especially of Europe.

٤- Building Capacity:

The objective of the capacity building and training activities is to create, enhance and develop constituent capacity at industry level to design, implement and supervise port development training and maritime security scheme [١١].

- Upgrading /improvement of skills/knowledge training courses & programs.
- Developing skills guideline according to recent maritime international requirements.

٦. CONCLUSION AND RECOMMENDATIONS

Africa maritime and transportation sector has a significant role in handling logistics activities associated with international trade. Thus improving the efficiency of shipping and related maritime and logistics activities can have a positive and significant influence in boosting trade flows.

Having a good shipping service with regular trade vessels, particularly container carriers, with an adequate frequency to reduce waiting times and costs.

There is an urgent need for the establishment of a job skills guideline based on the global standers for port and logistics operation and to create an international standardization of training in Africa.

REFERENCES:

- [1] World Bank (2013). Countries' economic outlook. www.worldbank.org.
- [2] Elizabeth D. Beatriz, et al, "Urban-rural disparity and urban population growth A multilevel analysis of under-5 mortality" in 2013 sub-Saharan African countries, 2013.
- [3] USMAN GIDADO "Consequences of Port Congestion on Logistics and Supply Chain in African Ports", Lagos, Nigeria, 2010.
- [4] George Kobina et al, "Assessment of Port Efficiency in West Africa Using Data Envelopment Analysis", March 2010.
- [5] Steeneken, S., De Haan, F., De Koning, R., Gijsman, R., and Le, T. "The Durban Dig-out Project Report", TU Delft, Faculty of Civil Engineering and Geosciences 2014.
- [6] World Ports Sustainability Program [https](https://www.worldportsustainability.com), Antwerp 2018.
- [7] M.Kourouma, "The case of transport and trade facilitation in East Africa. Challenges and the way forward" UNECA / SRO-EA. Dares Salaam Tanzania. 2010.
- [8] Dago Alain Gohomene, "The Attractiveness of Ports in West Africa" Wiley Periodicals, 2016.
- [9] Lynn Harris, "sea ports and sea power: African Maritime cultural landscape", Springer International, 2017.
- [10] Tongzon, J., et al "Port choice in a competitive environment: from the shipping lines perspective." Applied Economics, 2012.
- [11] Christian Burger, "The Concept of Capacity Building, Safe Seas" Bristol Univ., 2017.

CONTAINERSHIP BAY TIME AND CRANE PRODUCTIVITY: ARE THEY ON THE PATH OF CONVERGENCE?

SHMUEL YAHALOM*, CHANGQIAN GUAN†

*Department of International Trade and Transportation
State University of New York Maritime College
6 Pennyfield Avenue, Throggs Neck, New York 10465
E-mail: yahaloms@aol.com, syahalom@sunymaritime.edu

†Department of Marine Transportation
United States Merchant Marine Academy
300 Steamboat Road, Kings Point, New York 11024
E-mail: cguan68@gmail.com

Keywords: Containership bay time, gantry crane productivity, stowing plan, beam size, port time, berth time.

Abstract

Containerships are getting bigger. Their time at the pier for discharge and load (D&L) is increasing due to larger bays. Bay time depends on gantry crane (crane) productivity (lifts/hour) of D&L. A match of vessel bay time growth and gantry crane output growth keeps containership bay time constant. Thus, are they on the path for convergence?

The paper shows the growth of containership bay time and crane productivity to determine their long-term relationship, using the containership bay time model developed by the authors. The paper quantifies crane productivity and bay time performance, showing their behavior for different vessel classes and long-term trends indicating no convergence. After redefining the crane output, the paper proposes that convergence is possible. The paper also shows that the slow growth of crane productivity encouraged D&L alternatives such as alternate and partial stowing, new D&L technologies (new spreaders, Fastnet) and increases in the number of ports of call to keep D&L time of large vessels efficient.

1. INTRODUCTION

In 1996 the first Post Panamax Regina Maersk of 6,418 TEU (Twenty Foot Equivalent Unit) was introduced. In 2015 the Ultra Large Containership MSC Oscar of 19,224 TEU was launched. The top two containership size categories, Very Large Containership and Ultra Large Containership, are expected to increase in numbers fastest for the next three years, 12.8% and 40.4%, respectively [1]. A series of 20,000 TEU-plus are on order by several shipping lines. The trend of increasing vessel size is to achieve economies of scale

at sea, obtain the lowest possible unit cost of container transport and stay competitive.

The increase in containership size is in length, beam, and height. A comparison of containership classes shows that an increase in ship length is not proportional to the increase in ship capacity, and the size of each cargo bay (bay) is much larger. Hence, the number of containers a gantry crane (crane) handles per bay is much larger with an increase in vessel class, i.e., diseconomies of scale in port due to the increase in bay size.

With the present technology, only one crane is working on one bay at any given time. The amount of time it takes to load and discharge (D&L) the largest bay is the basic measuring unit determining bay time for containerships [2]. Crane productivity, defined as lifts/hour (one lift equals one container), of D&Ling the largest bay determines the minimum amount of time it takes to complete it.

The paper's objective is the analysis of D&L time of a containership bay, focusing on the relationship between the two key factors, containership bay size and crane productivity. The results determine minimum bay, berth and port times. After a literature review, the methodology analyzes the relationship between the key variables. The analysis indicates that with the increase in beam size, the vessel's bay size increases. But crane productivity (lifts/hour) is lagging in its growth to match the bay increase in size. The inequality between the two increases the vessels' bay, berth and port times (diseconomies of scale), requiring new D&L technology, multiple ports of call and stowing plans.

2. LITERATURE REVIEW

The literature review is for containership liner service port time and port productivity. The review found little detailed relationship between berth time and crane productivity. Yahalom and Guan [2] indicate that bay time dominates berth time and ultimately port time. Cullinane, et.al. [3] identify port time as a schedule-planning instrument and the consequences of deviating from it. Jordan [4] addresses different D&L technologies to improve crane productivity. Duponcheele [5] discusses a new "double boom" concept of crane to improve productivity. Oliveira Moita and Caprace [6] study the effects of loading conditions and crane assignments on container terminal performance. Cullinane, et.al. [7] indicate that a ship's overall performance should take into account the entire voyage, not only sea time. They also indicate that port time is affected by cargo exchange, crane density, average crane productivity, down time in port, and working schedule. Gilman [8] mentions port time as a handling performance measure. Vulovic [9] is concerned that the port industry does not match large ship needs of minimizing port time. Ducruet, et.al. [10] address the time factor in port performance and efficiency for container vessels, addressing port time in the same way as Moon and Woo [11], who include congestion as a component of port time. Suarez-Aleman, et.al. [12] show that "port time is the combination of ... port access time, D&L times, ship waiting time, and time for customs ..." Christa, et.al. [13] addresses extended port time, the rationale of using big ships and the need for making up lost port time with higher speed. Tozer [14] discusses port time with respect to differences in vessel size, annual costs and the number of annual voyages. Cullinane, et.al. [15] address the economies of scale of large ships and port productivity improvements on diseconomies of scale in port. McLellan [16] indicates that there are practical limits to ship size that can be imposed on a port, including draft, space, container handling technology, and infrastructure. Brett [17] refers to a Drewry Insight study, indicating that "while overall berth productivity improves with larger vessels, it does not increase in line with vessel

sizes.” These findings indicate diseconomies of scale in port due to increasing ship size.

The literature review does not address the focus of the study, the link between bay time and crane performance, the key of understanding containership berth, and port times.

3. METHODOLOGY

The objective of terminal operators and shipping lines is to minimize containership berth time, defined as the time between vessel docking and undocking. Berth time is derived from bay time, which is defined in this paper as the amount of time it takes to D&L the largest fully loaded bay of a containership.

There are many bays on a containership. The longer the containership, the more bays. The largest bay stows the largest number of containers. With the present technology, one crane works one bay at a time. Assuming an unlimited number of cranes that can work on all cargo bays at once, the dominating factor of completing the D&L of a vessel is bay time. Bay time is calculated by bay carrying capacity divided by crane productivity.

In reality a crane blocks at least two bays [18]. Therefore, the minimum amount of time to D&L of a containership is two times the time it takes to complete the largest bay. Since most container terminals do not have enough equipment to assign the maximum number of cranes to a containership, it increases the containership time at the berth as well.

Containership bay time (the focus of the paper) is determined by containership bay holding capacity (B_i) and crane productivity (P) (lifts/hour) (Yahalom [2]). Since a bay is D&L'd, bay time is two times the time it takes to only discharge or load a bay, counting every container move as one lift each (Equation 1).

$$B_{it} = \frac{2B_{ic}}{P} \quad (1)$$

Where:

B_{it} is bay time (in hours).

B_{ic} is the number of containers (20ft and/or 40ft) in a bay, times 2, due to D&L.

P is crane productivity measured in container lifts/hour.

Equation 2, derived from Equation 1, is the percentage change in each of the variables in Equation 1.

$$\log B_{it} = \log 2B_{ic} - \log P \quad (2)$$

Equation 2 is the foundation for the determination of the relationship between bay time and crane productivity and their implications, as discussed below.

4. BAY SIZE, CRANE PRODUCTIVITY AND BERTH TIME

Bay time is the basic variable and measure determining a containership time at berth and ultimately at the port. It is calculated from bay size and crane productivity.

4.1 Bay Size

Bay size increases with beam size when containerships increase in size. Bay capacity is measured by the number of container slots, 20ft and/or 40ft standard ISO (International Organization for Standardization) containers, below and above deck. One 40ft slot equals two 20ft slots, and one 40ft bay is comprised of two 20ft bays. For example, from the Post Panamax Plus (Regina Maersk) to the Triple E (MSC Oscar), the beam size increased from

141ft to 194ft, respectively; from 241 40ft container slots per bay (15 tiers and 17 rows) to 396 40ft container slots per bay (18 tiers and 23 rows), respectively.

Bay size increase is consistent and predictable with the increase of containership beam. A beam's increase is a multiple of a container width of 8ft [2], which was the trend for decades with each launching of a new containership vessel class. Hence, the number of potential containers stowed in a bay increases accordingly.

4.2 Crane Productivity

Twenty years ago gross crane productivity was 20 to 24 lifts/hour. This productivity includes the time for hatch and crane movements and other disruptions. Net productivity omits the time of these two from the calculations. Today the range is between 33 and 38 lifts/hour [19]. At a range of 20 to 38 lifts/hour the overall advance is 90%. Crane lifts/hour is an established standard used for comparing crane productivity by ports and vessel class.

In general, crane productivity calculation is not constant because there are a number of factors to consider. On board a containership, hoisting and trolleying distances and speeds to D&L depend on containership class and the container location in the bay. The further the distance and the lower the container below deck, the longer it takes to D&L.

4.3 Relationship between Bay Size, Crane Productivity and Bay Time

Equations 1 and 2 are the foundation for determining the relationship between bay size and productivity in order to obtain the bay time. The analysis includes:

1. Required crane productivity to meet a constant bay time
2. Required bay time when crane productivity is a constant

These two are the basis of: identifying the range to leverage investments, motivating new R&D, guiding contract negotiations between shipping lines and ports, improving operations by training, and developing local, regional and national policies.

4.3.1 Constant Bay Time

A liner service operations is a planned service schedule for all the ports of call, including the containership berth time in each port. These times are a part of the contract between the container terminal and the shipping line. Thus, Table 1 identifies the minimum productivity level by vessel class that would assure a bay time of 20 hours.

Table 1: Minimum Crane Productivity (lifts/hour) in 20 hours of Bay Time

| Containership class | Number of 40ft containers | Minimum productivity (40ft containers) | Number of 40% to 60% ratio* | Minimum productivity (40% to 60% ratio*) |
|---------------------|---------------------------|----------------------------------------|-----------------------------|------------------------------------------|
| Panamax | 262 | 13.10 | 367 | 18.34 |
| Panamax Max | 336 | 16.80 | 470 | 23.52 |
| Post Panamax | 396 | 19.80 | 554 | 27.72 |
| Post Panamax Plus | 482 | 24.10 | 675 | 33.74 |
| New Panamax | 612 | 30.60 | 857 | 42.84 |
| Post New Panamax | 756 | 37.80 | 1058 | 52.92 |
| Triple E | 792 | 39.60 | 1109 | 55.44 |

*The ratio of 20ft to 40ft containers is 40% to 60%, respectively.

Table 1 and Figure 1 indicate that the largest bay, with 40ft containers, for a Post Panama containership, requires a minimum of 19.8 lifts/hour to complete D&Ling the

largest bay in 20 hours. The aforementioned, when loaded with a mix of 20ft and 40ft containers, 40% and 60% respectively, would require a crane output of a minimum of 27.7 lifts/hour. Obviously, the number of lifts for wider containerships is larger.

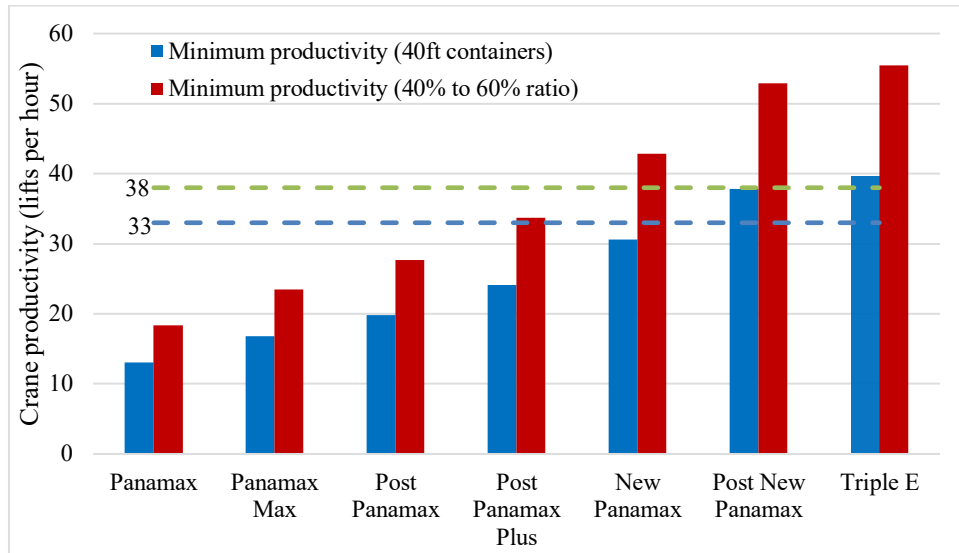

Figure 1: Minimum Crane Productivity (lifts/hour) in 20 Hours of Bay Time.

Assuming that the range of the number of container lifts/hour is 33 to 38, Table 1 and Figure 1 demonstrate that the Post New Panamax vessel class and smaller can complete their largest 40ft container bay in 20 hours. But for a mixed ratio of 40% 20ft and 60% 40ft containers, only the Post Panamax Plus class and smaller can complete the D&L operation in 20 hours. Obviously, other contractual time requirements would lead to other results.

4.3.2 Constant Crane Productivity

Containership bay time depends on crane productivity; at an average of 35 lifts/hour, the minimum bay time of the largest bay of a Post Panamax Plus with 40ft containers is 13.8 hours (Table 2). The same ship with a mix of 40% 20ft and 60% 40ft containers needs a minimum of 19.3 hours. Table 3 illustrates minimum bay time for D&L at different productivity levels, where the D&L with 40 plus lifts/hour is an illustration.

Table 2: Minimum Bay Time (hours) at a Given Crane productivity of 35 lifts/hour

| Containership class | Number of 40ft containers | Minimum time at bay (40ft containers) | Number with 40% to 60% ratio* | Minimum time at bay (40% to 60% ratio*) |
|---------------------|---------------------------|---------------------------------------|-------------------------------|-----------------------------------------|
| Panamax | 262 | 7.5 | 367 | 10.5 |
| Panamax Max | 336 | 9.6 | 470 | 13.4 |
| Post Panamax | 396 | 11.3 | 554 | 15.8 |
| Post Panamax Plus | 482 | 13.8 | 675 | 19.3 |
| New Panamax | 612 | 17.5 | 857 | 24.5 |
| Post New Panamax | 756 | 21.6 | 1058 | 30.2 |
| Triple E | 792 | 22.6 | 1109 | 31.7 |

*The ratio of 20ft to 40ft containers is 40% to 60%, respectively.

Ports are under stress to improve productivity due to beam size increases, and liner services need to meet multiport of call schedules. Owners/operators seek to maximize the

D&L in one port at a given amount of time, by modifying container stowing plans that expedite operations at the berth subject to each port's specifications and constraints.

Table 3: Estimated Bay Time (hours) for D&L of the Largest Bay by Containership Size (one bay)

| Containership class | Containers for D&L* | Productivity level (P) (lifts/hour) | | | | | | | | |
|---------------------|---------------------|-------------------------------------|------|------|------|------|------|------|------|------|
| | | 30 | 35 | 40 | 45 | 50 | 55 | 60 | 70 | 80 |
| Panamax | 367 | 12.2 | 10.5 | 9.2 | 8.2 | 7.3 | 6.7 | 6.1 | 5.2 | 4.6 |
| Panamax Max | 470 | 15.7 | 13.4 | 11.8 | 10.5 | 9.4 | 8.6 | 7.8 | 6.7 | 5.9 |
| Post Panamax | 554 | 18.5 | 15.8 | 13.9 | 12.3 | 11.1 | 10.1 | 9.2 | 7.9 | 6.9 |
| Post Panamax Plus | 675 | 22.5 | 19.3 | 16.9 | 15.0 | 13.5 | 12.3 | 11.2 | 9.6 | 8.4 |
| New Panamax | 857 | 28.6 | 24.5 | 21.4 | 19.0 | 17.1 | 15.6 | 14.3 | 12.2 | 10.7 |
| Post New Panamax | 1058 | 35.3 | 30.2 | 26.5 | 23.5 | 21.2 | 19.2 | 17.6 | 15.1 | 13.2 |
| Triple E | 1109 | 37.0 | 31.7 | 27.7 | 24.6 | 22.2 | 20.2 | 18.5 | 15.8 | 13.9 |

*The ratio of 20ft to 40ft containers is 40% to 60%, respectively.

4.3.3 Bay size growth, crane productivity growth, and gap analysis

Keeping bay time constant when bay size carrying capacity increases requires that productivity increase (lifts/hour) match the bay size growth (slots per bay) (Equation 3).

$$\log 2B_{ic} = \log P \quad (3)$$

The inequality between the two is due to bay size growing faster than productivity growth, i.e., increasing both the gap between them and the D&L time. Productivity growing faster than bay time growth closes the gap and decreases D&L time.

As noted, crane productivity increased from 20 lifts/hour to 38 lifts/hour, a 90% rise (Table 4 and Figure 3). Due to diversity in crane lifts/hour between ports and lack of records, the study increases every new vessel class launching by an average of three lifts/hour. Column 2 (Table 4) indexes productivity growth where Panamax is the base.

Table 4: Estimated Number of Bay Slots and Productivity Growth (lifts/hour)

| Vessel class | Number of 40ft slots per bay | Slots per bay growth (Panamax as base) (1) | Productivity (lifts/hour) | Productivity growth (20 lift/hour as base) (2) | Gap (1)-(2) | Ratio (1)/(2) (3) | Ratio with one lag (4) | Ratio with two lags (5) |
|-------------------|------------------------------|--------------------------------------------|---------------------------|------------------------------------------------|-------------|-------------------|------------------------|-------------------------|
| Panamax | 131 | | 20 | | | | | |
| Panamax Max | 168 | 28% | 23 | 15% | 13% | 1.88 | | |
| Post Panamax | 198 | 51% | 26 | 30% | 21% | 1.70 | 0.94 | |
| Post Panamax Plus | 241 | 84% | 29 | 45% | 39% | 1.87 | 1.14 | 0.63 |
| New Panamax | 306 | 134% | 32 | 60% | 74% | 2.23 | 1.40 | 0.85 |
| Post New Panamax | 378 | 189% | 35 | 75% | 114% | 2.51 | 1.78 | 1.12 |
| Triple E | 396 | 202% | 38 | 90% | 112% | 2.25 | 2.09 | 1.48 |
| Next generation | 436 | 233% | 41 | 105% | 128% | 2.32 | 1.93 | 1.80 |

During a similar time period, the largest bay carrying capacity of the Panamax and the Triple E increased from 131 40ft slots to 396 40ft slots, respectively, i.e., a 202% increase (Table 4 and Figure 3). Column 1 is an index of slot growth where the Panamax is the base.

Productivity and slots per bay growth are fact; their timing and adjusting lag are not clear. The focus is on the trend and magnitude of the gap (Figure 3). The timing and magnitude of the adjusting lag might be off, but their size and persistence are evident and were the cause of action to close the gap by the port and the container shipping industries.

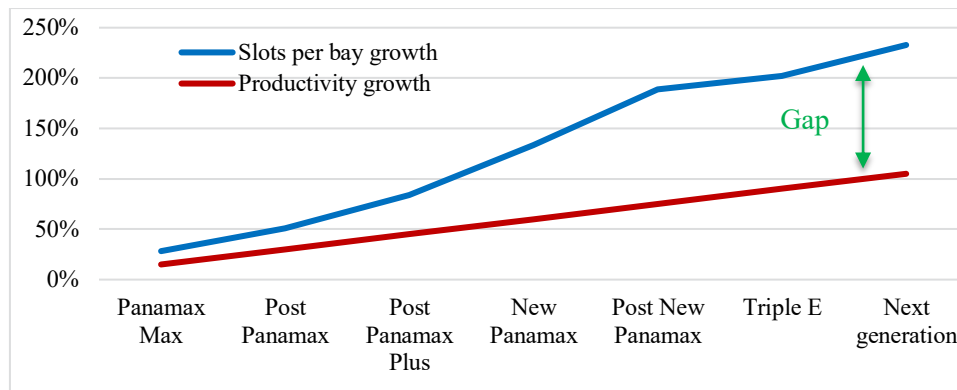

Figure 3: Slots per Bay Growth and Productivity Growth.

Closing the gap between bay capacity growth and productivity growth to stabilize bay time is a port industry's interest and duty (Table 4 "Gap" and Figure 3). For example, the Panamax Max with a 13% growth gap (Table 4, "Gap") caught up with the launch of the Post Panamax. Similarly, the productivity growth gap of the Post Panamax caught up when the Post Panamax Plus was launched. But then there was a setback because the New Panamax was launched (Table 4), and the gap opened again. Catching up to the gap shows that crane productivity improvements had a lag of at least one vessel class; in others, two vessel classes. In the one lag column (Table 4) the ratios are 0.94 and 1.14, nearly an equilibrium. The lag reduced the ratio greatly up to and including the New Panamax with a ratio of 1.40. But the trend in the lagged ratio increases (Table 4), reinforcing the trend and the gap identified above. Some of the gaps close with two or more lags (Table 4).

Converting the lag into time is difficult but it could be estimated at a range of four to seven years, the time it takes to plan and build a new vessel class.

5. CHALLENGES

Containership new builds are expected to increase beam size. The gap between bay capacity and crane productivity (lifts/hour) cannot be closed by increasing the number of lifts/hour alone, due to technical limitations. The gap and its growth forced the stakeholders to look for D&L time-saving solutions, new technologies and operation methods:

New Spreader Technology. The crane operators use spreaders that lift several containers at a time, i.e., two [20], three [21], four [22] and more. This new technology measures the output in moves/hour, not lifts/hour. For example, if all D&L lifts are of two containers or more (2 TEUs, 4 TEUs or 6 TEUs), bay time would be cut substantially.

Fastnet. "Fastnet" [23] addresses the present crane operations itself. It eliminates the present crane's wheel base from blocking two bays. Each bay is assigned a crane, assuming no limit of cranes on the pier. Fastnet closes or doubles the present crane output. Fastnet and the new spreader technology would increase output greatly and are expected to become the standard for the large containerships' operations in the large ports.

Stowing. Stowing planners provide options to reduce vessel stay at berth by stowing containers for the same port in non-adjacent bays to maximize crane use.

The methods identified above when fully implemented with an assigned crane per bay reduce bay time, berth time and ultimately port time.

6. CONCLUSION

Containership bay time increases with vessel beam size and constant crane output. This

link inherently causes diseconomies of scale at the port for wide vessels. The focus is on the relationship between the containership beam size, crane productivity (lifts/hour), and bay time. Comparing productivity and output (moves/hour) is key in studying port efficiency/expansion. The paper uses the standardized lifts/hour to measure, compare, quantify and highlight the extent of the problem and its consequences.

The pressure on the owner/operator is reduced by calling multiple ports and by creative stowing plans. The pressure on the ports is to improve productivity and output at the pier.

The paper finds that (1) the diseconomies of scale due to increase in containership beam and productivity (lifts/hour) are substantial and increasing. (2) The gap between the two is adjusting with a lag that does not converge. Hence, external measures to stabilize port performance, whereby output growth matches bay size growth, are needed. Stabilizing this link also requires a large number of cranes. Some short term advances could be by creative stowing and calling multiple ports. In the long-run spreaders with multiple-container lift technology and a Fastnet or similar technology (a large undertaking) are needed. Ultimately combining of these two might eliminate the diseconomies of scale in the port.

The research highlights container terminal operations, long-term terminal needs and the ability to compete. It could also be used for time and planning for bay, berth, stowage, and berth time guarantees during negotiations and for port development and investments.

REFERENCES

- [1] Alphaliner's monthly fleet statistics, October 2014.
- [2] Yahalom, Shmuel, and Changqian Guan. Containership Port Time: The Bay Time Factor, *Maritime Economics & Logistics*, ISSN: 1388-1973, December, 2016, pp 1-17.
- [3] Cullinane, Kevin and Mahim Khanna. Economies of Scale in Large Container Ships, *Journal of Transport Economics and Policy*, Vol. 33, Part 2, 1998, pp. 185-208.
- [4] Jordan, Michael A. Quay Crane Productivity, Lifetech Consulting Inc., November, 2002.
- [5] Duponcheele, Paul. High productivity with a new concept crane, *Container Handling*, September, 2014.
- [6] Moita João Vitor Marques de Oliveira and Jean-David Caprace. Effects of Loading Conditions and Quay Crane Assignments on Container Terminal Performance, *Pianc-Copedec IX*, 2016, Rio de Janeiro, Brazil.
- [7] Cullinane, K. and M. Khanna. "Economies of scale in large containerships: optimal size and geographical implications", *Journal of Transport Geography*, 2000, 8: 181-195.
- [8] Gilman, S., and G.F. Williams. The Economics of Multi-Port Itineraries for Large Container Ships, *Journal of Transport Economics and Policy*, May, 1976, pp. 137-149.
- [9] Vulovic, Rod. Changing Ship Technology and Port Infrastructure Implications, *In Proceedings of a Workshop Trend and Future Challenges for US National Ocean and Coastal Policy*, Washington, DC, Academic Press, 1999, pp. 59-64.
- [10] Ducruet, Cesat, Hidakazu Itoh and Olaf Merk. Time Efficiency at World Container Ports, *International Transport Forum*, OECD, August, 2014.
- [11] Moon, W. The impact of port operations on efficient ship operation: from both economic and environmental perspectives. *International Association of Maritime Economists (IAME)*, 2013, Marseilles, France.
- [12] Suarez-Aleman, A., Trujillo, L., and Cullinane, K. Estimating port efficiency through an alternative methodology: Time as an output of port efficiency. *International Association of Maritime Economists (IAME)*, 2013, Marseilles, France.
- [13] Sys, Christa, Gust Blauwens, Eddy Omeij, Eddy Van De Voorde and Frank Witlox. In Search of the Link between Ship Size and Operations, *Transportation Planning and Technology*, August, 2008, Vol. 31, No. 4, pp. 435-463.

- [14] Tozer, David and Andrew Penfold. Ultra-Large Container Ships (ULCS) designing to the limit of current and projected terminal infrastructure capabilities, *Lloyd's Register of Shipping*, 2001.
- [15] Cullinane, K., and Khanna, M. Economies of scale in large container ships. *Journal of Transport Economics and Policy*, 1999, 33 (2), 185–208.
- [16] McLellan, R.G. Bigger vessels: How big is too big? *Maritime Policy & Management* 24 (2), 1997, 193–211.
- [17] Brett, Damian. “New research shows port productivity does not increase in line with ship sizes,” *Lloyd's List*, March 23, 2015.
- [18] OECD/ITF. The Impact of Mega-Ships, International Transport Forum, 2015.
- [19] Konecranes, lifting business. Smarter Where it Matters, 2010, pp. 77.
- [20] Vetrikal, June 21, 2005, <http://www.vertikal.net/en/news/story/1645/>
- [21] Heavy Machinery Manufacturing, September 28, 2010.
- [22] Lind, Derrick, Jonathan K. Hsieh and Michael A. Jordan. Tandem-40 Dockside Container Cranes and Their Impact on Terminals, Liftech Consultants Inc., ASCE Ports 2007 Conference, San Diego, CA, March 25-28, 2007.
- [23] Productivity needs revolution, not evolution. *Port Strategy*, March 23, 2015.

OPEN-BERTH STRUCTURES' BED ROCK SCOUR PROTECTION SYSTEM FROM MAIN PROPELLER ACTION: CASE STUDY IN VIETNAM

Dr. Nguyen Thanh Son *

* Vietnam Maritime University
No. 484 Lach Tray street, Hai Phong city, Viet Nam
e-mail: nthson@vimaru.edu.vn, web page: <http://www.vimaru.edu.vn>

Keywords: Ship main propeller action, Scour, Bed rock protection layer, Open-berth structure

Abstract. The ship main propeller action is the one of biggest scour impacts to the bed rock protection layers of the berths, especially in the open-berth structures. Nowadays, while the ship size, capacity and characteristics tend to be increase more and more, the scour impact by the main propeller on the rock protection layer is more intense. These negative effects can impact considerably on the open-berth structure.

However, currently in Viet Nam, the design and calculation methods of the bed rock protection layers haven't considered the main propeller action yet. This matter can cause inadequate evaluations on impacts on the bed rock protection system.

The paper presents and analyzes the scour impact of the main ship propeller and discuss the protection solutions for the bed rock layers of the open-berth structure. As the result, the most effective and appropriate solution considering the main propeller action in Vietnamese conditions will be proposed and an example is also presented.

1 GENERAL

In the development countries, the bed rock protection system is designed and analyzed by considering adequately wave action, natural current, ship propeller, etc. Besides, scour protection solutions considering the main propeller action (e.g. rock fill, instu concrete, performance mattress, etc.) have been researched and presented. The calculation results achieved the high reliability and ensure the economic - technical efficiency.

In Vietnam, open-berth structures are being applied for ports most popularly. However, the design and calculation of the bed rock protection currently used in Vietnam have not considered the ship propeller action yet, i.e. only considering effects of waves and natural current.

Nowadays modern ships being built and installed power of the main propulsion system increase rapidly (from 90 up to 100,000 kW), their main propeller actions to the bed rock protection system of open berth are more significant and must be taken into consideration during the design process.

Especially during berthing and unberthing, eroding forces on the seabed in front of the berth or on the slope underneath the berth can be substantial. The ship propeller action causes

current velocities which can reach up to 8 m/s near the bottom. While, the tidal current is typically limited to around 1 or 2 m/s. The main propeller currents causes an induced jet current speed directly behind the propeller.

The scour to the solid berth structures is normally the scour of the material in front of the berth, whereas the scour to the open structure is often more complex, including:

- Scour around piles, especially at piles near the front of the quay;
- Scour of the slope underneath the berth structure, even up to the top

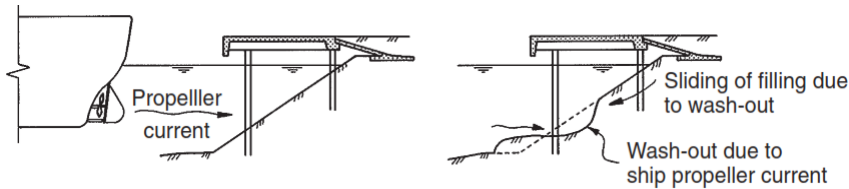

Figure 1: Scour impact to the berth by the propeller current

2 SCOUR DUE TO MAIN PROPELLER ACTION

The operation of main propeller can cause an induced jet current speed directly behind the propeller. The scour due to propeller action on the seabed in front of the berth is shown as follows:

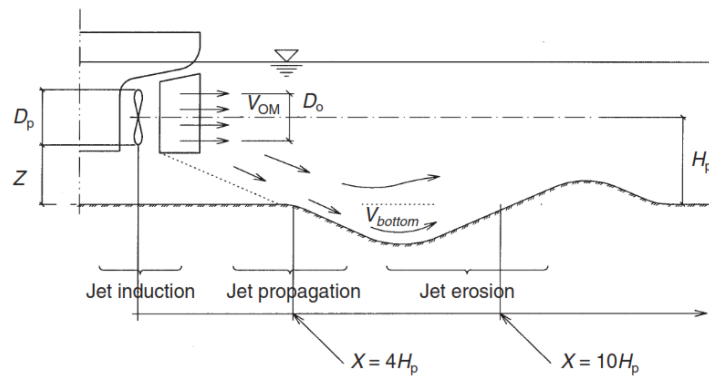

Figure 2: Scour of the seabed in front of the berth due to the action of a main propeller

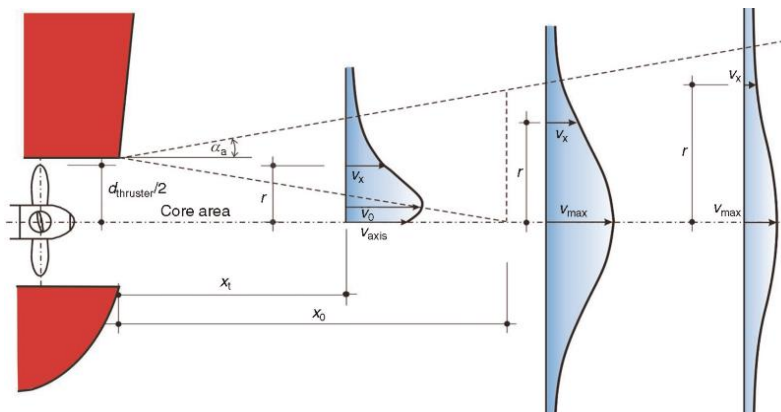

Figure 3: The velocity distribution of the current induced by a propeller

The main propeller action generates the current velocity which diffuses in a cone shape away from the propeller and decreases with increasing distance from the propeller. The maximum seabed velocity (V_{bottom}) is approximately in the range of distance $4 \times H_p$ to $10 \times H_p$ from the propeller (Figure 2).

The jet velocity generated by operating main propeller is called the "induced jet velocity" and occurs directly behind the main propeller. It is calculated by the following [6]:

$$V_{\text{OM}} = c \times \left[\frac{P}{\rho_0 \times D_p^2} \right]^{1/3} \quad (1)$$

In which, V_{OM} : initial centreline jet velocity from the main propeller (m/s); c : 1.48 for a free propeller or a non-ducted propeller, and 1.17 for a propeller in a nozzle or a ducted propeller; P : engine output power (kW); ρ_0 : density of seawater, $1.03 \text{ (T/m}^3\text{)}$; D_p : propeller diameter (m).

The bottom velocity can be calculated by using the formula below [7]:

$$V_{\text{bottom}} = V_{\text{OM}} \times E \times \left[\frac{H_p}{D_p} \right]^a \quad (2)$$

In which, $E = 0.71$ for a single-propeller ship with a central rudder, and 0.42 for a twin-propeller ship with a middle rudder; H_p : height of the propeller shaft over the bottom (m); $a = -1.00$ for a single-propeller ship and -0.28 for a twin-propeller ship.

3 THE REQUIRED STONE PROTECTION LAYER

The diameter of required stone to ensure stability against the propeller current can be calculate in the following formula [7]:

$$d_{\text{req}} \geq \frac{V_{\text{bottom}}^2}{B^2 \times g \times \frac{(\rho_s - \rho_0)}{\rho_0}} \quad (3)$$

In which, d_{req} : Diameter of required stone (m); V_{bottom} : Bottom velocity (m/s); B : Stability coefficient, $B = 0.90$ for ships without a central rudder, $B = 1.25$ for ships with a central rudder; g : Acceleration due to gravity, $9.81 \text{ (m/s}^2\text{)}$; ρ_s : Density of stone, $2.65 \text{ (T/m}^3\text{)}$; ρ_0 : Density of water, $1.03 \text{ (T/m}^3\text{)}$.

The formula is used to calculate the equivalent stone weight as follows [7]:

$$W = \frac{d_{\text{equ}}^3 \times \pi \times \rho_s}{6} \quad (4)$$

In which, W : Equivalent stone weight (kN); d_{equ} : Diameter of equivalent stone (m); ρ_s : Specific gravity of a block unit of stone, $26 \text{ (kN/m}^3\text{)}$.

The diameter and equivalent weight of required stone will decide in selecting components of protection filling layers seabed and slope underneath the berth.

4.2 Covering with reinforced concrete mattress

A progressive scour protection method being applied at some of the world's most advanced ports is covering with reinforced concrete mattress. The thickness of the protective layer can be applied more accurately with a thickness of 30 cm to 80 cm or more. The mattress is placed on the prepared slopes and sea bottom, joined together and pumped full of concrete then.

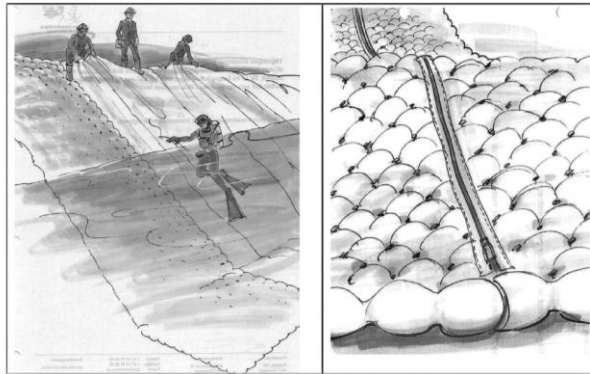

Figure 6: Construct to filling the concrete mattresses [5]

The mattresses supplied in the widths of 3.75 m and up to 100 m can be attached to panels in advance for rapid installation in the area to be protected. The thickness of the mattresses can be 7.5 cm up to 60 cm, with area weights, when filled with concrete of approximately 150 - 1200 kg/m². The mattresses used for berth protection are usually delivered with a thickness of at least 20 cm, to give an approximate weight of around 500 kg/m². The concrete be designed for pumping. When the concrete is pumped into the mattresses, it will cause the water to evacuate through the fabric. The individual mattresses should be connected by zippers. The concrete used to fill the mattresses must be suitable for pumping through a pipeline of 50 - 75 mm diameter.

The method of covering with reinforced concrete mattress can be considered as the advanced solution with its following advantages:

- The thickness of protection layer can be constructed more accurately.
- The linkage and uniformity of material is better and more stable withstand external forces such as wave actions, natural current, ship propeller, etc.
- The process of construction can be controlled better to ensure the uniformity and satisfaction of design requirements.

In case this protection method is applied in Vietnamese conditions, it also have some disadvantages as follows:

- The construction of underwater concrete is more complicated and expensive.
- The mattress production to ensure technical requirements and durability has not been yet available in Viet Nam.
- The construction of covering the empty mattress requires the high precision which is difficult to construct at where water level changes.
- This is a new method, so the current domestic technology is limited and need more time to study, transfer and apply.

- For open berth with piles, production and construction of mattress for pile net are very complicated. The process of pumping concrete into spaces between piles is so difficult to ensure uniformity.

As the above analysis, the bed stone scour protection is currently most commonly used in open berths in Viet Nam due to its convenience in construction especially with marine structures (constructed at the changeable water level), availability of materials and the ability to apply to many different types of berth and other conditions.

5 THE CASE STUDY IN VIET NAM

5.1 Introduction

The name of project: "Improve the infrastructure and the berth of the shipyard - 189 Co., Ltd."; its location: Dinh Vu-Cat Hai Economic Zone, Hai Phong City, Viet Nam.

Specifications of berth:

- Total length of berth: 190.00 m; Width of berth: 22.40 m; Top altitude: + 4.75 m ; Bottom altitude: -8.70 m; High design water level: + 3.75 m; Low design water level: + 0.80 m.

Design Ship Characteristics:

- Type of ship: Container vessel; Tonnage: 10,000 DWT; Length: $L_t = 141.00$ m; Width: $B_t = 22.4$ m; Laden draught: $T_c = 8.0$ m; Power output of main propeller: $P = 2.250$ kW; Diameter of main propeller: $D_p = 4.500$ mm. The main propeller propulsion system consists of twin propellers with central rudder.



Figure 7: Location of the berth of Company Limited 189 in Cat Hai - Dinh Vu Economic Zone

5.2 Calculate the bottom velocity of current by the main propeller

The initial centreline jet velocity from the main propeller is given by the formula:

$$V_{OM} = c \times \left[\frac{P}{\rho_O \times D_p^2} \right]^{1/3}$$

Where: c : 1.48 for a free propeller or a non-ducted propeller; P : engine output power (kW), $P = 2.250$ kW; ρ_0 : density of seawater, 1.03 T/m³; D_p : propeller diameter (m), $D_p = 4.5$ m
 $\Rightarrow V_{OM} = 7.05$ (m/s)

The bottom velocity can be calculated:

$$V_{\text{bottom}} = V_{OM} \times E \times \left[\frac{H_p}{D_p} \right]^a$$

Where: $E = 0.42$ for a twin-propeller ship with a middle rudder; H_p : height of the propeller shaft over the bottom (m), $H_p = 3.55$ m; $a = -0.28$ for a twin-propeller ship
 $\Rightarrow V_{\text{bottom}} = 3.16$ (m/s)

5.3 The required stone protection layer

The diameter of the required is calculated by the following formula:

$$d_{\text{req}} \geq \frac{V_{\text{bottom}}^2}{B^2 \times g \times \frac{(\rho_s - \rho_0)}{\rho_0}}$$

Where: d_{req} : required diameter of the stone (m); B : stability coefficient, $B = 1.25$ for ships with a central rudder; g : acceleration due to gravity, 9.81 m/s²; ρ_s : density of stone, 2.65 T/m³; ρ_0 : density of water, 1.03 T/m³

$\Rightarrow d_{\text{reg}} = 0,4$ (m)

The corresponding weight of the stone is given by:

$$W = \frac{d_{\text{equ}}^3 \times \pi \times \rho_s}{6}$$

$\Rightarrow W = 0,1$ (T)

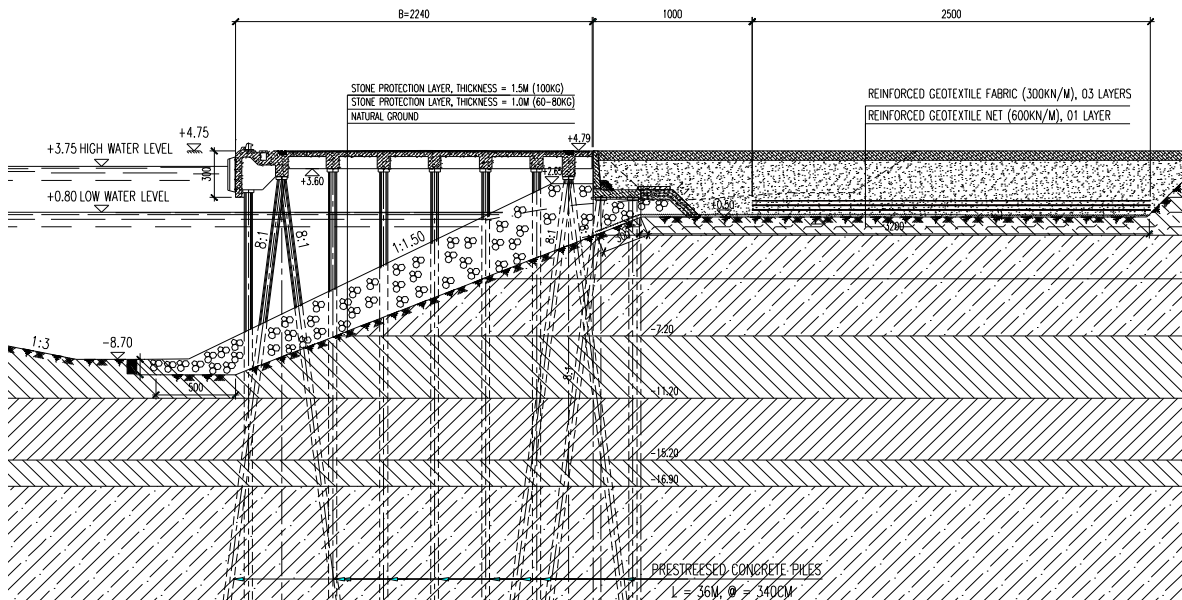

Figure 8: Cross Section of the berth and its bed rock scour protection layers

Based on the above calculation results, the bed stone protection system underneath of the berth is designed as follows:

- The minimum required stone size of the protection layer is 40 cm.
- The minimum corresponding stone weight of the protection layer is 100 kg.
- The thickness of the protection layer $L \geq 3 \cdot D_{50}$ ($3 \cdot 40$ cm) $\Rightarrow L = 1.5$ m with the ratio of slope 1:1.5 spread out from the altitude +2.65 m to -9.7 m.
- The bed stone protection system is composed of two layers, the thickness of the below layer is 1 m thick, the stone weight is 60 - 80 kg.
- In order to ensure stable and safe conditions, the stone protection slope is lengthened more 5 m from the front edge of the berth.

6 CONCLUSIONS

In the current development trend, cargo ships and specialized vessels tend to increase capacity and more new features. In addition, the demand for self-propelled ships in the process of berthing and unberthing the port is also required higher. The impact of the ship propeller on the bed water in front of the berth and the slope underneath the berth should be adequately considered in the construction design to ensure the safe, technical - economic efficiency for the life time of the berth.

The article presents the scour impact of ship main propeller on the bed stone protection layer of the open piles berth. Besides, some scour protection methods for bed water in front of berth and slope underneath the open berth under impact of main ship propeller is also discussed here. The bed rock protection layer is proposed as its convenience in the conditions of Viet Nam where the open piles berths are applied most commonly. Therefore, the proposed method and the calculation procedure are expected to improve the quality of designing port and marine structure in Viet Nam.

REFERENCES

- [1] *TCVN 207:92, Design of Sea Port, Vietnamese Standards, 1992;*
- [2] *TCVN 9901: 2014, Irrigation constructions - Design of sea embankment, 2014;*
- [3] *TCVN 4253 : 2012, Foundation of hydraulic constructions - Design standards, 2012;*
- [4] *TCVN 8422:2010, Irrigation constructions - Design of filter layers of hydraulic construction, 2010;*
- [5] Carl A. Thoresen, *Port Designer's Handbook*, Institution of Civil Engineers, 3rd edition, 2014;
- [6] PIANC, *The World Association of Waterborne Transport Infrastructure*, Technical Report 2014;
- [7] EAU 2004, *Recommendations of the Committee for Waterfront Structures: Harbours and Waterways*, 8th Edition, 2004;
- [8] PIANC, *The World Association of Waterborne Transport Infrastructure*, Technical Report 1997;
- [9] J.G. de Gijt & M.L. Broeken, *Quay Walls*, CRC Press, 2nd edition, 2014.

SHIP MANOEUVRE ANALYSIS AND SIMULATION TO OBTAIN SCOURING RELATED PROPELLER VARIABLES

**LLULL, T.*, MUJAL-COLILLES, A. *, GIRONELLA, X. *, CASTELLS,
M. †, MARTÍNEZ DE OSÉS, X. †, MARTIN, A. †, SÁNCHEZ-ARCILLA,
A. ***

* Marine Engineering Laboratory, Department of Civil and Environmental Engineering (LIM/UPC-
BarcelonaTech)
Universitat Politècnica de Catalunya – BarcelonaTech
Carrer Jordi Girona, 1, 08034 Barcelona, Spain
e-mail: antoni.llull.marroig@upc.edu, web page: <http://lim.upc.edu>

† Barcelona School of Nautical Studies (FNB/UPC-BarcelonaTech)
Universitat Politècnica de Catalunya - BarcelonaTech
Pla de Palau, 18, 08003 Barcelona, Spain
e-mail: mcastells@upc.edu, web page: <http://www.fnb.upc.edu>

Keywords: AIS data, ship trajectory monitoring, ship simulator, scouring action, propeller generated erosion.

Abstract. The evolution of shipping industry in terms of bigger and more powerful ships, is causing several issues in existing ports and marinas designed, initially, to host smaller vessels with smaller propulsion systems and lower drafts, such as harbour basin erosion near quay walls, deposited zones in low frequented areas and reduction of operational areas. Previous studies concluded that main problems come from regular vessels such as ferries, which dock and undock frequently in the same quays performing the same manoeuvres. This contribution deals with a method to reproduce real ship manoeuvres in a full mission ship simulator obtained through Automatic Identification System (AIS) data analysis. A faithful reproduction permits to extract propeller and propulsion variables, which, in turn, allow the study of the scouring action using literature formulae. Results obtained show that AIS data can be used to obtain manoeuvring patterns, allowing the study of the scouring action for every particular case depending on vessel type, manoeuvre or met-ocean conditions.

1 INTRODUCTION

The evolution of shipping industry in terms of bigger and more powerful ships, is causing several issues in existing ports and marinas designed, initially, to host smaller vessels with smaller propulsion systems and lower drafts, such as harbour basin erosion near quay walls, deposited zones in low frequented areas and reduction of operational areas. The erosion of port

sediment in which quays and other structures are settled is leading to structural problems caused by scouring action and navigational problems due to sediment transport and relocation. Previous studies concluded that main problems come from regular vessels (excepting tugboats and pilot vessels) such as ferries, which dock and undock frequently in the same quays performing the same manoeuvres. Moreover, ferry ships require a particular quay to allow their ramping systems to be used during port operations, which is parallel to the propeller plane, so it is perpendicularly affected by main propellers generated thrust during docking and undocking manoeuvres.

This problem has been approached in engineering by several authors over the last decades, mainly through laboratory studies considering mostly one single propeller ([1]–[5]), with more recent research using twin propeller generated streams ([6]). They consider different combinations of the main propellers characteristics such as rotational velocity, pitch, blade projected area, etc., to obtain the size and location of the generated scour depending on the propeller behaviour. However, the real value of these variables, in particular rotational velocity and pitch, are mostly unknown by harbour authorities and researchers. The study of the manoeuvre, obtained through AIS data analysis ([7]–[9]), and its reproduction by means of a full mission bridge simulator can be used to obtain the evolution of parameters directly related with the scouring action.

This contribution deals with a method to reproduce real ship manoeuvres in a full mission ship simulator starting from AIS data analysis from a concrete study case. A faithful reproduction permits to extract variables such as rotational velocity, engine power and propeller pitch, which, in turn, allow the study of the scouring action using literature formulae. Once the engine and propeller behaviour variables are obtained and related to the geographical position of the ship during the maneuver, the points of maximum forcing can be located, giving the port authorities a clue about the most probably affected area so that they can arrange prevention and protection actions.

2 SCOURING VARIABLES

Equations proposed by the guidelines of PIANC [1] use as independent variables i) the efflux velocity: V_0 ; ii) ship propeller features: propeller diameter, D_p , power, P ; and iii) seabed and manoeuvre characteristics such as the sediment size, D_{50} , the clearance distance, c , and sediment density. The first variable introducing uncertainty is the efflux velocity. Many authors have tried to validate a coefficient, A , for the equation obtained using the momentum and mass conservation conditions:

$$V_0 = AnD_p\sqrt{C_T} \quad (1)$$

with n , the speed rotation in *rps*, and C_T the thrust coefficient of the propellers.

According to the axial momentum theory, $A = 1.59$, but Hamill and Johnston [10] propose $A = 1.03$, whereas Hashmi [11] increase it up to $A = 1.1$. Stewart in his PhD thesis developed a more complex equation to obtain the coefficient A through the characteristics of the propellers:

$$A = D_p^{-0.0686} p^{1.519} \beta^{-0.323} \quad (2)$$

where p is the pitch to diameter ratio and β is the blade expanded area ratio.

However, using the axial momentum theory as the basis, efflux velocity can be computed using other variables, when one of the previous variables is difficult to obtain –usually the thrust coefficient. Eq. (3) is proposed by the Spanish guidelines [12] for non-ducted propellers and also by the international guidelines published by PIANC [1]. The main differences are the percentage of maximum installed power, P_p , each of them recommends: $f_p = 0.4$ and 0.15 respectively; and the coefficient C_1 , for which they recommend 1.17 and 1.48 respectively

$$V_0 = C_1 \left(\frac{f_p P_p}{\rho_w D_p^2} \right)^{1/3} \quad (3)$$

All the previous equations have been proposed for single propellers after experimental campaigns in laboratories. Mujal-Colilles et al. [13], compared the laboratory experiments of twin propellers with the equations present in literature and concluded that both Eq. (1) and Eq. (3) overestimated by a factor of two the experimental results, yielding Eq. (1) closer results.

The second variable needed to estimate the seabed erosion is the velocity at the seabed. Blockland and Smedes [14] proposed the following expression using in-situ measurements

$$V_b = 2.8V_0 \frac{D_p}{X_w + \left(c + \frac{D_p}{2} \right)} \quad (4)$$

where X_w is the distance from the propellers to the vertical wall of the quay. Again, the uncertainty is introduced by the several definitions of the efflux velocity.

Finally, according to the conclusions found in Mujal-Colilles et al. [15], the maximum scouring depth in confined situations, ε_{max}^c , is located close to a vertical wall and can be computed using the equation proposed by Hamill et al. [5] for confined situations:

$$\begin{aligned} \varepsilon_{max}^c &= \varepsilon_{max}^u + \left[\varepsilon_{max}^u + \left(c + \frac{D_p}{2} \right) \right] \left[1.18 \left(\frac{X_w}{X_m^u} \right)^{-0.2} \right] \\ X_m^u &= cF_0^{0.94} \\ \varepsilon_{max}^u &= 45.04 \cdot 10^{-3} \Gamma^{-6.98} (\ln(t))^\Gamma \\ \Gamma &= 4.1135 \left(\frac{c}{D_{50}} \right)^{0.724} \left(\frac{D_p}{D_{50}} \right)^{-0.522} F_0^{-0.682} \end{aligned} \quad (5)$$

introducing more uncertainties since the densimetric Froude number, F_0 , includes at the same time the efflux velocity and the sediment diameter.

3 METHODOLOGY

AIS data is used as a reference to simulate the docking and undocking manoeuvre at a

particular harbour basin. Location of the harbour basin is kept confidential due to the requirements of the harbour authorities. Lat-Long data, Speed Over Ground (SOG) and Heading (HDG) are the main AIS variables guiding the simulation at the navigation simulator. A previous analysis of the docking and undocking maneuver during spring season indicates that the manoeuvre of the study vessel is similar every day. In particular, the study vessel is a Ro-Pax ferry with a daily docking frequency and a draft to depth ratio of up to 0.6.

A Transas NTPro 5000-v-5.35 simulator is used to reproduce the manoeuvre aiming to obtain the speed rotation, the pitch of the propellers during the manoeuvre and the power exerted by the propulsion system. Due to the lack of the particular ship, the simulation is performed using a similar vessel in terms of dimensions and propulsion systems. A comparison between them is shown in Table 1.

Table 1. Comparison between study and simulator vessel.

| Variable | Study Vessel | Simulator Vessel |
|-----------------------------------|---------------------|-------------------------|
| Vessel dimensions | | |
| Gross Tonnage (GT) | 25993 | 21104 |
| Maximum beam (m) | 27 | 25.5 |
| Depth (m) | 9.6 | 16.62 |
| Freeboard (m) | 3.2 | - |
| Maximum draft (m) | 6.4 | 6.5 |
| Maximum length (m) | 198.99 | 182.6 |
| Length between perpendiculars (m) | 177 | 166.29 |
| Propeller characteristics | | |
| Number of main engines | 2 | 2 |
| Indicated power (kW) | 12775 | 11520 |
| Number of propellers | 2 | 2 |
| Number of blades per propeller | 4 | 4 |
| Propeller diameter (m) | 5.1 | 5.0 |
| Propeller type | CPP | CPP |
| Delivered power (kW) | 11640 | 10714 |
| Propeller centroid depth (m) | 3.8 | 4 |
| Maximum engine R.P.M. | 500 | 510 |
| Maximum propeller R.P.M. | 137 | 130 |
| Rotational direction | Inward | Inward |

The main differences between the study and the simulator vessel observed in Table 1 are the depth, considered in the simulator as the sum of the maximum draught and the freeboard, but not an important variable in the equations presented so far, and the engine losses with a 2% difference between the study and the simulator vessel. Differences between the propeller centroid, the indicated power and the maximum engine *rpm* are not significant in terms of the results and the simulation of the maneuvers.

4 RESULTS

A comparison between AIS Lat-Long data and simulation results of the same variable is shown in **Figure 1**, where no big differences can be found either in arrival or departure maneuver. In fact, according to the Lat-Long position of the ship in the simulator, both maneuvers are reproduced almost equal to the real AIS data. **Figure 1** also confirms the few differences existing between one and another arrival/departure maneuver from different days. It is important to bear in mind that **Figure 1** plots the transmitting point of the vessel AIS data, which is located near by the bridge.

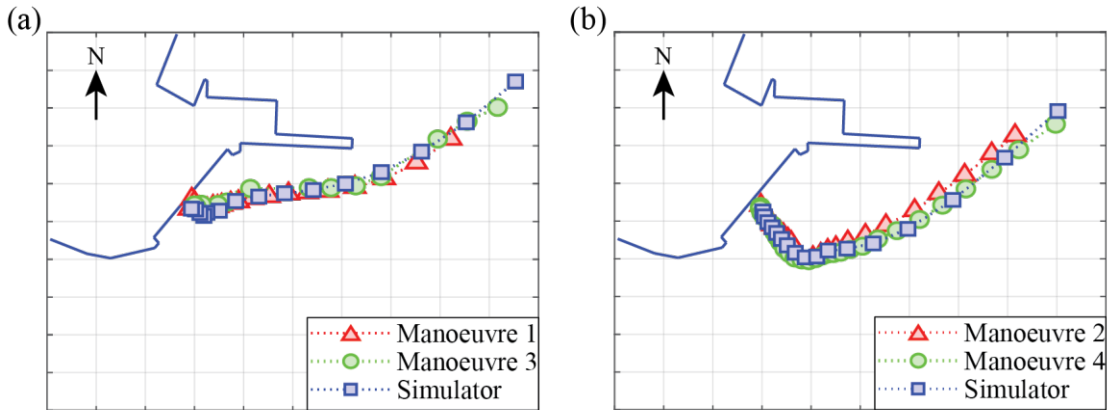

Figure 1. Comparison between AIS Lat-Long data and simulator Lat-Long results. (a) Arrival maneuver. (b) Departure maneuver.

The most harmful instants of each maneuver, according to the conclusions of Llull et al. [16], are plotted in **Figure 2**. During the arrival maneuver, when the ship is already parallel to the dock and the captain starts the stopping orders, the wash generated by the propellers is directed towards the wall being, therefore, a harmful potential action. This is marked using a circle with number one in **Figure 2a**. Likewise, the departure maneuver, **Figure 2b**, the wash is directed towards the Ro-Ro dock, at the beginning of the maneuver, number 2 in **Figure 2b**, and when the vessel is turning to exit the harbor basin, number 3 in **Figure 2b**.

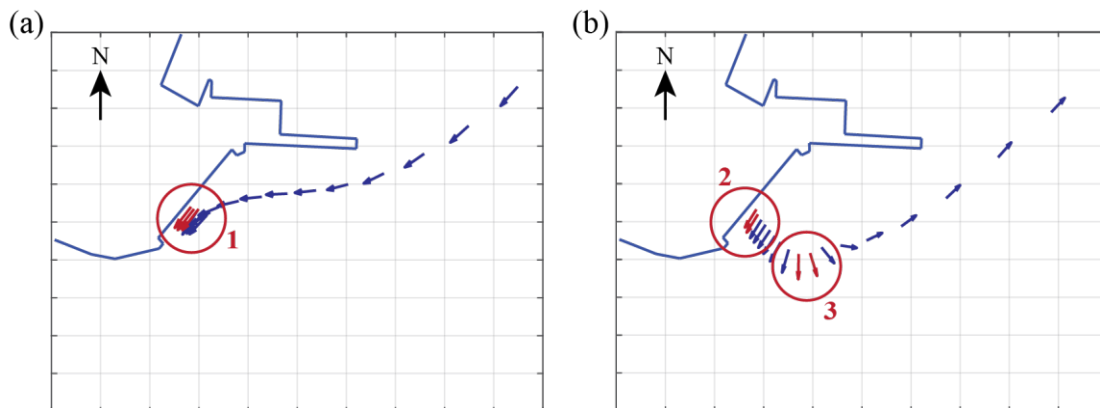

Figure 2. Vessel's heading arrows and details of the instants with maximum scouring potential from the stern propellers. (a) Arrival. (b) Departure.

The engine power, pitch ratio and speed revolution used in the particular moments described previously can be observed in the results obtained from the simulator in **Figure 3**. At the arrival maneuver, **Figure 3a**, during the last minutes of the maneuver, starboard engine is working astern using high engine power in order to stop the vessel. Although it is working astern and the flux is not directed towards the docking Ro-Ro wall, the high values of engine power and speed rotation, may create a scouring hole underneath the propellers. At the same time, the port propeller is working ahead with the flux impacting to the wall increasing the scouring action according to [5]. During the departure maneuver, **Figure 3b**, both at the beginning of the maneuver, number 2 in **Figure 3b** when the propellers are 28 m far from the docking wall, and during the turning action, number 3 in **Figure 3b** when the propellers are 155 m away from the docking wall, one of the propellers is working astern using higher engine power and speed rotation, while the other is working ahead with also relatively high values of engine power. The scouring potential of the latter but, is enhanced by the quay wall, which the propeller generated stream is directed to.

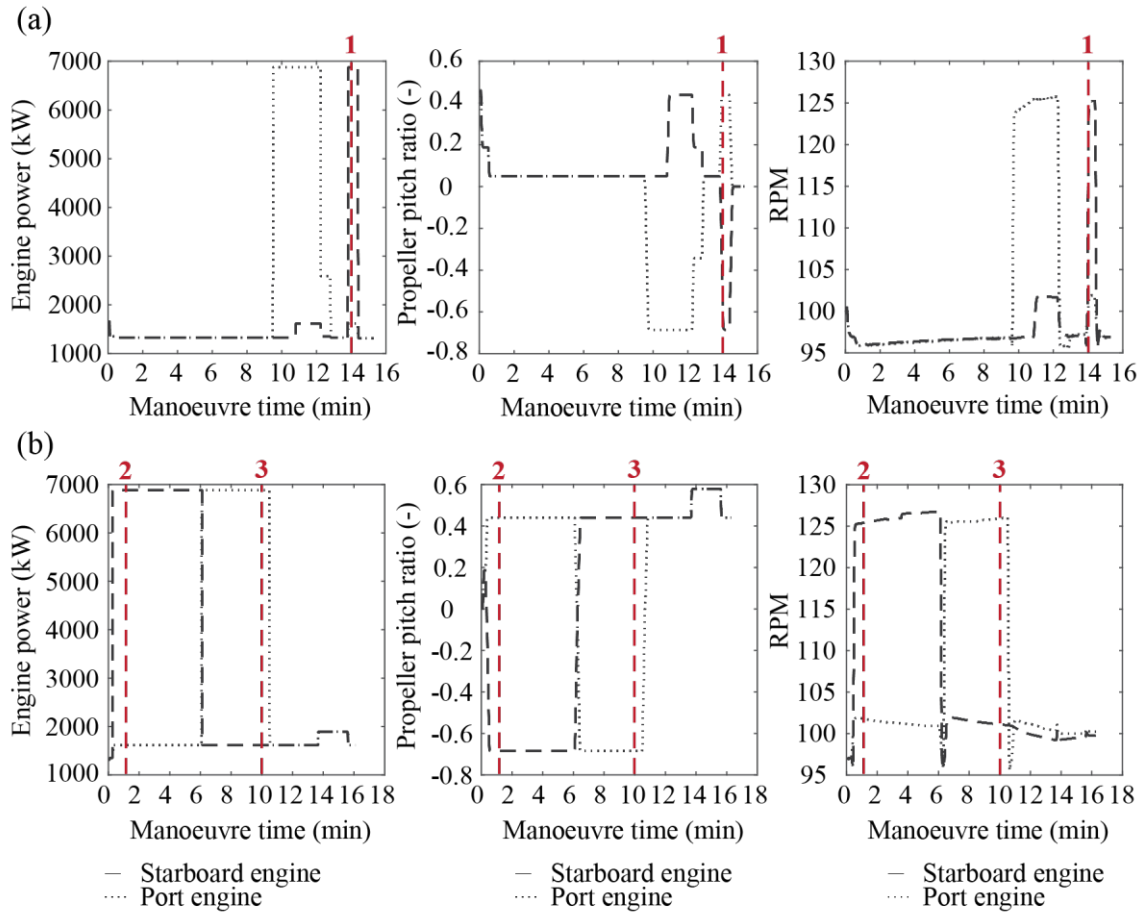

Figure 3. Results obtained from the navigation simulator. Red-dashed lines indicate the most potential harmful actions shown in Figure 2. (a) Arrival. (b) Departure.

If the values of the variables obtained from **Figure 3** using the navigation simulator are introduced to obtain the efflux velocity, Eq. (1) and the bed velocity, Eq. (4), final values are

more scarce for the efflux velocity, as seen in Figure 4, although Eq. (4) already introduces the uncertainties in efflux velocity values. Maximum efflux velocity results are obtained during the first instants of the departure maneuver. Consequently, maximum values in bed velocity are also found at the same moment since the bed velocity is proportional to the efflux velocity. Therefore, apparently, the maximum scouring depth shall be produced at the first instants of the departure maneuver by the port propeller, which is working ahead.

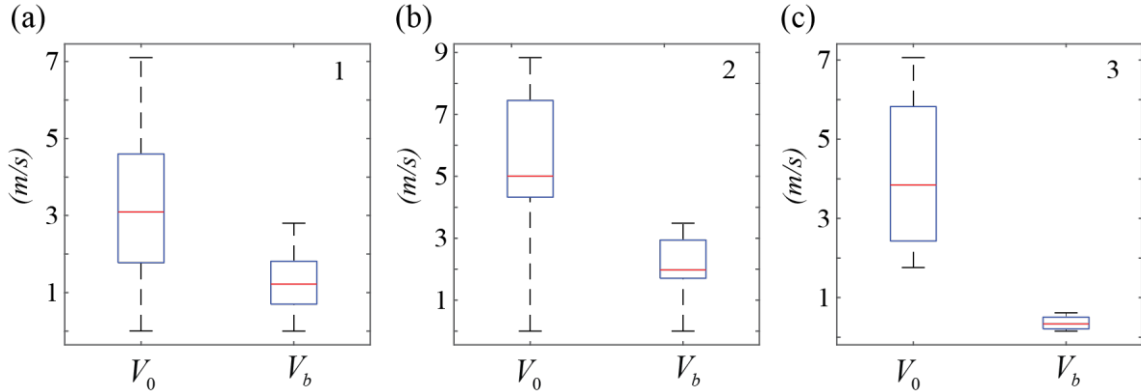

Figure 4. Efflux velocity and bed velocity results for the maximum potentially harmful instants according to Figure 2. (a) Arrival -1. (b) Departure -2. (c) Departure -3.

Scouring results obtained using Eq. (5), plotted in Figure 5 use only the values of speed rotation and engine power of the propellers working with the flux towards the wall, this is positive pitch values. According to Hamill et al. [5], the presence of a wall can increase the maximum erosion depth up to a factor of 1.5. Results are within the expected order of magnitude using real values of the maneuver. Figure 5 shows that the maximum scouring depth is found at the beginning of the departure maneuver. The last times of the arrival maneuver, red line in Figure 5a are also more harmful than the moment when the ship is turning during the departure, Figure 5b, due to the closer position of the stern with respect to the docking wall.

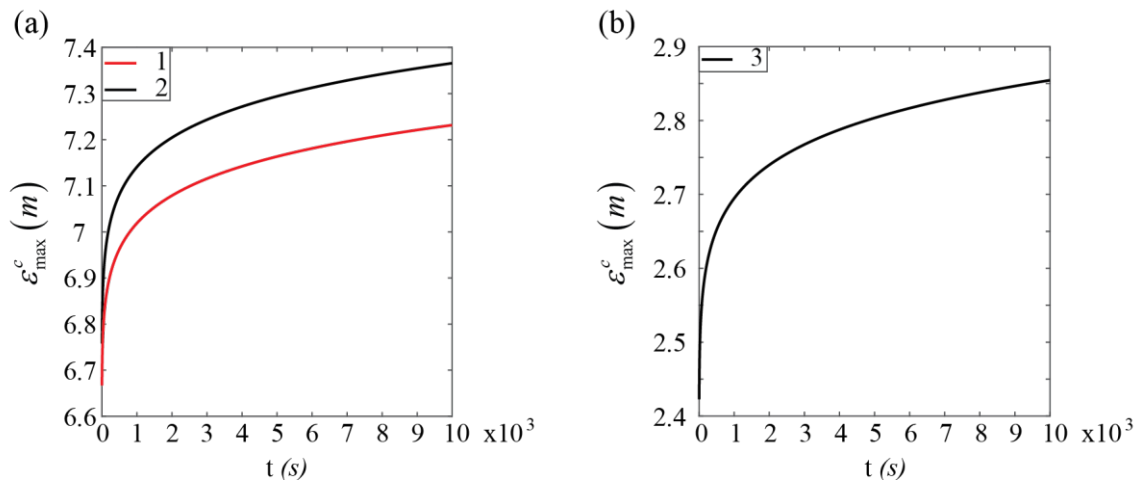

Figure 5. Maximum erosion depth for confined situations at the instants detailed in Figure 2. (a) Arrival -1 and Departure -2. (b) Departure -3.

5 CONCLUSIONS

In the present paper, the reproduction of the arrival and departure maneuvers using a navigation simulator is introduced as a methodology to estimate the maximum scouring depth. The simulation, performed after analyzing the AIS data of each maneuver, permitted to obtain the variables needed in the formulas used to predict the maximum scouring depth. After introducing the value of these variables, the results help to conclude that:

- The use of the simulator is needed to predict maximum scouring depth. Otherwise, variables value far from reality in terms of speed rotation, pitch and engine power can yield unrealistic results.
- AIS data analysis turns to be very useful to find out the manoeuvre patterns of a particular ship on a particular basin to later mimic the manoeuvre.
- Departure maneuver is more dangerous since it produces larger scouring holes and, therefore, can damage the docking structures. Moreover, the time interval within which the propeller generated wash is impacting against the wall is larger during this manoeuvre.

REFERENCES

- [1] PIANC, *Guidelines for protecting berthing structures from scour caused by ships. Report n° 180*. The World Association for Waterborne Transportation Infrastructure, 2015.
- [2] D. P. J. Stewart, "Characteristics of a ship's screw wash and the influence of quay wall proximity," *Dr. Diss. Queen's Univ. Belfast*, 1992.
- [3] D. Ryan and G. a. Hamill, "Determining Propeller Erosion at the Stern of a Berthing Ship," *J. Waterw. Port, Coastal, Ocean Eng.*, no. August, p. 104, 2012.
- [4] G. Hamill, "The scouring action of the propeller jet produced by a slowly manoeuvring ship," *Bull. Perm. Int. Assoc. Navig. Congr.*, vol. 62, 1988.
- [5] G. Hamill, H. T. Johnston, and D. Stewart, "Propeller Wash Scour Near Quay Walls," *J. Waterw. Port, Coast. Ocean Eng.*, vol. 125, no. 4, pp. 170–175, 1999.
- [6] A. Mujal-Colilles, X. Gironella, A. Jaquet, R. Gomez-Gesteira, and A. Sanchez-Arcilla, "Study of the Efflux Velocity Induced By Two Propellers," in *SCACR, Conference on Applied Coastal Research*, 2015.
- [7] M. Castells, F. X. M. De Osés, A. Martín, A. Mujal and X. Gironella, "Tools for evaluation quay toe scouring induced by vessel propellers in harbour basins during the docking and undocking manoeuvring," *Mar. Navig. Saf. Sea Transp.* 61-66., 2017.
- [8] K. Gunnar Aarsæther and T. Moan, "Estimating navigation patterns from AIS," *J. Navig.*, vol. 62, no. 4, pp. 587–607, 2009.
- [9] K. G. Aarsæther and T. Moan, "Computer vision and ship traffic analysis: Inferring maneuver patterns from the automatic identification system," *Mar. Navig. Saf. Sea Transp.*, vol. 4, no. 3, pp. 303–308, 2009.
- [10] G. Hamill and H. T. Johnston, "The decay of maximum velocity within the initial stages of a propeller wash," *J. Hydraul. Res.*, vol. 31, no. 5, 1993.
- [11] H. N. Hashmi, "Erosion of a granular bed at a quay wall by a ship's screw wash.," *PhD thesis, Queen's Univ. Belfast, North. Ireland;*, 1993.
- [12] Puertos del Estado, "Obras de Atraque y Amarre: Criterios generales y Factores del Proyecto (R.O.M. 2.0-11)," *R.O.M. 2.0-11*, 2012.
- [13] A. Mujal-Colilles, X. Gironella, A. J. C. Crespo, and A. Sanchez-Arcilla, "Study of the bed velocity induced by twin propellers," *J. Waterw. Port, Coast. Ocean Eng.*, vol. 143, no. 5, 2017.
- [14] R. H. Blokland, T., & Smedes, "In situ tests of current velocities and stone movements caused by a propeller jet against a vertical quay wall.," *Proc. 11th Int. Harb. Congr. Antwerp, Belgium.*, 1996.
- [15] A. Mujal-Colilles, X. Gironella, A. Sanchez-Arcilla, C. Puig Polo, and M. Garcia-Leon, "Erosion caused

- by propeller jets in a low energy harbour basin,” *J. Hydraul. Res.*, vol. 55, no. 1, 2017.
- [16] T. Llull *et al.*, “Hybrid tool to prevent ship propeller erosion,” in *Proceedings of the ASME 2018 37th International Conference on Ocean, Offshore and Arctic Engineering (OMAE2018)*, 2018.

BARRIERS TO WOMEN'S LEADERSHIP IN MARITIME AND THE WAYS TO OVERCOME THEM

DR. PINAR OZDEMIR^{*} ASSOC. PROF. DR. TANER ALBAYRAK[†]

^{*} English Prep Department, Piri Reis University, Istanbul, Turkey
pozdemir@pirireis.edu.tr

[†] Faculty of Economics and Administrative Sciences
Department of Maritime Business Management
Piri Reis University, Istanbul, Turkey
talbayrak@pirireis.edu.tr

Key words: Maritime, Networking, Virtual Mentoring, Authentic Leadership

Abstract. Maritime is a male-dominated sector and as in all male-dominated sectors, women working in maritime jobs face some problems deriving from not only the special nature of the jobs but also the hardships they face because of the bias against them in this sector. There are very few women leaders in the maritime due to these reasons and this fact deprives the sector, which is in need of a lot of qualified staff, of the positive contributions women can make. That's why some precautions should be taken to eliminate those barriers in order to enhance women's participation and leadership in the sector and give women the place they have already deserved. In this paper, data about problems related to women's leadership are gathered by a survey and some suggestions to overcome these are discussed in a workshop by women in maritime. At the end of the study, it was decided that two methods could work better than others: Providing networking and mentoring opportunities to the women in maritime and authentic leadership of women in maritime. The ultimate goal of the study is to create part of a strategy to be applied in maritime to help women reveal the leadership traits they already have, excel in their jobs and reach top positions. Following studies can be carried out to complete the strategy and to take it further.

1 INTRODUCTION

Leadership is the art of motivating a group of people to act towards achieving a common goal. The leader is the inspiration and director of the action. He or she is the person in the group that

possesses the combination of personality and leadership skills that make others want to follow his or her direction [1]. Theoretically, men and women have the same rights, may have almost the same education and more or less the same traits. That means they have the same chance to be leaders, but this is not the case in practice.

In today's large organization, as women climb up the corporate ladder they vanish. While the statistics vary slightly around the world, this is an extremely consistent pattern. At the lowest levels, more than half of the employees in organizations are female. As you move to each successively higher level in the organization, the number of women steadily shrinks. At the CEO level, worldwide, there are only 3% to 4% who are women [2]. According to a report by the European Commission (2012), in the European Union, as of the beginning of 2012, women constituted only 13.7% of board seats [3]. The ratio changes and decreases dramatically when male-dominated sectors are in question. The shipping sector of maritime business is one of the male-dominated sectors. Women make up only an estimated 2% of the world's seafaring workforce. Their low number, which is about 23,000 worldwide, means that women can face a number of hardships and may even be subject to discrimination and harassment [4]. Maritime requires both physically and mentally tough people, requires leadership skills and swift decision making qualities and is less tolerant for gender differences [5].

Increasing the number of women in maritime jobs will raise awareness for the presence of women on board the ships, create a woman friendly atmosphere which requires the men to heed their behaviour and language, encourage appropriate behaviour amongst personnel and foster camaraderie. In addition, more women aboard and more women in leadership positions in maritime sector means varied and different viewpoints about everything taking place on board a ship, and an increase in the chance to respond more effectively to the requirements of the ever changing maritime industry. Because of all these reasons, it is a must to increase not only the number of women in maritime but also the effectiveness of their job performance. It is clear that some measures should be taken to realize these. To decide what measures they may be, the reasons causing these problems should be determined correctly first.

2 METHOD

The data used in this study was collected through a survey and a workshop. In the first part of the study, the responses given to the questions in the survey have been analysed. The questions in the survey are some of the questions originally used in the survey in **MENTORESS** (Maritime Education Network to Orient and Retain Women for Efficient Seagoing Services) **Project**, a project funded by the EU, aiming to furnish women in maritime with leadership qualities. There are 50 questions in the survey prepared for the project, 24 of which are related to this research and are taken into consideration while doing the study. The survey is given in the website of MENTORESS Project and all the parties concerned are called upon to respond to the survey. By the time this study was made, 233 people, 73 of whom are women and 160 of whom are men had responded to the survey. In the second part of the study, a workshop was held with the attendance both of cadets from maritime schools and professionals from maritime sector. The exchange of ideas during the workshop provided an insight into ways to help women

cope with bias and problems in reaching leadership positions. Drawing upon the information obtained from the survey and the workshop, leadership styles and assistance methods were taken into account with an eye to find ways to increase effectiveness and the number of women in maritime.

3 STUDY

Upon evaluation of the data, the causes of problems encountered by women in maritime have been identified and it is seen that these problems can be grouped under three headings, which are: Problems of Disapproval by Men, Problems Deriving from Lack of Guidance and Problems Related with Acquiring Leadership Skills.

3.1 Problems of disapproval by men

Figure 1 shows the percentage of responses related to the questions about the acceptance problem for women by men, which can be seen at Table 1.

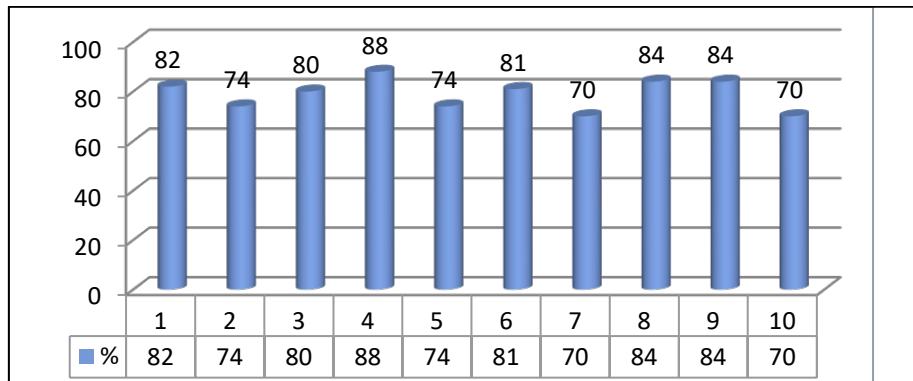

Figure 1. Percentage of Responses Given by Women to the Statements in This Part

Table 1. Statements Used in This Part and Percentage Responses by Women and Men

| NO | STATEMENT | I Agree (%) | |
|----|-----------------------------------------------------------------------------------------------------------|--------------|-----|
| | | WOMEN | MEN |
| 1 | The male counterparts perceive the female crewmembers as threat in competition | 82 | 33 |
| 2 | If the female crewmembers behave like a man they will be accepted easily | 74 | 64 |
| 3 | Men prefer working with other men because they think women aren't strong enough | 80 | 69 |
| 4 | Men think the presence of women on board will limit their behaviours. | 88 | 72 |
| 5 | Some officers who trust female crewmembers, still advise them to work onshore | 74 | 70 |
| 6 | When a woman succeeds in her job, male staff will be jealous of her | 81 | 44 |
| 7 | If a female crewmember makes a mistake, the feedback and reactions are exaggerated | 70 | 43 |
| 8 | It is hard for women to find appointments on board ships because the ship owners are biased against women | 84 | 69 |
| 9 | Males believe that the presence of females on board a ship will cause trouble | 84 | 60 |
| 10 | Women working at sea have less chance to be promoted to higher positions than men | 70 | 49 |

The responses show that maritime is still seen as a men's job as it has always been seen in the past. There is a strong prejudice against women in maritime domain, especially on board ships. Those biased against women include ship owners too, and this makes the situation even worse by decreasing their chances of finding a job on board. The data shows that being able to find a job on board a ship is not the end of their problems, but just the beginning.

Once they are able to find a job on board a ship, they face another problem related to the perception of women on board by men, because men on board think that the presence of women there will limit their behaviour, prevent them from behaving freely, and hinder their promotion to higher positions. Because of this, they are usually seen as a threat in competition for better positions. On the other hand, "The feedback and reaction for the mistakes by women are not proportionate to the cause," can be deduced that there is even mobbing. Furthermore, it is widely accepted that women are advised to work ashore units although it is known that they are capable of doing every job except for those requiring physical power as efficiently as men. Men believe women bring trouble along on board and they don't prefer working with them. These kinds of behaviour are also different forms of mobbing and they are discouraging for women, who already suffer from the problems of not only working in a male dominated job but also working in a place far from their families and friends for a long time, and who are not able to get psychological help easily from them or experts because being far from the land. The analysis of data also indicates that women acknowledge the problems they face aboard ship and they need help in coping with hardships such as prejudice, mobbing and fighting against jealousy.

3.2 Guidance requirement

Figure 2 shows the percentage of responses given by women to the questions related to guidance requirement which can be seen at Table 2.

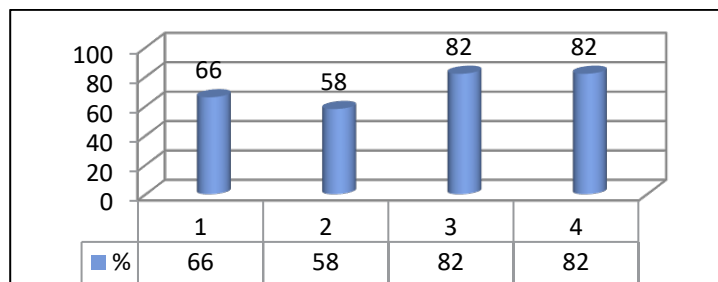

Figure 2. Percentage of Responses Given by Women to the Statements in This Part

Table 2. Statements Used in This Part and Percentage Responses by Women and Men

| NO | STATEMENT | I Agree (%) | |
|----|----------------------------------------------------------------------------------------------------------------------|-------------|-----|
| | | WOMEN | MEN |
| 1 | Working on board a ship is mentally more tiring for the female crew members | 66 | 74 |
| 2 | The female crewmembers feel lonely and helpless on board the ship | 58 | 46 |
| 3 | Female professionals could perform better if they are given prior education on working in a male dominated workplace | 82 | 72 |
| 4 | I would prefer at least another women to work with me on a ship | 82 | 79 |

A high percentage of women agreeing with the statements above show that women in the maritime sector, especially those working on board, are in need of guidance and friendship. Maritime jobs are hard and demanding even for men, who constitute the majority of the personnel on board. There is usually a strong communication among them, so if they have a problem they will share it with each other or if they need help they can easily ask for it from their co-workers. On the other hand, for a woman who already feels isolated because of strong prejudice, it is hard to ask for help or to expect any kind of support from men who are mostly against her presence on board. Therefore, it seems vital to reach women to provide the support they need in maritime via easily available means for them, even when they are at sea.

3.3 Problems related to acquiring leadership skills

Figure 3 shows the percentage of responses given by women to the statements related to acquiring leadership skills. These statements can be seen at Table 3.

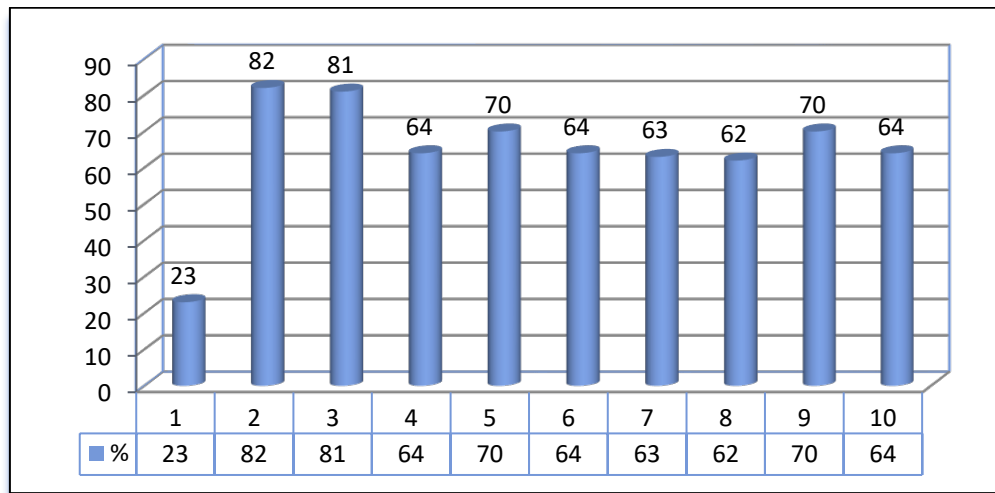

Figure 3. Percentage of Responses Given by Women to the Statements in This Part

Table 3. Statements Used in This Part and Percentage Responses by Women and Men

| NO | STATEMENT | I Agree (%) | |
|----|---------------------------------------------------------------------------------------------------------------|-------------|-----|
| | | WOMEN | MEN |
| 1 | Male staff accepts women as equal on various tasks on board ships. | 33 | 54 |
| 2 | Men are preferred even if the female crewmembers have the same qualifications. | 82 | 66 |
| 3 | Women in maritime are likely to experience some form of sexual harassment. | 81 | 66 |
| 4 | The successful achievements of a female are usually ignored. | 64 | 39 |
| 5 | When a female crewmember makes a mistake, the feedback and reaction are exaggerated. | 70 | 43 |
| 6 | Starting from the entry stages, the women are told and advised about the negative aspects of maritime career. | 64 | 67 |
| 7 | The decisions and ideas of female staff are continuously criticized and questioned. | 63 | 39 |

| | | | |
|----|---------------------------------------------------------------------------------------------------------------------|----|----|
| 8 | I feel the women personnel have to work harder to be accepted as equal by the male counterparts and the supervisors | 62 | 46 |
| 9 | Women working at sea have less chance to be promoted to higher positions than men. | 70 | 49 |
| 10 | I think the behaviour of male staff discourages the female staff to perform better. | 64 | 49 |

As the responses show, women feel left out on board ship. They think almost all the attitudes of male personnel have negative implication for them. Although men don't confess to it, it is easy to understand this from the way they act, speak, think and judge. Most women in maritime feel they are not welcome on board and men are ready to find fault with their work. Men's discontent is reflected in the way they behave. They tend to exaggerate the mistakes women make while ignoring their achievements. This causes women to work harder to prove themselves and to get the positions they deserve. Men are still preferred in cases where they have the same qualifications for a job, so women must be much better to be accepted as equal. Unfortunately these kinds of discouraging behaviours have a tremendous effect on women. It causes them to lose self-confidence and enthusiasm towards their job, which means it will be hard for them to struggle to continue working on board if they don't have any support. This may even result in women giving up the struggle and leaving their job, at least those on board. In the light of the data obtained from the survey, it is concluded that females in the sector need to be stronger and equip themselves with some qualifications to cope with the problems they face, to be treated as equal and to get what they deserve. Another equally important point that can be concluded from the survey is that males in maritime sector should receive some kind of "training" to understand and appreciate the place of women in maritime and to get rid of the bias against them. Considering the discrepancy between the responses given to the same statements by women and men, it can be said that men, consciously or unconsciously, may cause women to be alienated from their jobs and this may result in the loss of important positive contributions women may make to maritime.

3.4 Suggested ways to overcome the barriers

It is clear that some measures should be taken, and a novel strategy should be adapted to overcome these hardships and to enhance women's leadership qualities, which will hopefully increase the number of women struggling for leadership positions in maritime. But, definitely, there is no magic bullet to solve the leadership gap of women in general and women in maritime in particular [4, 6]. Fortunately this problem does not require magic. There are a number of common sense steps that can be taken as individuals, employers and policy makers to create significant change. Drawing from the survey we administered and taking the suggestions made by the workshop attendees into consideration, we think that two methods can work for women in maritime. These are providing female cadets and staff with effective networks and mentors, and emphasizing authentic leadership qualities in them.

Networking means interacting with others to exchange information and developing professional or social contacts. It is an important personal and professional activity for women in maritime since they can meet new people, make new friends, find a new job, develop their current career, explore new career options, or simply broaden their professional horizons. They can also meet

other women from the sector and exchange their experiences. These are rare opportunities for women in maritime because of their working conditions and small number in the sector. These kinds of events also foster solidarity among them and help them find mentors who can provide guidance they may need in particular occasions. Apart from this, women in maritime need to have a good network due to their small percentage in maritime workforce, where there is a lot of bias against them and they are likely to be left out. *Mentoring* is a system of semi-structured guidance whereby one person shares their knowledge, skills and experience to assist others to progress in their own lives and careers. It's important for the mentors to be readily accessible and prepared to offer help as the need arises [7]; however, it is not always possible in maritime. Ships are the places where women have the most problems, where they feel lonely the most, where they are subject to mobbing and harassment, even sexual harassment. To make things worse, they are also the places where it is hardest to find anyone to share their problems with. Thus the best way to provide women in maritime with help seems to be virtual mentoring which is providing mentoring by the help of technological devices such as telephone, email or other means of communication. It is quite a beneficial form of mentoring when mentor and mentee are away from each other and are not likely to meet soon, as is often the case in maritime. By virtual mentoring, perhaps they won't be able to see their mentors face to face, but they will have the advantage of reaching them anytime or anywhere they like.

Authentic Leadership is a management style in which the authority figure of a group or organization deals with and communicates with his or her followers in a truthful and direct way. [8] They don't hide their mistakes or weaknesses out of fear of looking weak. They don't try to hide their limitations, either. [9] This does not mean authentic leaders are "soft." In fact, communicating in a direct manner is critical to successful outcomes, but it's done with empathy. The latest studies in the field of leadership describe authentic leadership as an empowering style for women. [10] Another study emphasizes that leading with greater authenticity instead of adapting to other people's expectations may unlock more leadership potential in women and accelerate their impact within their organization. [11] By expressing more of their true self, women embrace a wider range of leadership characteristics needed to run an organization. It is also said that women leaders are more empathetic and flexible, as well as stronger in interpersonal skills than their male counterparts [12]. They are able to bring others around to their point of view or alter their own point of view. They can do this because they genuinely understand and care about where others are coming from. [12] That is an essential trait with respect to the issue of diversity management, which is of vital importance in maritime. A ship is a place where people from all walks of life come together to work and, once they are at sea, they are alone with all kinds of problems that can be caused by coming from different backgrounds and cultures and having different expectations. An authentic leader has the skills to lead them efficiently.

4 CONCLUSION

Like all working women, women in maritime have some problems. These problems are doubled because of working in a male dominated work place and tripled because of being at sea. To cope with them, women need to take up some assisting methods such as networking and virtual mentoring and they need to behave like their true selves, that is, authentically. Access to influential networks is critical to moving up the leadership hierarchy. Some studies have found that the social capital gained from networking with influential leaders is even more important for advancement than job performance. Mentoring and virtual mentoring may enable women in maritime to counsel and get help from experienced people. These will enable them to interact with people from the sector and make their voice heard, and will also help men to have a chance to get to know the women in the sector so that they may appreciate their competence in maritime. Women have some traits like patience, strong interpersonal skills, empathy or flexibility. They should behave like women, not like men, and make use of these traits to the full extent in their interaction with people. Being like themselves and acting naturally will make them authentic and carry them to leadership positions. Authentic leadership is accepted as the best leadership style for women. It shouldn't be forgotten that while women realize themselves and take out the potential they have for the good of the maritime, maritime will be the party that will benefit from the situation the most, because women are the other half of society and without them, like everything else, maritime will also be incomplete.

5 REFERENCES

- [1] What is Leadership? [viewed 2018-03-07]. The Balance Small Business 07-17-2017 Available from the Internet: <https://www.thebalance.com/leadership-definition-2948275>
- [2] SHERWIN, B. 2014, Why Women Are More Effective Leaders Than Men? Business Insider 2014-1 [viewed 2018-03-10]. Available from the Internet: <http://www.businessinsider.com/study-women-are-better-leaders-2014-1>
- [3] PATEL, G. and S. BUITING. 2013, Gender Differences in Leadership Styles and the Impact within Corporate Boards, Commonwealth Secretariat,, 2013, 8 [viewed 2018-02-20]. Available from the Internet: <http://www.cpahq.org/cpahq/cpadocs/Genderdiffe.pdf>
- [4] Women Seafarers. *Inside the Issues* [viewed 2017-12-11]. Available from the Internet: <http://www.itfseafarers.org/ITI-women-seafarers.cfm>
- [5] OZDEMIR, P. and ALBAYRAK, T. Women Maritime Global Leadership How To Cope With Second Generation Gender Bias In Male-Dominated Occupations. In KITADA, Momoko, Lisa FROHOLD, and Erin WILLIAMS, eds. *Maritime Women: Global Leadership*. Springer, Verlag, Berlin, Heidelberg: Springer, 2015, pp. ISBN10 3662516071. ISSUED also as an eBook: ISBN 9783662453858
- [6] AFKHAMI, M., A. EISENBERG and H. VAZIRI Leading to Choices, A Leadership Training Handbook for Women. Bethesda, MD, USA. 2001 ISBN 0-9710922-0-6 [viewed

2018-05-10]. Available from the Internet:
<http://www.learningpartnership.org/docs/engltcmanual.pdf>

[7] Personal and Professional Development, What is Mentoring? [viewed 2018-05-10]. Available from the Internet: <https://www.ppd.admin.cam.ac.uk/professional-development/mentoring-university-cambridge/what-mentoring>

[8] The TechTarget Network, Authentic Leadership [viewed 2018-05-10]. Available from the Internet: <https://searchcio.techtarget.com/definition/authentic-leadership>

[9] KRUSE, K. 2013 What is Authentic Leadership? Forbes Journal [online] 2013 [viewed 2018-05-10]. Available from the Internet: <https://www.forbes.com/sites/kevinkruse/2013/05/12/what-is-authentic-leadership/#38727c6edef7>

[10] WALLICK, J. 2017, Authentic Leadership and What It means for Women, [viewed 2018-05-06]. Available from the Internet: <https://blog.westmonroepartners.com/authentic-leadership-means-women/>

[11] "RAUKER, D.& J. FELDMAN 2015 How Being Authentic Accelerates Leadership in Woman?" [viewed 2018-05-10]. Available from the Internet: <https://www.kornferry.com/institute/how-being-authentic-accelerates-leadership-in-women>

[12] The Qualities That Distinguish Women Leaders, [viewed 2018-05-10]. Available from the Internet: <http://www.calipermedia.calipercorp.com/whitepapers/us/Qualities-in-Women-Leaders.pdf>

HOW CAN WOMEN BE ENCOURAGED TO WORK IN MARITIME PROFESSIONS? - POSSIBILITIES FOR FLEXIBLE POST-GRADUATE STUDIES

NINNA ROOS

Faculty of Logistics and Maritime Management
Satakunta University of Applied Sciences
Suojantie 2, 26101 Rauma, Finland
e-mail: ninna.roos@samk.fi, <http://www.samk.fi>

Keywords: Women, Maritime Industry, Education & Training

Abstract. Maritime industry has traditionally been strongly dominated by men. Accordingly International Transport Worker's Federation world's maritime workforce still consist only 2% of women. There is need to improve these statistics and encourage women to build maritime career alongside with men, both at sea and on shipping related professions. Many prejudices and a lack of awareness about working in the field of shipping can affect women's willingness to seek into work places maritime sector. There can be many limiting issues for women, for instance many maritime related jobs ashore require experience from sea. [1] Not all possible professions available in maritime industry may be obvious for a young female who is making her career plans. A function of the socio-economic climate and social culture within different state have an influence on the seafarer manpower requirements. This can lead to diverse requirements for access into different shore-based sectors and seafarer have difficult to enter these positions due to the qualification level required. [2]

Agenda of several international organisations, governmental agencies and private organisations have been to promote the progress of women in maritime sector during the several decades. To attract women in the industry, also schools and educational institutions should have policies to help women understand and know about maritime professions. There is need for improvement of career awareness and preparedness. Planning of the future studies and profession start in early stage and young people need to have enough information and knowledge enough about different possibilities developing their careers before high school or college level, so that they can choose and concentrate on wanted courses in good time. For example, in Finland some high schools are offering advanced maritime courses in their curriculums.

This paper presents a survey conducted about women's role in maritime professions and career possibilities, using both experiences of students of Master programme in Maritime

Management in Satakunta University of Applied Sciences and interviews of graduated bachelor and master alumni's from the same University. This paper describes the current situation about the women's interest to seek their way to the maritime industry as well as presents possibilities how women can be encouraged to plan their career path first at sea on vessels and later, how can they make good use their valuable work experience at sea in shore-based organizations.

In this study the reasons for alumini's seeking into maritime profession are mostly explained by family's sea going careers and traditions. Also, a general interest towards maritime profession affects on willingness to seek the profession of the seafaring. Results of the survey relieved that the reasons for further studies for women interviewed were inclination to self-development and improving their career possibilities in labour market.

This article introduces the post-graduate studies that take into account student's sea going experience and can be accomplished at the same time when working and can support the progress of personal career.

This Master programme has been especially tailored to meet women's demand for a work in a land-based organization. Approximately 10 per cent of the graduates are women which is a lot more than women in general in maritime profession. The statistic survey reveals which has been conducted that the motivation among women students in master programme is higher and percentage of graduating students is especially high. Flexibility of the study programme has especially benefited women's participation and fast graduation. Reasons for this will be reported in the article and more closely surveyed in the interviews.

1 INTRODUCTION

Maritime industry has traditionally been strongly dominated by men. World's maritime workforce consists still only 2 % of female accordingly International Transport Worker's Federation statistics. In the global maritime cluster number of women increase slowly especially in cruise ships and also shore-side. One limiting issue for women participating in the maritime related jobs available ashore is that many of those places require experience from sea. [1]

To promote the progress of women in maritime sector has been on the agenda of several international organisations, such as WISTA (Women's International Shipping and Trading Association) among other, governmental agencies and private organisations during the several decades. Especially furtherance of gender equality has been an objective of the United Nations (UN) and its specialized agencies. [3] Development of the first programme to foster the advancement of women in the maritime industry was made by the International Maritime Organization (IMO) in 1988. The programme was called "Strategy on the Integration of Women in the Maritime Sector" (IWMS) and its main goals was to "*encourage IMO Member States to open the doors of their maritime institutes to enable women to train alongside men and so acquire the high-level of competence that the maritime industry demands*". [4] In other

words, the idea of IWMS programme was to increase the presence of female workforce in the developing countries through education, training and transmission of knowledge. [3]

One of IMO's priorities has also been harmonization of regional support networks for women in the maritime sector all over the world. As an outcome of this, there is nowadays seven regional associations for women in several continents. These regional networking platforms have provided possibilities for discussions about gender issues. [4] The need for the development of a new strategies to strengthen the role of women in the maritime sector has been realised and the sharing of the experiences of succeeded female role models have been important.

2 GENDER ISSUES AND MARITIME CAREER

The women's right to receive education and equal possibilities to work are still not obvious everywhere in the world. There are many barriers which may have an influence for female seeking into maritime related jobs. Some of those reasons are related to cultural and social issues and also to family and practical matters. How to arrange and balance family life and work at sea are often the big issues and have an influence on female career choices. Women may have to wrestle with masculine norms and values and therefore women's agency in male dominated occupations is continuously confronted. [5]

Possible career paths in maritime sector may differ between countries due to education systems and young women can have difficult to have information about all available career options. The study concerning career paths in the maritime industries in Europe made by European Community Shipowners' Association (ECSA) and the European Transport Worker's Federation (ETF) in 2005 pointed that there is a range of obstacles for career development, like a lack of information about jobs opportunities, how to arrange funding for further studies and the argument that shore jobs may often require re-location. A function of the socio-economic climate and social culture within different state have an influence to the seafarer manpower requirements. According to the study, it can lead to diverse requirements for access into different shore-based sectors and seafarer have difficult to enter these positions due to the qualification level required. [2]

Several research has been made about women working at sea and their career in male dominated environment. As example of this is a bachelor thesis *Female master mariner's adjustment to working life* which was made by two female students from Satakunta University of Applied Sciences. According to their study the majority of women end up working ashore not only when starting own family, but also when new interesting job opportunities show up from shore based organizations in maritime industry. One important thing for women in their career making was to have a meaningful and challenging job but salary also play some role. [6]

3 RESEARCH METHODS

This qualitative study collected experiences of Finnish women who work in maritime sector. Study was conducted during spring 2018 by interviewing graduated female alumns from both degree programs Sea Captain and Master of Maritime Management. All participants had seagoing experience at least as a deck officer level and current vacancies were either on ship or ashore such as port or maritime administrations, specialist in maritime technology company or shipowning company. Ages of participants were between 35 and 45 years.

The objectives of this study consisted of five questions:

1. What were reasons originally for you to seek into maritime profession?
2. What were the reasons for you to start studying in the degree program master of maritime management?
3. How has the master of maritime management degree benefit you career development?
4. How could women be encouraged to work in maritime professions?
5. How does gender affect on career development in maritime professions?

3.1 Results of the study

1. Like many other researches have shown, also in this study the reasons for seeking into maritime profession are mostly explained by family member(s) who have worked at sea and have affected this study participant's career choice. Another reason for starting maritime studies was just a general interest toward maritime profession.

2. Second question was about the motives to start further studies in the degree program Master of Marine Management. The reasons for further studies for these women were inclination to continuous self-development and improving their possibilities in labour market by broadening their knowledge and accomplish a higher degree. Often management level positions in maritime industry require a higher educational degree. Alumni women also considered that their education have improved their changes when competing for new vacancies or promotions.

4. According to this inquiry, there should be more information available about the jobs and career possibilities in maritime sector both at sea and ashore. Also sharing of "success stories" and maybe some kind of mentoring system would be beneficiary. On the subject of family and children, women thought that it is possible to combine motherhood and career at sea. To encourage women to seek into maritime career, the participants described maritime profession to be interesting, challenging and requiring many skills. An international environment and workmates from different countries were mentioned as an advantage.

5. Some answerers felt that women still need to be twice as good to be half as appreciated when working in masculine profession. A "good brother" societies are still alive even though the work climate is slowly changing. The other opinions were that gender doesn't affect the career development and they have got promotions as quickly as men. The experience of

Finnish women at maritime sector were that presence of female improves the teamwork and work atmosphere.

4 POSSIBILITIES TO MARITIME POST GRADUATE STUDIES IN FINLAND

Satakunta University of Applied Sciences started to develop a Master of Maritime Management programme in the beginning of 2000 decade. This Master programme has been especially tailored to meet women's demand for a work in a land-based organization and one of the main targets of the programme is to generate equality of women seeking to maritime professions. If there is no clear "career-bridge" from ship to shore, it is very difficult to describe the lucrativeness of maritime profession for women in the first place.

Approximately 10 per cent of the graduates are women which is a lot more than women in general in maritime profession. The statistic survey which has been conducted reveals that the motivation among women students in Master Programme is higher and percentage of graduating students is especially high. Almost 100 percent of women who are accepted to the programme also graduate. There is substantial difference to men where the percentage is closer to 50 % than 100 %. Ninety present of women who have graduated, have also moved to land based organizations during next year after graduation.

Flexibility of the study programme has especially benefited women's participation and fast graduation. Most women have already started to seek land based jobs during the studies and most of them have also started to raise family during studies or soon after graduation. Flexibility of the distance studies has also made it possible to study during maternal leave. Before 2000's most women needed to seek other education possibilities and start another career path if they wanted to start working ashore.

As Master of Maritime Management education builds on existing STCW based education, it is a "fast-track" to maritime ashore career compared to all previous possibilities for both women and men – However, in general for women it was more difficult to start studying to another profession as usually the cultural situation before 2000's was that very few men stayed home with children. Now in 2000's with a degree of 60 credits and only approximately 12-15 contact lecture days during the 1,5 years studies, it is relatively easy to organize the studies also for women who often need to manage their families after they have moved from ship to shore.

When the Master of Maritime Management programme has now been firmly established and has been running for 12 years already, it has clearly benefited women's career paths and made it easier to plan it.

5 CONCLUSIONS

The survey which was conducted reveals that many of the women now in profession have a connection to maritime profession already from home (father, relative etc.). If we want to encourage more women to maritime professions, we need to inform also those who do not have this kind of connection and existing knowledge of the profession by family ties. The information and knowledge need to be promoted through schools, internet and social networks.

One of the next steps to be taken is to make it more visible also in the high schools where the pupils are planning their careers in other words women should be able to plan their careers already from the beginning.

Without the knowledge of the possibility of continuing the “seawomens” career ashore after this Master degree as further education, many possible women might be lost to other professions, if they are not able to visualize the combination of career at sea, career ashore and building a family align with the maritime profession.

The women who work in maritime professions should justified be more visible and serving as examples for girls and women instead of hiding in masculine working environment and just trying to be “one of the guys”.

REFERENCES

- [1] Grant, Claudia Grant and Vivette. Women in the Maritime Sector: Surviving and Thriving in a Man’s World - A Caribbean Perspective. [book auth.] WMU. [ed.] Momoko Kitada, Erin Williams and Lisa Loloma Froholdt. *Maritime Women: Global Leadership*. New York Dordrecht London : Springer-Verlag Berlin Heidelberg, 2015, Vol. 3, p. 90.
- [2] European Community of Shipowners Association & European Transport Worker’s Federation. *The mapping of career paths in the maritime industry*. pp. 148-150.
- [3] Lisa Loloma Froholdt, Erin Williams, and Mokomo Kitada. Introduction. [book auth.] WMU Studies in Maritime Affairs 3. *Maritime Women: Global Leadership*. s.l. : Springer, 2015, Vol. 3, p. 1.
- [4] International Maritime Organization (IMO). Women in the maritime industry. *International Maritime Organization*. [Online] 2018. [Cited: 23 5 2018.] <http://www.imo.org/en/MediaCentre/HotTopics/women/Pages/default.aspx>.
- [5] Kitada, Mokomo. *Women Seafarer and their Identities (Doctoral dissertation)*. Cardiff : School of Social Science, Cardiff University, 2010. Doctoral Thesis.
- [6] Peippo, Anu and Zilliacus, Mona. *Female master mariner’s adjustment to working life*. School of Maritime Management, Satakunta University of Applied Sciences. Rauma : Satakunta University of Applied Sciences, 2007. p. 55, Bachelor Thesis.

THE EVOLUTION OF FEMALE FIGURES IN MET INSTITUTIONS OVER A DECADE: SOME CASE STUDIES

CLÀUDIA BARAHONA-FUENTES¹, MARCEL·LA CASTELLS I SANABRA²,
SANTIAGO ORDÁS JIMÉNEZ³ AND JORDI TORRALBO GAVILÁN⁴

¹Department of History and Theory of Architecture and Communication Techniques
Barcelona School of Nautical Studies (FNB)
Universitat Politècnica de Catalunya – BarcelonaTech
Pla de Palau, 18, 08003 Barcelona, Spain
e-mail: claudia.barahona@fnb.upc.edu, <http://futur.upc.edu/ClaudiaBarahonaFuentes>

Department of Nautical Science and Engineering
Barcelona School of Nautical Studies (FNB)
Universitat Politècnica de Catalunya – BarcelonaTech
²e-mail: mcastells@cen.upc.edu, ³e-mail: sordas@fnb.upc.edu, ⁴e-mail: jtorralbo@cen.upc.edu

Keywords: Maritime education and training (MET), female students, women promotion policies, gender equality, role of women in the maritime sector, women professional career

Abstract. Although the figures of female students in technical studies have increased in recent years, in MET male students still greatly outnumber female ones. This inequality is transferred to the maritime professional sector, where the proportion of women in different types of jobs and management positions is still far from the desirable expectations. This study analyses the enrolment and graduation figures of female students in several MET institutions over the last decade (2009-2018) with the aim of providing a better understanding of the current situation. This analysis also considers the gender policies applied in the different centres over the same period of time to determine their effectiveness over female student enrolment. The results reveal that this gender imbalance persists in all the institutions analysed and that there is no evident raising trend concerning the figures of female students enrolled and graduated over the last decade for the centres examined. In addition, gender equality promotion policies are still scarce or inexistent and have had a limited effect on female enrolment figures. Thus, it can be concluded that much remains to be done to improve the present situation and to overcome this gender gap in MET. Some proposals presented in this paper include the joint development of gender equity policies by national maritime administrations and international maritime organisations and agencies, the incorporation of female student promotion policies at earlier educational stages and the analysis of female students' expectations and motivations for choosing maritime studies.

1 INTRODUCTION

The limited number of female students enrolled in Marine Engineering and Maritime Navigation studies and the lack of gender-policies in most MET institutions is becoming an

increasing cause of concern in the maritime education sector. Research in the field suggests that this is a widespread problem across countries, which requires immediate attention from the corresponding agents [1, 2, 3]. The proportion of women earning technical degrees has increased steadily during the last decades. However, technical professions, including those in the maritime sector, show a clear gender gap with respect to jobs and managerial positions, namely, both in their horizontal and vertical dimensions [2, 4]. This gender inequity has its roots at university level where male students clearly outnumber female ones, so a better understanding of the current situation may be key to provide a new insight into this problem so that we can find ways to reverse the present numerical inequality and resolve existing gender bias in the future.

Up to the present, several attempts have been made at promoting the incorporation of female students in higher education both at institutional and international level. For example, at international level we find IMO's programme on the Integration of Women in the Maritime Sector (IWMS) whose primary objective is "to encourage IMO Member States to open the doors of their maritime institutes to enable women to train alongside men and so acquire the high-level of competence that the maritime industry demands" [5]. However, most of the times, such programs are addressed to women in developing countries where they have even more difficulties for enrolling in maritime programs. At institutional level, the incorporation of more inclusive gender policies is most of the times dependent on institutional leaders and their awareness and goodwill to address these issues [6] or on individual initiatives. Therefore, although some policies for gender equity have already borne their fruits, we are still far from the intended equity expectations. In addition, increasing numbers of female students is not enough because as some authors point out "without effective gender-inclusive strategies and pedagogical and didactic approaches, there is a risk of reproducing inequality instead of producing equality" [4]. Hence, promotion policies for incorporating more female students in maritime training is only the first step, and should go hand in hand with specially-designed curricula integrating gender issues.

These inequities at training level are reproduced in the professional sector where women are clearly under-represented at all levels. On the one hand, this can be due to the lack of specific policies or regulations with respect to women recruitment and working conditions [7]. On the other hand, the history and legacy of an almost entirely male profession also constitutes a major drawback for the employment of women at sea or ashore and for the construction of a female professional identity [8]. In response to this, different groups and associations have begun to emerge to support women in this sector such as WISTA, a Women's International Shipping and Trading Association, which attracts and promotes women, at the management level, in the maritime, trading and logistics sectors.

2 METHODOLOGY

This paper describes a small-scale study concerning the figures of female student enrolment and graduation in some MET institutions and their evolution over the last decade (2009-2018). The participating centres are all Higher Education Schools of Maritime Studies, namely, thirteen schools in ten different European countries, two in South America and one in Africa (see Table 1). The last three institutions were included within a group of non-European countries. This way, European countries and non-European countries were analysed separately.

The group of European universities comprises three schools in Spain, which were also considered independently in this research to contrast Spanish and European outcomes. With the collaboration of all the MET centres participating in the study, we gathered data corresponding to access and graduate figures of female students since 2009, which were examined in order to discover any trend or general pattern of evolution. With the aim of providing some tentative explanation on the findings, we also requested information concerning the implementation of institutional policies aiming at gender equality and university groups promoting those policies in the mentioned institutions.

| Country | Institution | Identifying acronym |
|-------------------------------|------------------------------------------------------------------------|---------------------|
| European countries | | |
| Belgium | Antwerp Maritime Academy | HZS |
| Croatia | University of Split, Faculty of Maritime Studies | US FMS |
| Finland | Satakunta University of Applied Sciences | SAMK |
| Montenegro | University of Montenegro | UCG |
| Norway | Western Norway University of Applied Sciences | HVL |
| Poland | Gdynia Maritime University | GMU |
| Poland | Szczecin Maritime University | SMU-P |
| Romania | Constanta Maritime University | CMU |
| Slovenia | University of Ljubljana | UNILJ |
| Sweden | Chalmers University of Technology | SMT-CUT |
| Non-European countries | | |
| Spain | Universidad de Oviedo, Escuela Superior de la Marina Civil | UNIOVI |
| Spain | Universidad del País Vasco, Escuela de Ingeniería de Bilbao | UPV/EHU |
| Spain | Universitat Politècnica de Catalunya, Facultat de Nàutica de Barcelona | UPC-FNB |
| Egypt | Arab Academy for Science, Technology and Maritime Transport | AAST-MT |
| Perú | Universidad Tecnológica de Perú | UTP |
| Uruguay | Escuela Naval de Uruguay | ENU |

Table 1: Participating institutions

All the participating institutions were sent a form they completed with the total number of students and the number of female students enrolled and graduated since 2009. The same form included some space for describing the female student promotion policies applied in their schools during those years. With the data gathered, the percentages of female students enrolled and graduated each year was calculated for each university and plotted on a graph to determine any possible similarities and differences. Then, the mean value of all the percentages from the different institutions for each academic year was calculated to observe any possible global trend. Here, we considered European universities, including also the results from Spanish schools, and then compared the European global trend to the Spanish one. The mean values for these two groups were also plotted on graphs to detect any tendency over the last decade.

3 RESULTS AND DISCUSSION

The results of this study are grouped into two main areas; namely, evolution of access and graduation figures of female students of all the universities analysed and effects of the institutional policies for engaging female students.

3.1 Access and graduation figures of female students in MET institutions

The access and graduate figures for female students in all the universities analysed show that there is still a small percentage of them that begin and complete their training in MET institutions during the period evaluated and that the situation does not improve over time. In the graphs on enrolment figures, it can be noted that the number of women that begin Nautical Science and Maritime Transport Studies is considerably higher than that of women beginning Marine Engineering Studies in all universities except for the Universidad Tecnológica del Perú and Arab Academy for Science, Technology and Maritime Transport (see Figure 1).

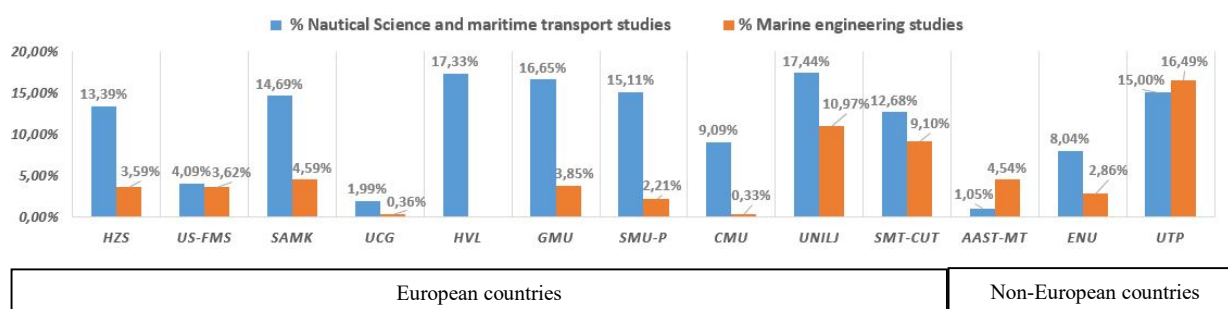

Figure 1: European and Non-European countries - Average of enrolled 1st year female students (2009-2017)

If we consider these enrolment figures over time, that is, the mean enrolment values of all European universities for each academic year, a similar trend can be observed¹ (see Figure 3). It is noteworthy that, contrarily to our expectations, an upward trend cannot be appreciated over that period. The mean values for all the European institutions, including Spain, show that the access figures of female students in Nautical Science and Maritime Transport Studies is 13.50% whereas in Marine Engineering Studies decreases to 6.25%.

With respect to the figures of graduated female students, the results display a similar tendency (see Figure 2). The mean values of graduated female students from all European institutions distributed over academic years, in the same way as with access figures, reflect no gradual increase, only some occasional rise (see Figure 3). Over this ten-year period, the mean value of graduated female students in Nautical Science and Maritime Transport Studies is 15.88% whereas in Marine Engineering Studies is 5.92%. As can be noted, the graduation figures for Nautical studies are slightly higher than those for enrolment whereas in Marine Engineering figures stayed level. Since these percentages are calculated over the total number of students enrolled and graduated, a possible interpretation could be that fewer girls than boys abandon their studies in Nautical science and Maritime Transport.

¹ In the graphs that show the development of figures over time, only European Universities, including Spanish universities, were surveyed. Non-European universities were not considered for this analysis as three institutions do not constitute a representative sample.

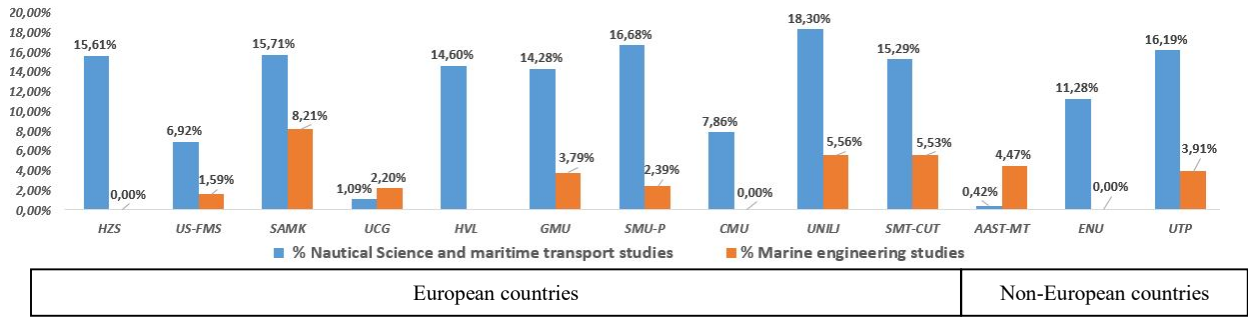

Figure 2: European and Non-European countries - Average of graduated female students (2009-2017)

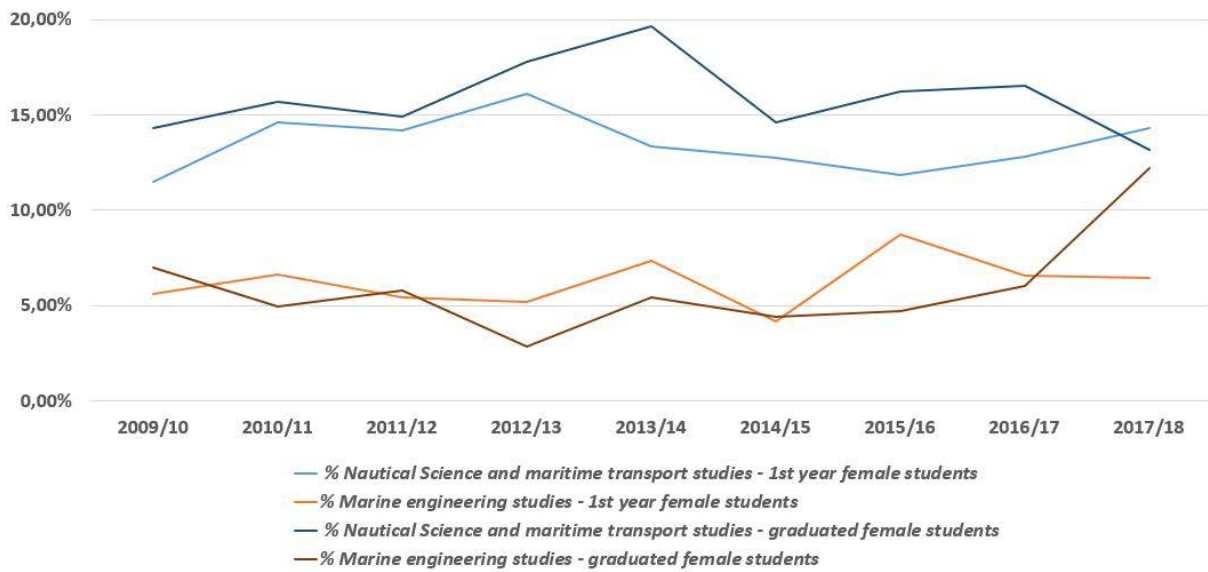

Figure 3: European countries - Average of enrolled 1st year female students and graduated female students (2009-2017)

Considering Spain separately, with respect to the three schools examined, it can be seen that, on average, there is a higher percentage of girls in these studies in Spain than in the rest of European countries (see Figure 4).

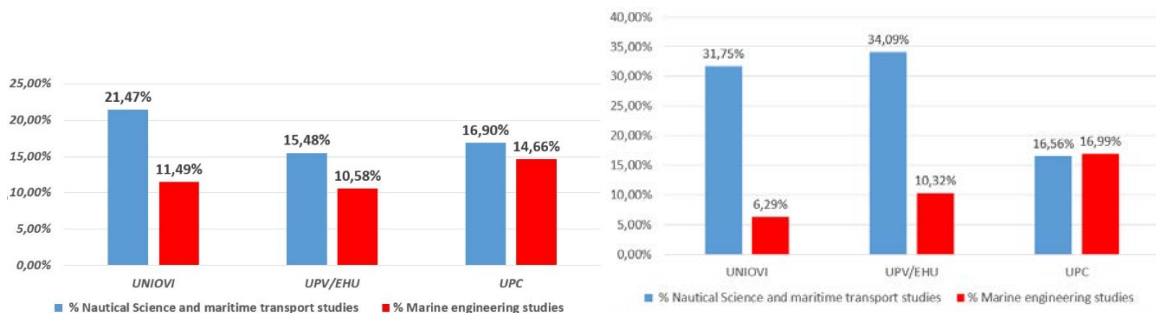

Figure 4: Spain - Average of enrolled 1st year female students (2009-2017)

Figure 5: Spain - Average of graduated female students (2009-2017)

Analysing enrolled female students over the last decade, the tendency in Spain is the same as that observed for European countries (see Figure 6). Here again there is no significant increase over this period. The mean access value of female students in Nautical Science and Maritime Transport Studies is 17.95% and 12.24% for Marine Engineering Studies. In line with this, the figures of graduated female students in Spain follow the same pattern (see Figures 5 and 6). For graduated Nautical Science and Maritime Transport female students the mean value is 27.47% and for graduated Marine Engineering female students is 11.20% over this last decade. In the case of Spain, the only significant difference as compared to the mean values of European countries is that although there is also an increase on the graduated figures for Nautical Science and Maritime Transport studies, with respect to access figures, Marine Engineering studies show a reverse tendency, which means that more girls than boys abandon these latter studies.

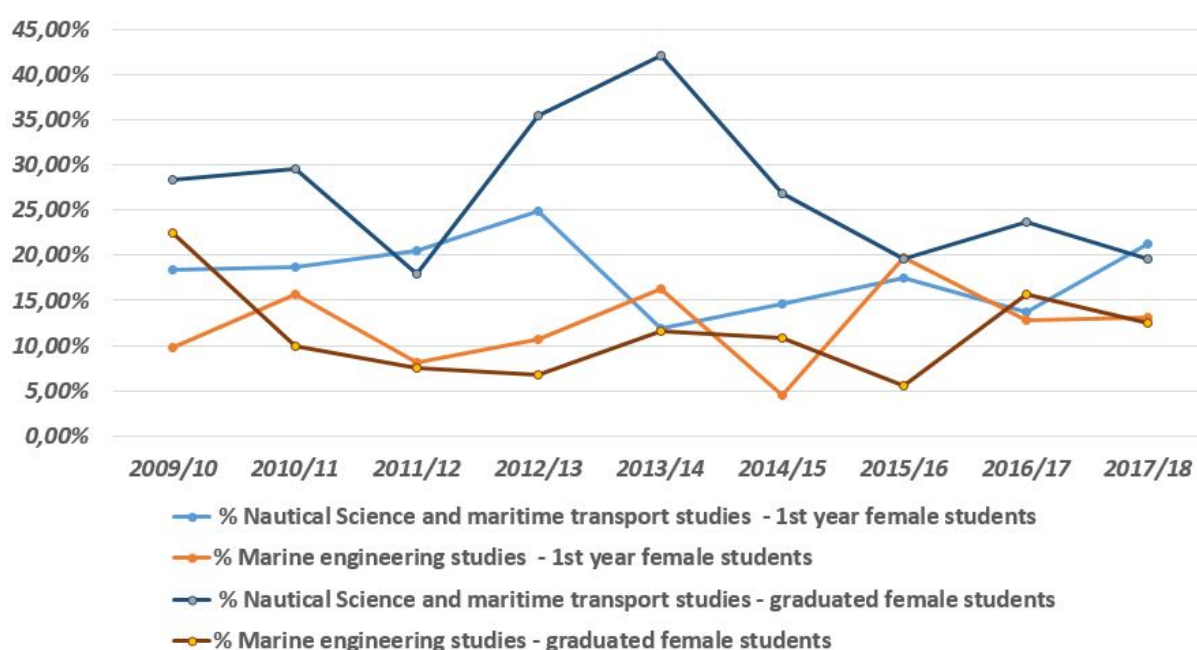

Figure 6: Spain - Average of enrolled 1st year female students and graduated female students (2009-2017)

3.2 Institutional policies for engaging female students

In the majority of countries analysed, no promotion policy for female students in Maritime studies was implemented over the period studied except for Szczecin Maritime University and Universitat Politècnica de Catalunya. Szczecin Maritime University obtained two promotion projects financed by the EU during 2011-2013 and part of the budget had to be obligatorily addressed to women. As a result, there was a general increase in admissions and also in the number of female students admitted those years. Universitat Politècnica de Catalunya also launched the I Equal Opportunities Master Plan in 2007 with the general aim of promoting a culture of equity and equality of opportunities for women. Among some more specific objectives, there was promoting a balance between men and women in the different UPC engineering studies. The I Plan lasted for two years and then during the period between 2013-

2015, the II Plan was implemented [9]. Since 2016, the III Plan for Gender Equality is in place. In this occasion, this is not a plan particularly addressed to Maritime studies, but to engineering studies in general. However, Barcelona School of Nautical Studies also benefited from all these promotion policies and slightly increased the number of female students enrolled when the plan was launched [10].

4 CONCLUSIONS

The findings and observations of this study illustrate how the gender gap in maritime education and training continues in all the institutions analysed over the last decade. Female student figures have the lowest percentages in all studies and in the case of Marine Engineering degrees girls seem to abandon their training more frequently than boys. Nautical Science and Maritime Transport studies are, in general, the ones with higher percentages of female students and also the ones with a lower dropout rate. All the same, it is important to point out that, concerning the mean value of female students enrolled and graduated in Maritime studies in some European MET universities between 2009 and 2018, there is no significant raising tendency for any of the studies examined. It is unclear, however, to what extent these results reflect an actual current trend as a wider sample of MET institutions would have to be surveyed.

In spite of an increasing awareness and some isolated efforts to reverse this gender gap situation [11] [12], female student policies are still scarce or non-existent in most institutions. Gender issues seem to be entirely dependent on institutional leaders who are favourable to set guidelines for more inclusive gender-policies. This awareness and willingness to change policies is welcome but it is not enough. If there isn't a perception of having a real problem, possible solutions won't be addressed and there is an urgent need for a new push to overcome gender imbalance and guarantee the success of gender equity. Therefore, a more in depth analysis and a wider applicability of such policies is required, even across countries, as most of the times they work only at national or institutional level. There have already been some attempts at implementing international programmes to promote gender equality and women advancement, for example by the UN and the IMO among others [13]. In line with this, the joint involvement of national maritime administrations and international maritime organisations and agencies in the development of gender equity policies might be an important and more effective step towards developing a more egalitarian and inclusive maritime education and training system.

Furthermore, this study does not include other considerations of gender discourse or pedagogy in the institutions analysed as it is not within the scope of the present study, but this is also something that would demand attention if we are willing to resolve the present gender gap situation [4]. Increasing the numbers of female students is not enough if it does not go hand in hand with changes in the pedagogy and the curricula of MET institutions as the weight of the male-dominated cultural and historical maritime context will be otherwise difficult to overcome.

Finally, this paper also raises a broader question: When should promotion of maritime studies begin among prospective female students? Beginning promotion at university level might be too late, as female students may have already anticipated more humanistic degrees. Thus, starting promotion in secondary, and even primary, education could be a more successful

attempt to obtain better results to leave behind the present gender inequality in maritime studies. This is closely related to students' expectations for choosing maritime studies [14] [15]. If we try to better understand female students' expectations and motivations for choosing these studies, we will be able to design better promotion policies and strategies and we can even try to implement them at earlier educational stages.

ACKNOWLEDGMENTS

We greatly acknowledge the Higher Education Schools of Maritime Studies (HZS, US_FMS, SAMK, UCG, HVL, GMU, SMU-P, CMU, UNILI, SMT-CUT, UNIOVI, UPV/EHU, UPC-FNB, ASST-MT, UTP, ENU, UMIP) and the Spanish Maritime Administration (DGMM) for their support throughout this MET gender study.

REFERENCES

- [1] Universitat Politècnica de Catalunya, BarcelonaTech (UPC). *I Pla Director d'Igualtat d'Oportunitats 2007-2010. Annex I – Evolució demogràfica de gènere*. Barcelona: 2007.
- [2] De la Campa, R.; Bouza, M.A.; Estopá, H. and Alcolea, R.M. The role of Spanish women in the merchant marine in XXI century. In: *2013 International Conference Proudly Empowering Women in Maritime: May 2013, Barcelona, Spain, 29-50*. ISBN 9788476539996.
- [3] Romero Lares, M.C. and Kitada, M. An overview of the United Nations millennium development goal on gender equality and empower of women (in the maritime sector). In: *2013 International Conference Proudly Empowering Women in Maritime: May 2013, Barcelona, Spain, 18-28*. ISBN 9788476539996.
- [4] Boström Cars, M. and Österman, C. Mind the gap! Maritime Education for gender-equal career advancement. In: *Maritime Women: Global Leadership: 143-154*. 2015, Berlin, Heidelberg. https://doi.org/10.1007/978-3-662-45385-8_11
- [5] International Maritime Organization (IMO). *Strategy on the Integration of Women in the Maritime Sector (IWMS). IMO'S Women in Development Programme*, 1989.
- [6] Universitat Politècnica de Catalunya, BarcelonaTech (UPC). *III Pla d'Igualtat de Gènere de la UPC, 2016-2020*. Barcelona: 2016.
- [7] YaleGlobal Online. *Tough Struggle at sea*. [online]. Yale: YaleGlobal Online, 2003 [viewed date 17 June 2018]. Available from: <<https://yaleglobal.yale.edu/content/tough-struggle-sea>>

- [8] Walker, C.; Gleaves, A. and Peart, D. Problems in the Construction of Gender and Professional Identities for Women in a United Kingdom Merchant Navy Training School. *Research in Post-Compulsory Education*. Taylor & Francis, 2003, **8**(3), 285-304. ISSN: 1359-6748
- [9] Universitat Politècnica de Catalunya, BarcelonaTech (UPC). *II Pla d'Igualtat de Gènere de la UPC, 2013-2015*. Barcelona: 2013.
- [10] Martínez de Osés, F.X. *Situación de la mujer ante los estudios marítimos y la marina Mercante* [online]. Barcelona: UPC [viewed date: 17 June 2018]. Available from: <<https://upcommons.upc.edu/bitstream/handle/2117/561/La%20mujer%20en%20la%20Marina%20Mercante.pdf>>
- [11] Kitada, M.; Williams, E. and Froholdt, L.L. (Eds) *Maritime Women: Global Leadership*. WMU Studies in Maritime Affairs, Springer. 2015. ISBN 978-3-662-45385-8.
- [12] Hork, J. The gender perspective in maritime education and training. *WMU Journal of Maritime Affairs*, April 2010, **9**(1), 93–119.
- [13] Romero Lares, M.C. A Case Study on Gender Equality and Women's Empowerment Policies Developed by the World Maritime University for the Maritime Transport Sector. *TransNav, the International Journal on Marine Navigation and Safety of Sea Transportation*. Faculty of Navigation, Gdynia Maritime University, December 2017, **11**(4), 583-587. ISSN 2083-6481.
- [14] Pallis, A. A. and NG, A.K.Y. Pursuing maritime education: an empirical study of students' profiles, motivations and expectations. *MARIT. POL. MGMT*, July 2011, **38**(4), 369-393.
- [15] Ku, K-N. *et al.* Factors Affecting Female Students' choice of Maritime Majors. *Journal of Marine Science and Technology*, 2017, **25**(4), 417-423. DOI: 10.61. 9/JMST-017-0322-1

WOMEN IN THE MARITIME INDUSTRY

ALINA BALASANYAN

LEPL – Teaching University - Batumi State Maritime Academy (BSMA)
53 Rustaveli St., 6010 Batumi, Georgia
e-mail : alinabalasanyan1@gmail.com, <http://www.bsma.edu.ge/>

Z. PHUTKARADZE

Academician of GAAS, Head of the Scientific Advisory Center of Ajara, Professor of BSMA
53 Rustaveli St., 6010 Batumi, Georgia
e-mail: z.futkaradze@bsma.edu.ge, <http://www.bsma.edu.ge/>

Keywords: IAMU 2018, Barcelona, the maritime industry, Gender Balance

Abstract. Maritime industry plays an essential role in development and sustainable progress of the modern world. Almost each country of the world depends on maritime-based providing export and import of necessary goods. Thus, maritime transport is the most essential part of global the trade and the global economy.

The main aim of the research is to analyze the prospects of women involvement into such important sector, identifying existing difficulties and problems, focusing on the current situation. Finally, we'd like to propose the ways to make this activity more suitable and attractive for women, fixing on the job opportunities .

Marine industry offers a wide range of job opportunities (including shipbuilding, shipping and management) for employers and improves the standards of living in the industrialized and developed world. However, even a brief review shows that it is a male-dominant sector of industry. The reasons for this phenomenon are mainly caused by social, cultural and religious traditions established thousands years ago. Years ago, the main obligation of women was to be a housewife, but currently the role of women in society is changed and no longer women want to be discriminated. Involvement into maritime industry provides many benefits for women, such as good salary, business and social contacts with different people and cultures and there is no reason to block female employment in maritime industry of the twenty first century.

Thus, in order to promote the role of women in maritime industry, The International Maritime Organization (IMO), in support of International Women's Day 2015 launched the video "Making Waves: women leaders in the maritime world"[1].

Accordingly, a powerful shift towards promotion of involvement of women to marine industry was provided, assisting females all over the world to find their ways in the world of equal opportunities.

1 INTRODUCTION – A GENERAL REVIEW OF THE MODERN SHIPPING INDUSTRY

Maritime industry is one of the oldest industries in the world still playing the leading role in sustainable development of modern societies. It is an essential element in terms of social and economic growth, currently employing several million people (in direct and indirect maritime-related spheres) at the same time also providing a stable and annually rising source of employment and career opportunities. Modern shipping has been the major and the most effective form of transportation, as well as an essential link connecting coastal cities, countries and continents. Immediately after rail transportation, shipping is economically and environmentally the most efficient way to travel or carry different types of goods. Presently, about 90% of world trade is provided by the international shipping industry, which therefore ensures a wide range of job opportunities, presented by sea and shore based ones.

Men traditionally dominate maritime industry. Despite that women form 39.3% of the global workforce, women seafarers constitute only 2% of the total number of seafarers worldwide [2]. Their low number in the sector means that women can be subject to discrimination and harassment. Thus, traditionally male-dominated industry has firstly to overcome centuries-backed gender stereotypes and setbacks and to accept women as the equal partners in the industry development sphere.

The international efforts are ongoing to minimize this inequality in the maritime and it is a step in the right direction for the whole world. For generations, women were traditionally seen as mothers, teachers, homemakers whose obligation was only to stay at home and look after the kids while their husbands earned money. This is no longer the case, as mothers seek careers of their own, firstly because they want to, a woman no longer wants to be the housewife and secondly, because, these days, families need two incomes due to the rising cost of living. Gender gaps remain one of the most pressing challenges facing the world of work.

2 THE RESEARCH AIMS

- an overview of women in the maritime industry
- to survey difficulties, problems and hindrances encountered by women in the maritime industry.
- to survey the present situation and the future role of women
- to identify international and national initiatives to encourage the participation of women in the industry

3 AN OVERVIEW OF WOMEN IN THE MARITIME INDUSTRY

The 19th century sailing vessel was a male dominated and defined world, yet women are assuredly part of this rich history. United Nations has begun the program in the 1976, the goal of which was the promotion of equal rights and opportunities for women around the world, to achieve international co-operation in promoting and encouraging respect for human rights and for fundamental freedoms for all without distinction as to race, sex, language, or religion. The UN Decade for Women and its conferences helped in 1975 in Mexico City to establish the legitimacy of women's issues regarding their roles as workers in the home and outside it. Nevertheless, women hold positions only in service departments.

According to ILO publication “Women seafarers: Fighting against the tide? As on land, so by sea: Women join the ranks of seafarers” for 2013 year women represented only 1-2 per cent of the world's 1.25 million seafarers. However, in the cruise line sector, they represent 17-18% of the workforce. Ninety-four per cent of women are employed on passenger ships (with 68% on ferries and 26% on cruise ships) and 6% are employed on cargo vessels. As for jobs, there are women shipmasters and chief engineers, as well as other officers. However, generally, women are working as hotel staff on passenger ships. Of this latter group, 51.2% of women at sea come from OECD countries, 23.6% from Eastern Europe, 9.8% from Latin America and Africa, 13.7% from the Far East, and 1.7% from south Asia and the Middle East [3].

4 THE MAIN REASONS WHY MANY FEMALE CANDIDATES ARE REFRAINING FROM ENTERING THE MARITIME INDUSTRY:

4.1 Gender discrimination

Shipping has historically been a male dominated industry and that tradition runs long. Many women fear to enter the man's world, as they believe that they might face physical harassments, violence and the low levels of support from co-workers.

4.2 Social, Cultural and traditional views. Family roles

Women in some societies are unfortunately considered as inferior to men. On this basis, some parents refuse to send their female children to school, not to “waste of money and time”. They believe the top of female career is to enter into marriage. Similarly, many women are not allowed to choose shipping as a career because of the long stay at sea. Being on-board for several months might not satisfy the social role of a woman, making it an unattractive field of employment.

4.3 The attitude of crews and officers in the male world

Women working in a predominantly male environment may become a subject of discrimination, sexual harassment, bullying and violence in their workplace on board ship

5 PROMOTION AND JOB OPPORTUNITIES.

The difficulty of getting access to jobs and professional development in the maritime industry is also a reason for less women seafarers in the maritime sector. Lack of workplace support keeps women out of this career.

Shipping jobs has been classified as one of the ten most dangerous jobs in the world. There are many difficulties attached with job. Some of them are presented with health issues and strict physical fitness, unsettled lifestyle, complex and hazardous machinery, lack of social life and away from family. It is difficult not only for women, but for men also. However, I want to mention, that maritime industry is very wide field, suitable for both.

Examples of some typical shore based career opportunities include:

- maritime environment/resources management and protection
- ship broking and finance
- the design and building of ships
- maritime law and arbitration
- ship management and fleet operations
- ports and harbour management and pilotage
- ship repair and marine equipment production
- marine insurance
- offshore exploration
- lecturer in college, training of personnel in the maritime industry
- International initiatives to encourage the participation of women

6 INTERNATIONAL INITIATIVES

One of the initiatives is IMO's **Programme on the Integration of Women in the Maritime Sector (IWMS)**. IMO was in the vanguard of United Nations (UN) specialized agencies in forging a realistic programme for the Integration of Women in the Maritime Sector (IWMS), grounded in the vision of equality enshrined in the United Nations Charter, at a time when few maritime training institutes opened their doors to female students. IMO in 2015 launched the video "Making Waves: women leaders in the maritime world" in support of International Women's Day 2015. The video reports on continuing efforts by IMO and the World Maritime University (WMU) to promote the advancement of women in shipping [4].

The International Labour Organization also improves women's access to employment, training, and their conditions of work and social protection. ILO also took some declarations and resolutions to destroy the stereotypes of female and male labour.

A big role in encouraging women in the maritime industry is WISTA. Formed in 1974, the Women's International Shipping & Trading Association is a global organization connecting female executives and decision makers around the world. WISTA International serves as a connector for its network of more than 3,000 female professionals from all sectors of the maritime industry [5].

The main institutional initiative on women in the maritime industry belongs to World Maritime University. In March 2015 the book "Maritime Women: Global Leadership" was published, which highlights the achievement of women in the maritime sector, women's leadership and service to the sustainable development of the maritime industry.

Women in the Class of 2014 were inspired to form the WMUWA due to the Maritime Women: Global Leadership (MWGL) International Conference hosted by WMU in partnership with the International Maritime Organization (IMO).

The University was founded in 1983 and that time women made up only two per cent of the Malmö MSc enrolment. Nowadays 30 per cent of the students are female and in the Shanghai MSc programme this year, over 60 per cent of the students are female[6].

WOMEN IN THE MARITIME INDUSTRY. GEORGIA

Georgia is as Black sea country with four functioning seaports of Batumi, Poti, Kulevi, and Supsa and Port of Anaklia, currently under construction. The national Maritime Authority is represented by Maritime Transport Agency (MTA) responsible for the effective implementation of organizational and legal instruments in the maritime field derived from national and international requirements. I have made research and found out what in my region there is a huge number of seafarers, but the only one active seafarer woman. Natia Labadze is 24 years old officer. She is the first female cadet who graduated from Navigation Educational programme at Batumi State Maritime Academy, Georgia. In her interview, Natia mentioned that she was the only female student among 121 boys at Maritime Academy and remembers fingers directed toward her - with surprised or critical shouting – "girls have nothing to do with sailing".

However, there is gender balance in MTA. It should be highlighted, that director of Maritime Transport Agency is a woman – Tamara Ioseliani. Tamara Ioseliani graduated from Georgian American University (GAU) in 2009 with Bachelor of Legal Science Degree. Between 2005-2009 she successfully completed the series of Law courses at London School of Economics and Political Science (LSE). Since 2010, on behalf of the Government of Georgia she actively participated in the IMO events. Today she is the first female director of MTA.

Nino Gorgoshadze is head of STCW department of MTA Georgia. In the interview Nino mentioned that she finished the secondary school in 1995 and it was not acceptable for female to go to sea by that time. Nino graduated from Faculty of Transport Economy of Batumi State Maritime Academy. Later, despite the fact that she had a family and work in Georgia she started her studies at World Maritime University in Sweden. The head of STCW department finds shipping as a good experience for everyone, without gender differences.

CONCLUSION

There is clear evidence from the research work that, international organizations like the UN, ILO, and IMO use the most machinery available to solve economic, social and cultural problems and promote human rights through the means of treaties, signed instruments and formation of policies, declaration, resolutions and conventions. These are all attempts to fight discrimination against women and integrate them into mainstream maritime activities. Also, there are improvement in women's access to employment, training, social protection and conditions of work. Moreover, participation of women at decision-making level are promoted. However, it is clear that nowadays women have more opportunities to pursue careers in maritime law, shipping business and administrations than was the case 30 years ago. The same progress in the marine sphere should be a desirable outcome for this decade.

REFERENCES

- [1] IMO. International Maritime Organization [online]. London: IMO, 2018. [viewed date 22 May 2018]. Available from: <http://www.imo.org/en/MediaCentre/HotTopics/women/Pages/default.aspx>
- [2] <https://safety4sea.com/the-role-of-women-in-shipping-continues-to-grow/>
- [3] ILO. International Labour Organization [online]. [viewed date 25 May 2018]. Available from: http://www.ilo.org/global/publications/world-of-work-gazine/articles/WCMS_081322/lang-en/index.htm
- [4] IMO. International Maritime Organization [online]. London: IMO, 2018. [viewed date 12 May 2018]. Available from: <http://www.imo.org/en/About/Pages/Default.aspx>
- [5] WISTA. Women's International Shipping and Trading Association [online]. [viewed date 23 May 2018]. Available from: <https://www.wista.net/en/site/about-us>
- [6] WMU. World Maritime University [online]. [viewed date 20 May 2018]. Available from: <https://www.wmu.se/news/press-progress-international-womens-day-2018>

ASSESSMENT AND MANAGEMENT OF RISKS IN THE INDUSTRIAL FISHERY

SERGEY S. MOYSEENKO*, LEONID E. MEYLER*

* Baltic Fishing Fleet State Academy of the Kaliningrad State Technical University
Molodezhnaya Ul., 6, 236029 Kaliningrad, Russia
e-mail: transport@bga.gazinter.net, <https://www.bgarf.ru>

Keywords: Fishing Vessel, Trip Scenario, Risk Assessment, Risk Management

Abstract. One of tasks of maritime education and training (MET) is preparing maritime specialists for risks assessment and management in navigation. A special approach in MET has to be realized in the field of the industrial fishery because specific types of accidents with fishing vessels may be happened there. The effectiveness of the fishing fleet work depends on the quality of management decisions related to the safety of navigation and fishing. The feature of the work of the fishing fleet is that all operations are performed under the influence of many internal and external factors. Risks assessment and management in the industrial fishery can be made at several stages: preparing a fishing vessel for a trip and elaboration its scenario; calculating the acceptable values of the risk and comparing with risk assessments; developing a plan of organizational and technical measures and calculating its implementation cost. An analysis of possible scenarios of the emergency situations development allows to suggest the structure of practice-oriented tasks for the risk management. Risk assessment based on the theory of statistical decisions allows to find the best ways for actions in conditions of uncertainty. The paper demonstrates an example to assessment and management of risks in the industrial fishery.

1 INTRODUCTION

The risk theory both in the financial/economic and technogenic spheres has developed significantly recent years [1]. Since the 70s of the last century much attention has been paid to the development of scientific tools and technological support of the theory of risks. In particular, the International Maritime Organization (IMO) has adopted a manual on Formal Risk Assessment (FSA) in navigation [2]. Risk management has become objectively necessary in many key areas of activity including human activities at sea. The activity in the area of shipping and the industrial fishery has a risk-bearing character. On estimation of the Food and Agriculture Organization of the United Nations (FAO) [3]: “Fishing at sea is probably the most dangerous occupation in the world. Over 24,000 fishermen die every year. The degree of danger is in part a function of the options of fishers’ choices about the risks

they take, such as the weather they fish in, the boats they use, the rest they obtain, and the safety gear they carry. How fisheries are managed may affect the options of fishers and trade-offs as they make these choices – thus affecting the safety of the fishery”. There are a number of economic, environmental, regulatory, and cultural conditions that can influence fishermen’s safety. One way to identify the major hazards and safety patterns present within a fishery is to conduct a risk assessment of that fishery. The results of this assessment can then be used to inform the development of tools and programs designed to reduce fishermen’s level of risk exposure in that fishery [4].

Thus, forecasting, assessing and managing risks become a vital necessity. The fulfilment of these functions requires special training maritime specialists. In this regard the organization of training in the field of risk management is an urgent task that will increase the level of professionalism of maritime professionals and the shore personnel involved in the process of organizing shipping and fishing.

2 IDENTIFICATION OF RISK TYPES IN THE INDUSTRIAL FISHERY

The specifics of fishing incidents are determined by the specifics, the state of the environment and often extreme working conditions (hurricanes, storms, fogs, etc.) of the fishing fleet. According to the review [5] fishing vessels have the second place after cargo ships with total losses over the past decade (Table 1).

Table 1: Annual fishing vessels losses

| 2007 | 2008 | 2009 | 2010 | 2011 | 2012 | 2013 | 2014 | 2015 | 2016 | Total |
|------|------|------|------|------|------|------|------|------|------|-------|
| 34 | 36 | 29 | 21 | 14 | 12 | 13 | 15 | 15 | 9 | 198 |

The scope of the analysis [6] was the detection of potential safety issues concerning marine casualties and incidents that involved fishing vessels with the length over all greater than or equal to 15 meters that occurred between June 2011 and August 2017. More than 2,400 occurrences were investigated for “Casualty with a ship” and “Occupational accident”. Results of studying these safety areas are shown in Table 2.

Table 2: Casualties with vessels and occupational accidents

| Casualty type | Lives lost | Vessel sunk | Accident type | Lives lost | Injured people |
|-------------------|------------|-------------|--------------------------|------------|----------------|
| Collision | 46 | 21 | Fall of persons | 20 | 227 |
| Listing/Capsizing | 45 | 14 | Shock, fright, violence | 0 | 6 |
| Vessel foundered | 39 | 44 | Other | 2 | 64 |
| Grounding/Contact | 16 | 17 | Loss of control | 10 | 209 |
| Flooding | 9 | 31 | Gas or liquid effects | 5 | 34 |
| Loss of control | 6 | 10 | Electrical problem, fire | 0 | 5 |
| Damage to vessel | 3 | 3 | Breakage, bursting | 4 | 99 |
| Fire/Explosion | 3 | 15 | Body movement | 8 | 250 |

The number of accidents in the first half 2018 with Russian fishing vessels [7] was already 22 cases while in 2017 and 2016 for 35 cases, 23 in 2015, 9 in 2014 and 16 in 2013. Total losses of vessels were as follows: in 2010 - 6; in 2011 - 6; in 2012 - 7; in 2013 - 2; in 2014 -

1; in 2015 - 4; in 2016 – 2; in 2017 – 3; in the first half 2018 - 1.

A fishing vessel operates usually at limited water areas with a large number of other vessels. As it is seen in Table 2 the main types of accidents with fishing vessels are the same as for other vessels. But there may be also specific types of accidents such as: snagging of fishing gear and their loss; failure of a hydroacoustic equipment; loss of fishing gear with the hook on reefs or underwater rocks; winding nets or ropes on the screw; pile when mooring the board of a transport ship, etc. It should be noted that the probability of emergencies and accidents with fishing vessels is higher than with transport/merchant vessels. This is evident from the fact that the work of the fishing vessel includes such stages as a trip to a fishing ground, catching, loading, unloading and bunkering operations, etc. directly at sea. Risks that may arise for the fishing vessel during these operations are recommended to assess and identify when preparing the vessel at a port to the fishery, as well as to define cause-effect relationships.

Risks assessment and management in industrial fishery can be realized at several stages.

At the first stage, it is necessary to determine the composition and to analyze the information needed to know conditions of the forthcoming trip and to study previous accidents at the areas of navigation and fishing. The following differentiation of sources of causes of emergencies is suggested:

- the human factor as a source of accident causes is characterized by the skill level of operators (navigators, pilots, dispatchers, etc.) and the level of their psychophysiological stability;
- technogenic factors which are characterized by technical condition of the vessel, machinery and mechanisms, navigation and fishing equipment, etc.;
- hydrometeorological and oceanological conditions [8].

At the second stage, a scenario for the trip of the fishing vessel is developed. The stages of the trip are considered in the context of "sources of accidents - causes - risks - possible consequences". A set of processes and conditions with logical links between them represents a generalized model (scenario) of arising and developing emergencies and accidents with the fishing vessel. This scenario includes the following main stages: preparation the vessel at the port for work when fishing; the trip of the vessel to the fishing ground; searching fish schools, fishing (catching); loading /unloading and bunkering at sea; transportation the catch to the transport/refrigerating ship or to the port. An example of such scenario (not full) with some stages is presented in Table 3. Then an analysis of the scenario is carried out. It allows to identify possible risks during the forthcoming trip. Risk priorities (ranking) are defined. Qualitative and quantitative risk assessments are determined. An integral risk assessment is calculated. An example of calculating risk assessments is given below.

Table 3: Example of a fishing vessel trip scenario, sources and consequences of emergencies/accidents

| Stage | Accidents source | Causes | Type and character of risks | Possible consequences |
|--------------------|-------------------------------------------------|-----------------------------------------------------------------------------------------------------|-------------------------------------------|--------------------------------------------------------------------|
| 1. Port, roadstead | 1.1. Improper technical condition of the vessel | 1.1.1 Appearance of a hull leak; ballast-drainage system failure; misclosure of holds hatch covers; | Outside/rainwater inflows in compartments | Flooding compartments/ sinking a vessel; damage of the cargo |

| | | Table 3 continuation | | |
|-----------------------------|----------------------------------------------------------|---------------------------------------------------------------------------------------------------------------------------------------------------------------------|-----------------------------------------------------------------------------------------------------------------------------|---------------------------------------------------------------------------------------------------------------------------------|
| | | 1.1.2 Damage of electrical wiring, cables, low insulation of electric motors, oil leaks, etc. | Burning oil products or other materials | Fire. Burnout of compartments or completely the vessel |
| 2. Trip to a fishing ground | 2.1 Technical conditions of the vessel (hidden defects). | 2.1.1 The same as 1.1.1, 1.1.2 | | |
| | | 2.1.2 Main engine, steering, radio navigation equipment, radar failures | Loss of maneuverability, reducing the level of information support of a vessel navigation | Collision, grounding, flooding, shipwreck |
| | 2.2 Hydro-meteorological conditions | 2.2.1 The same as 2.1.2 | | |
| | | 2.2.2 Damage of hatch covers. Destruction of vessel structures (bulwarks, illuminators, etc.), deck machinery and mechanisms, life-saving appliances (boats, rafts) | Breakdown of tightness and strength of the vessel; Loss of stability of the vessel | Flooding holds, destruction of the hull. Shift, damage/loss of cargo. Critical state of the vessel and crew. Loss of the vessel |
| 3. Fishing | 3.1 The same as 1.1; 2.1 | The same as 1.1.1; 1.1.2; 2.1.2 | | |
| | 3.2 Technical condition of the radio facilities. | 3.2.1 Failure of radionavigation equipment and radiolocation station of echo sounders, hydroacoustic stations. | Difficulties in determining the location of the vessel. Loss of information about the fishing object, the ground condition. | Damage or loss of fishing gear |
| | | 3.3 Organization and management of fish school searching and catching | 3.3.1 Errors of the choice of fishing grounds and vessel maneuvering with fishing gear | Hook of gears on reefs or underwater rocks; winding nets or ropes on the screw; pile when mooring the board of a transport ship |
| | 3.3.2 Maneuvering errors in the group of fishing vessels | | Winding nets or ropes on the screw | Damage of the screw-steering group, loss of speed and control, collision to other vessels, groundings |

At the third stage, the acceptable values of the risk are calculated and compared with risk assessments. A decision on the realization of the trip (or other operations) is made. Proposals to realize organizational and technical measures in order to reduce the level of risk are elaborated in a case of the high risk.

At the fourth stage, a plan of organizational and technical measures is developed and its implementation cost is calculated. Also the effectiveness of the measures is assessed.

3 RISK ASSESSMENT BASED ON THE THEORY OF STATISTICAL SOLUTIONS

The use of this method allows to find the best ways for actions in conditions of uncertainty and the associated risk. The uncertainty is often associated with the state of the nature, i.e. the system “man – technics – nature” in the practice of the industrial fishery. The “nature” is the element of the uncertainty in this chain. Only assumptions about possible states of the nature can be made. Whether the decision is profitable in a particular situation can be determined on the value of the risk. The value of the risk can be defined as the difference between the expected outcome of an activity in the presence of accurate data about the concrete situation and the result that can be achieved if these data are unknown exactly.

Let us consider an example [8]. The trip of the fishing vessel to a fishing ground is planned. The expected situation at sea is uncertain. In particular, there are three variants of weather conditions: W_1 – a variable wind of 2-3 points, W_2 – the North-East wind of 3-5 points, W_3 – the West wind of 4-7 points. Three options for choosing the route: A_1, A_2, A_3 are stipulated. The shortest route is A_3 . Each of these variants will lead to certain results depending on the weather conditions. Data on probabilities of the weather conditions on the routes are given in Table 4. Speeds of the vessel for the given wind strength for each variant of routes are calculated using these probabilities. Also reducing speeds under the action of wind is taken into account.

Table 4: Probability of weather conditions

| Routes | Wind | | |
|--------|-------|-------|-------|
| | W_1 | W_2 | W_3 |
| A_1 | 0.75 | 0.25 | 0.00 |
| A_2 | 0.25 | 0.50 | 0.25 |
| A_3 | 0.00 | 0.30 | 0.70 |

Let us suppose that the speed of the vessel is 15 knots when the “good” weather condition. The route A_1 is 3,300 nautical miles long, the route A_2 is 3,000 miles, and the route A_3 is 2,900 miles. An estimation of the efficiency of the trip routes by the time criterion is given in Table 5. It provides an opportunity to evaluate each variant according to the time criterion under the conditions of the risk caused by weather conditions. The shortest (on the time criterion) route A_2 with the given operating speed of 13 knots is taken as a “standard” variant for the trip. In this case, time required for the trip is equal to 222 hours. The shortest (on the distance criterion) route A_3 takes 284 hours. Therefore, the price of the risk will be in a case of

choosing the shortest route: 222 hours - 284 hours = - 64 hours. The choice without any risk is represented by routes A_1 and A_2 .

Table 5: Estimation of the efficiency of routes

| Routes/ miles | Speed of the vessel, knots | | | Average weighted estimation of the ship speed | Time of the trip |
|------------------|-------------------------------|-------|-------|--------------------------------------------------------|---------------------|
| | W_1 | W_2 | W_3 | | |
| $A_1/3,300$ | 15 | 13 | 9 | 14.5 | 228 |
| $A_2/3,000$ | 15 | 13 | 9 | 13.5 | 222 |
| $A_3/2,900$ | 15 | 13 | 9 | 10.2 | 284 |

The choice of the best solution in conditions of uncertainty about the situation is carried out under the following variants.

1) The probabilities of possible conditions of the situation are known. In this case a way of actions when the average value of the expected result is calculated, i.e. the sum of the products of the probabilities of the weather types to the corresponding results of the solution of the task is maximal has to be chosen.

2) The probabilities of possible conditions of the situation are unknown but there are considerations about their relative values. It is assumed that any of the conditions of the situation are no more probable than others. Then the probabilities of the various conditions of the situation can be taken equal.

3) The probabilities of possible conditions of the situation are unknown but there are principles and methods of approach to the evaluation of the result of actions that can be represented by the Wald, Savage, and Hurwitz criteria [9].

4 MATHEMATICAL MODEL FOR CALCULATING PROGNOSTIC ESTIMATES OF THE FAILURE OF TECHNICAL MEANS OF A FISHING VESSEL

Hydrometeorological conditions at sea are constantly changed when the fishing vessel operates at a fishing ground, i.e. the nature can be in the states $S_1, S_2, S_3, \dots, S_i$. Long-term statistics [8] shows that the probability of failure of the main engine or the steering device increases under conditions of the unfavorable weather. Since the probabilities of changing weather states do not depend on the time but depends only on the states of S_i , a uniform Markov' chain [9] can be considered here. The probability of the nature transition from the state of S_i to S_j is denoted by P_{ij} . Then the total transition probability can be given by the transition matrix:

$$P = \begin{pmatrix} P_{11} & P_{12} & \dots & P_{1n} \\ P_{21} & P_{22} & \dots & P_{2n} \\ P_{31} & P_{32} & \dots & P_{3n} \end{pmatrix} \quad (1)$$

Elements of the matrix satisfy to conditions:

$$0 \leq P_{ij} \leq 1; \quad \sum P_{ij} = 1 \quad (2)$$

where: $i, j = 1, 2, \dots$

The unconditional probability that the vessel will be in the state S_i at time T_m is denoted by $P_i(\tau)$. The conditions for the trip may be as follows: $S_1, S_2, S_3 \dots S_j$. This case the set of probabilities $P_i(\tau)$ forms a stochastic vector of the system state:

$$U_\tau = P_1(\tau), P_2(\tau), \dots, P_i(\tau); 0 \leq P_i \leq 1; \sum P_i(\tau) = 1 \quad (3)$$

The unconditional probabilities $P_i(\tau)$ for any value of m characterizing the state of the system S can be determined if the vector of initial states is known:

$$U(0) = P_1(0), P_2(0), \dots, P_i(0) \quad (4)$$

Using the formula of total probability it can be written:

$$U_j(1) = \sum P_i(0) \quad (5)$$

In the matrix form this expression can be represented as:

$$U(1) = U(0)P \quad (6)$$

For any τ :

$$U(\tau) = U(\tau - 1)P \quad (7)$$

The total probability of failure of the main engine during the state $U(\tau)$ of the system is calculated by the formula [9]:

$$V_i = \chi_i U(\tau) \quad (8)$$

where: χ_i = probability (frequency) of failure of the main engine, $i = 1, 2, \dots, \tau = 1, 2, \dots$

Let us consider the following conditions during the trip of the vessel as an example for its state assessment [4]: "good" weather conditions (wind of 1-5 points); weather conditions of medium "severity" (wind up to 7-8 points); "difficult" weather conditions (wind of 9-11 points). The probability (the vector) of the failure under the first weather conditions is 0.001, at the second - 0.002, at the third - 0.01. The transitional probabilities can be given as:

$$P = \begin{vmatrix} P_{11} = 0.5 & P_{12} = 0.3 & P_{13} = 0.2 \\ P_{21} = 0.3 & P_{22} = 0.3 & P_{23} = 0.4 \\ P_{31} = 0.2 & P_{32} = 0.2 & P_{33} = 0.3 \end{vmatrix} \quad (9)$$

using statistical data, past experience and expert estimates. It is required to obtain predictive estimates of the probabilistic state of the system in two, three, four, five periods (decades). Initially, the limiting probabilities of the state of the system are established for a sufficiently long period $\tau = 1, 2, 3, \dots n$. Then, the probabilities of failures of the main engine for different states are calculated. Calculations will be made using the formula for the total probability. The theory of Markov' processes is used to solve the problem. An ergodic Markov' chain is considered when any state S_i can be reached from any state S_j in a finite number of steps [9]. Using the transition matrix P (9) the vector of initial states is found as: $U(0) = 0.5; 0.3; 0.2$. The state of the system when $\tau = 1$ is described by the vector:

$$U(1) = U(0)P = [0.5 \ 0.3 \ 0.2] \begin{vmatrix} 0.5 & 0.3 & 0.2 \\ 0.3 & 0.3 & 0.4 \\ 0.2 & 0.5 & 0.3 \end{vmatrix} = [0.38 \ 0.34 \ 0.28] \quad (10)$$

The above probabilities define conditions of the trip. After two decades:

$$U(2) = U(1)P = [0.38 \ 0.34 \ 0.28] \begin{vmatrix} 0.5 & 0.3 & 0.2 \\ 0.3 & 0.3 & 0.4 \\ 0.2 & 0.5 & 0.3 \end{vmatrix} = [0.348 \ 0.356 \ 0.296] \quad (11)$$

The results of similar calculations after four decades are shown in Table 6-

Table 6: The state of the system when $\tau = 4$

| τ | 0 | 1 | 2 | 3 | 4 |
|-------------|------|------|-------|-------|-------|
| $U_1(\tau)$ | 0.50 | 0.38 | 0.348 | 0.340 | 0.338 |
| $U_2(\tau)$ | 0.30 | 0.34 | 0.356 | 0.359 | 0.360 |
| $U_3(\tau)$ | 0.20 | 0.28 | 0.296 | 0.301 | 0.302 |

Let us assume that the vector of initial states has a value that differs from the vector in the previous calculations: $U(0) = 0.6; 0.2; 0.2$. The results of similar calculations for $\tau = 5$ are shown in Table 7.

Table 7: The state of the system when $\tau = 5$

| τ | 0 | 1 | 2 | 3 | 4 | 5 |
|-------------|-----|------|-------|-------|-------|-------|
| $U_1(\tau)$ | 0.6 | 0.40 | 0.354 | 0.341 | 0.338 | 0.337 |
| $U_2(\tau)$ | 0.2 | 0.34 | 0.352 | 0.359 | 0.360 | 0.360 |
| $U_3(\tau)$ | 0.2 | 0.26 | 0.294 | 0.300 | 0.302 | 0.302 |

An analysis of the data in Tables 6 and 7 shows that real probabilities tend to $U_1(\tau) = 0.337$, $U_2(\tau) = 0.360$, $U_3(\tau) = 0.302$ when τ tend to ∞ . It can be concluded that for the given matrix of transition probabilities the limiting probabilities of the system states do not depend on the initial states. The total probability of the main engine failure for each period and the weather conditions V_i is calculated by the formula (8): $V_1 = 0.004$; $V_2 = 0.0031$; $V_3 = 0.0030$; $V_4 = 0.0031$. The most important is the probability of engine failures under a severe storm, which offers a real threat of emergencies and accidents.

5 CONCLUSIONS

- The increase of the intensity of navigation and the volume of sea freight traffic is associated with an increase in the likelihood of the accidents occurrence. The development of the industrial fishery activates the necessity of providing the fishing fleet safety during the trip to/at the fishing grounds.
- The scenario method is suggested to define “bottlenecks” when planning the trip of the fishing vessel to a fishing ground, to predict developing emergency situations, to identify tasks which necessary to solve for preacting them or reducing possible negative consequences.
- Mathematical model for calculating predictive assessments of the state of the “vessel-

nature” system and probabilities of technical means failures, in particular the main engine, can be used as an imitation model. It can give a possibility to study the dynamics of changes in the state of the system under different input variables, to choose rational management decisions, including solutions for the risk management.

REFERENCES

- [1] Kristiansen, S. Maritime transportation: Safety management and risk analysis. Elsevier, 2010
- [2] IMO. International Maritime Organization. MSC Circular 829: Interim Guidelines for the Application of Formal Safety Assessment. – London, IMO, 1997
- [3] FAO. Safety for fishermen. In: *FAO. Food and Agriculture Organization of the United Nations* [online]. Rome: FAO, 2018. [viewed date 11 May 2018]. Available from: <<http://www.fao.org/fishery/safety-for-fishermen/en/>>
- [4] Lambert, D. and Vasta, M. Risk assessments of fisheries to inform policy. In: *Proceedings 5th International Fishing Industry Safety & Health Conference*. [online]. Canada. St. John's, Memorial University of Newfoundland and Labrador, June 10–13, 2018. [viewed date 14 August 2018]. Available from: <<https://ifishconference.ca/>>
- [5] Allianz. Allianz Global Corporate & Specialty Safety and Shipping Review 2017. In: An annual review of trends and developments in shipping losses and safety. [online]. Munich: Allianz, 2017. [viewed date 09 April 2018]. Available from: <<https://www.agcs.allianz.com>>
- [6] EMSA. Analysis on marine casualties and incidents involving fishing vessels. In: European Maritime Safety Agency. [online]. Lisbon: EMSA, 2018. [viewed date 14 August 2018]. Available from: <<http://emsa.europa.eu/>>
- [7] SMRS. Analysis and state of accidents. In: State Marine River Supervision [online]. Moscow: SMRS, 2018. [viewed date 14 August 2018]. Available from: <<http://sea.rostransnadzor.ru/>>
- [8] Moiseenko, S. and Meyler, L. Risk management in navigation and the industrial fishery. Moscow: Morkniga, 2017 (in Russian)
- [9] Ventzel, E. Operations Research. Moscow: Knorus, 2013 (in Russian)

SECURITY ANALYSIS OF THE NATIONAL MARITIME TRANSPORTATION SYSTEM AS PART OF THE MARITIME CRITICAL INFRASTRUCTURES

**Flotilla admiral Boyan Mednikarov, Prof. DSc, Capt (N) Nedko Dimitrov, assoc.prof.
PhD and CDR Valentin Vasilev, assist. prof. PhD**

Nikola Vaptsarov Naval Academy
73, Vasil Drumev Str. 9026 Varna Bulgaria
e-mail: n.dimitrov@nvna.eu, web page: <http://www.naval-acad.bg>

Keywords: maritime transportation system, maritime critical infrastructure, security assessment, crises management.

Abstract. The authors analyze the Bulgarian legislation in the maritime security domain and the national maritime transportation system in order to determine the bodies and their functions in favor of the security of the shipping and to look for a way for improvement. When the complex system theory (system approach) is applied and the maritime transportation infrastructures are counted as a part of maritime critical infrastructures, the security analysis in the framework of the whole system will be spread over its part - the transportation system. When common standards for security environment are established the control of the security processes in the regional aspect and the crises management in the security domain will be easier and more effective.

Introduction

If we turn back to the history, we could obtain the information that the establishment and maintenance of the seaways and ports security was an important priority of coastal state authority such as in the ancient Greece (6th-4th centuries BC). For instance, a port fee was introduced as a kind of tax amounting up to 2% of goods on board because warships patrol the sea lanes, keeping safe merchants from pirate's raids. Normally, when the pirates intensify their invasions, the taxes have been raised temporarily even up to 10% [8]. Nowadays, globalization provoke intensification and sophistication of the transport connections. Moreover, maritime transportation system becomes more complex in structural aspect than ever. The paper 'National prospective for transport infrastructure development' adopted by Bulgarian Ministry of transportation' says that the "Safety and security of the transportation system" is set as paramount priority. The Sectoral Operational Program "Transport" has been developed due to need of enhancement the fundamental national sectoral policy. It delineates detailed way for implementation of the Strategy for development of transport infrastructure. The main objective is to materialize sustainable transport connections between all economic actors. The specific objectives define the framework for integration of the national transportation system into the EU transport network thus achieving a balance between wide spectrum transport subsystems. It gives noticeable indications that the government should be obligated to develop a sustainable transportation system.

The research problem identification

The IMO Concept of a sustainable maritime transportation system [7] determines its elements and the way to create favorable conditions to maintain the sustainable system state. This concept recognizes the international maritime transport system as a mechanism for global trade economic growth and sustainable development.

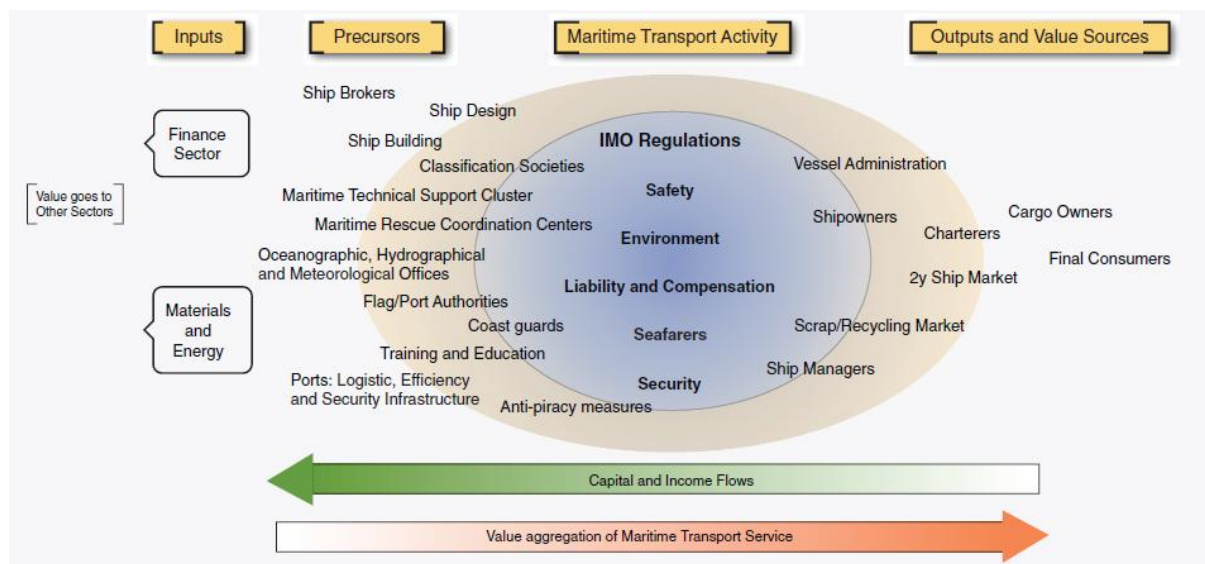

Fig.1 The maritime transport system [7]

One of the key elements of the ‘Maritime transport activity’ area is Security. The implementation of security here is based on IMO regulations [1].

The Bulgarian maritime transportation system is part of the international transportation system and includes components, connected with transport infrastructures, maritime business, regulatory legislation and bodies, service providers, owners, customers, educational bodies, logistic chains etc. It continues and connects the routes of other modes of transport - land and air. The preference of a particular type of transport for a given activity is determined by economic, tourist, geographic, temporal and other considerations, including the security (environment). The modern criterion of security is increasingly high. In a theoretical sense, the term "security" is associated with the "risk" and "protection" categories.

Bulgaria has adopted own national legislation on the subject synchronizing it with the relevant international one (IMO and EU level).

Nevertheless, it is called “system”, in fact only geopolitical, financial and investment aspects are concerned. The element physical security is replaced with the operational safety. But the security environment has to be controlled and improved.

Normally, the term “maritime security” is applicable to describe distinctive unique characteristics of maritime environment concerning the functional aspect of studied system. It is used in official documents by the International Maritime Organization and relates to the security of the maritime transportation system, port facilities and offshore infrastructure. It concerns a system’s resilience to withstand against transboundary aggression, terrorist activities and other deliberate destructive impacts. It could be defined as a combination of preventive measures aimed at protecting shipping and port facilities against threats related to illegal activities [1]. This definition is also quoted in the ISPS Code adopted on 12 December 2002 by Resolution 2 of the Conference of Contracting Governments to the International Convention for the Safety of Life at Sea, 1974, and in Regulation (EC) No 725/2004 of the European Parliament and of the Council of 31 March 2004 concerning the improvement of security of ships and port facilities [6]. Furthermore, there are discrepancies between

linguistic representation and the meaning of the term. More often than not it still is beyond comprehension to wide auditorium. For instance, in the official translation into Bulgarian of this Regulation, published on the Executive Agency Maritime Administration website, the term "maritime security" in the definition is replaced by "maritime safety". The analogous analysis of the term "maritime safety" links it to the protection of human life, the marine environment and property in the maritime environment from unintended direct or collateral impacts. It is defined in the above mentioned document as continuously maintaining and enhancing resilience of the system in terms of safety of navigation and protecting of human life, health, property and the marine environment in general. It includes:

- Safety of the ship, its crew, passengers and / or cargo carried.
- Navigational safety.
- Environmental safety, including crisis prevention and response measures such as protecting the sea against pollution caused by ships. It includes a possibility of enforcing sanctioning forbidden pollution and intervening of competent authorities in order to limit the harm caused by incidents.
- Responsibilities and compensation for damages caused by ships [5].

Tendentious or not, an incorrect definition is created. It directs efforts to ensure only the safety of the Maritime transportation preventing possible unintended impacts. In addition, the document creates confusion due to the use of the two terms, both safety and security, in the same context. The Strategy for Development of the Transport Infrastructure of the Republic of Bulgaria [10] carries out an analysis of the national infrastructure and outlines the directions for the development of the sector. It takes into account solely the impact of geopolitical and economic factors upon the transportation connections and elements of transportation system, presenting the objectives and priorities for development, the expected final results and the projects for their realization. In Chapter Three, entitled "Analysis of the strengths, weaknesses, opportunities for development and potential threats", it is revealed that there is "insufficient security in ports". It is figured out as a weak side of maritime transport, but no analysis has been made of the level of security, desirability of security and there are no mechanisms for enhancing the security of ports thus neglecting essential provisions of the ISPS Code.

In the National port development program, developed pursuant to Article 103a (2) of the Maritime Spaces Act, inland waterways and ports of the Republic of Bulgaria [2] it is only stated that the analysis of strengths and weaknesses, opportunities and threats (SWOT analysis) suggests "improving security and safety systems in ports" as an "opportunity". Actually, the notion of security does not appear in the "weaknesses" or "threats" sections. Only the organizational, technical, infrastructure and financial aspects related to economic and investment security are taken into account.

Based on the security situation of ports and other critical infrastructure concerning economic activities at sea, the program provides specialized proactive measures to increase maritime security and safety by implementation of:

- Assessment of port security by all competent governmental institutions.
- Improvement of the port control and security regime by means of audiovisual surveillance and control systems, electronic access control systems, barriers, fencings, permanent or removable enclosures and wide spectrum of measures that increase level of physical security. Responsible for the implementation of this group of measures are border control authorities.
- Synchronization of Bulgarian standards and norms for safety and security of ports with the international and European standards.
- Synchronization of Bulgarian standards and norms for environmental protection to international and European norms.

- Introducing an adapted management and control system to ensure healthy and safe working conditions.

Sustainability of the Transportation system is considered to be one of baseline requirements for resilience after The Warsaw Summit Resilience Commitment held in July 2016. Actually, it is made as a political link between defense, deterrence and resilience concerning safety and security of society related with the civil preparedness. The work on resilience is inspired from the Article 3 of the Washington Treaty stressing national obligations and contribution to the allied defense and deterrence.

Obviously, using system approach, it is necessary both elements and connections between prominent subsystems and elements to have specific characteristics enhancing resilience and cohesion of the National Maritime Transportation System. The system surrounded and influenced by maritime security environment requires timely and adequate management in order to withstand against unfavorable external impacts. It is vital to preserve its structure, purpose and delineated spatial and temporal boundaries.

Moreover, the resilience of the National Maritime Transportation System could be maintained efficiently by using NATO-EU Cooperation and focused national efforts. The national legislation framework provides needed basis for synchronization of wide spectrum activities originated by competent governmental institutions interacting with international organizations and foreign governments. Next, the building resilience process should be initiated at national level by implementing detailed analyzes and self-assessment. Last but not the least, education and training are other milestones marking the road ahead [11].

The reassessment over the last decade of energy policy and in particular the specific role of the state in the provision of energy services through energy market liberalization in the "energy sources and supply" sector, has been reflected in the Energy Strategy of Bulgaria. However, under term security of energy supply is meant to increase interdependence in the use of the country's key geographic location for increasing transit of Russian and Asian resources such as natural gas, oil and electricity to the west and south. Another point is the possibility of diversification of the energy sources and suppliers [9]. Similarly, the maritime infrastructure could be related to the production and transport of hazardous and dual-use goods and components such as chemical, biological, explosive, etc. Typically, users of this infrastructure meet safety standards and environmental requirements. However, the protection of these maritime critical infrastructures is not adequate to the potential threats and possible ways of their implementation from the sea. The relation between security and contemporary threats to maritime infrastructure and transportation system infrastructures it is not mentioned neither in the Operational Program "Regions for Growth 2014-2020" of the Ministry of Regional Development and Public Works [3], nor in the regional development plans of the districts of Varna and Burgas.

Security analysis of National maritime transportation infrastructure

The maritime transport infrastructure supports the maritime transport system and is the physical base to provide all the necessary services for the system functions. It consists of ports with their intermodal connections, seaways, ships and management systems. All those elements are recognized by Bulgarian national legislation as critical infrastructures¹. The security of the physical and the informational maritime transport infrastructures is fundamental for the system functions.

¹ There is officially issued (by the Council of Ministers decision) list of the national strategic objects and those that are recognised as critical infrastructures.

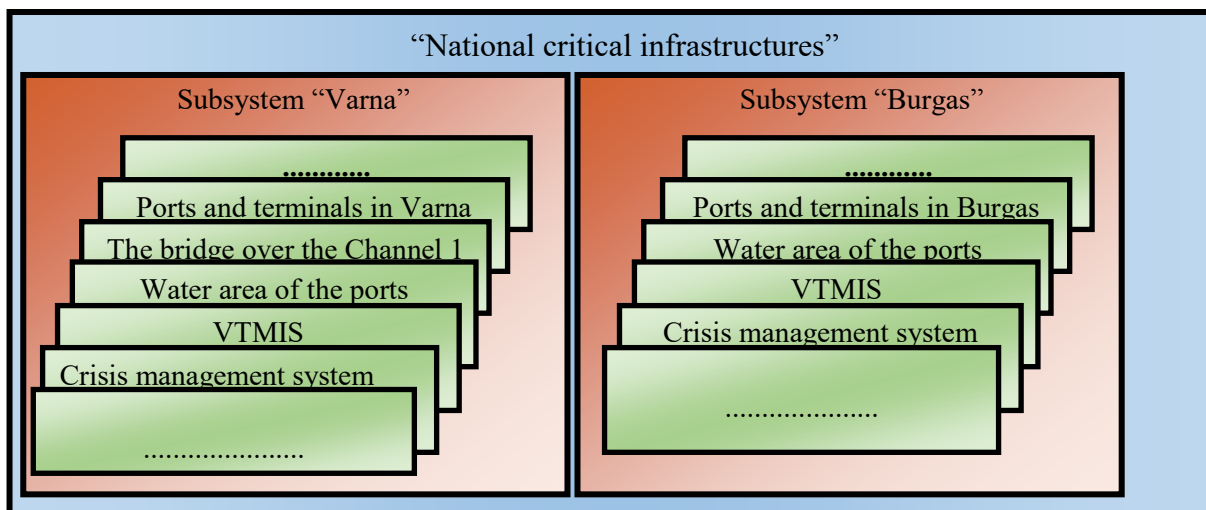

Fig.2 National critical infrastructure system

The analysis of the present security condition of the Maritime transportation system infrastructure elements (shown at fig.2 as part of the national critical information system) indicates that the protection of maritime shore infrastructure is organized only landward. Generally, it is built by modern facilities used to control access to objects, including incoming and outgoing traffic thus preventing unauthorized access. However, the security of transportation system elements, assets at sea and the adjacent infrastructure against threats raised seaward is established based on the assumption that there is a low possibility it to appear there. This way the possibility of unauthorized access from the sea side is not as risky as from the land side and the prevention is not so firmly organized. Another specific factor shaping security environment characteristics is, that there is a feeling that there is at national level a well-organized and working system, which has the capability to detect and counteract timely the deliberate security threats to the maritime transportation system elements originating from seaside.

Usable outcomes for the analysis could be drawn derived from the analysis of the conceptual security aspect of the maritime transportation infrastructures elements. On one hand, the establishment and management of modern national maritime transportation system that meets both national and European requirements is an important national priority. The Government is actively involved in this process, striving to harmonize national legislation with the norms of the European Union and creating favorable conditions for the development of the sector. Next, efforts of national level to ensure the security of the Maritime transportation system are fragmented to the responsible authorities and the operators of the infrastructure. Military authorities have got considerable scientific, analytical and technical potential, as well as network capabilities to operate in coalition environment, but to a certain extent they are not the national leader for the research, organization and protection activities.

On the other hand, researchers and developers of maritime safety regulations are handling a conceptual apparatus that does not provide a homogeneous understanding of categories, their scope and compliance on national and European level. So, introducing ship's or port facility's security plans, criterion of setting security levels, port security officer or security officer on board the ship, etc. is a progressive step towards creating a favorable environment for the functioning of National maritime transportation system's elements. These actions are result of

the necessity international security regulations and standards to be applied. Another illustrative outcome is that the actual security threats are not taken into account in the process of protection development. Analyzing the security of the maritime transportation infrastructures by departmental cross-section approach, the main focus is on resource management in order to achieve maximum financial efficiency under a vaguely defined security environment.

Possible applicable approach to address the described deficiencies is to consider the security of the maritime transportation system / infrastructures in the context of regional or local crisis management activities. The logic is based on the fact that security incidents occur having a local (geographically) character rather than a departmental realization. Threat detection, neutralization, incident response and recovery activities are performed locally, within the established organization on a national and regional scale, from the forces and resources of different competent governmental and non-governmental agencies and organizations. The management of these activities should be inter-institutional in structural aspect, local in spatial aspect, continuous, and sustainable in functional aspect in order to be effective.

Let us assume that the crisis management activities are designed so that to be applicable in a sense of the National transportation system and interpreting the implementation of general provisions of modern security paradigm. Because we divide the crisis management process generally on three phases (prevention, reaction and recovery), on the preventive actions phase all the activities of accurate risk prediction and precise risk analysis are implemented, followed by control of the technical parameters of the infrastructure security, education and training of the operating personnel as well as the critical services involved personnel and monitoring of the environment and subsequent early warning. Certifications and verifications are carried out intended to establish the quality, performance, and reliability of security plans and readiness to act when security incidents appear. Security plans are developed and coordinated during the planning stage and organizing the protection of the National maritime transportation infrastructures. Co-ordination takes place in both the governmental and regional institutional formats.

In general, prescribed standard procedures recommend to promulgate warnings through the current communication channels or through the existing common search and rescue system in the immediate response to a security incident. Mitigation of unfavorable environmental effects and emergency restoration procedures should be implemented during rescue operations with rendered assistance of specialized additional modules. Without a doubt, it is necessary the private sector to be involved sharing human resources, financial resources, assets and equipment. The quantity and quality of the planned activities during last two phases are selectively executed depending on the type and scope of the given crisis or security incident. Applying the system approach in order to analyze the security of social and economic systems including transport in the context of the crisis management system and applying uniform standards, procedures and tools is a guarantee for determining timely and adequate level of risk and defining commensurate activities at different levels by departments of agencies and organizations. It will overcome in considerable extent existing differences between agencies and organizations in their approaches concerning system analysis and risk assessment.

In this aspect it is appropriate to apply a comprehensive system approach for analyzes on a relevant scale - global, national, and regional. The objects of the transportation system as well as the other maritime infrastructure elements do not exist and operate separately and independently. They are permanently linked in functional, physical and informational way. Due to this inherent connectivity, security analyzes and assessments will be more impartial if it is taken into account all existing interrelationships and all measurable resulting outcomes. On this basis, the National maritime transportation infrastructures, in terms of infrastructure security, should be seen as part of the National Critical Infrastructure system because of the following:

- The transportation system is one of the critical infrastructure sectors, due to the severity of the potential cascading social and economic effects caused by potential security incident on each of the elements of the National maritime transportation system.
- The geographic, physical and information connectivity between critical infrastructure elements, regardless of the sectors to which they belong, determines the existence of connections with a certain strength that can be exploited in a framework given by potential security incident.
- All elements of particular regional subsystem of the National Critical Infrastructure, including transport, operate under identical security environment conditions typical for the region.

According to the definition, the security of the system is a dynamic balance between potential threats and active measures taken to protect system's elements. Thus, the balance means a normal system's state that has to be sustainable. In other words, the analysis of the system is carried out in order to study the criticality of the individual elements and to identify proper timely and adequate measures for their protection. The security analysis and the level of security of the transportation system infrastructure could not vary from the same for the other sectors of the national critical infrastructures.

The establishment and maintenance of a favorable security environment is not related to any changes of the national legal framework. It is recommended the Council of Ministers to adopt an uniform methodology for critical infrastructures risk assessment in the framework of the security crisis management process. The adoption of uniform standards for security assessment by applying the integrated approach, methodologically and expertly provided especially by the Bulgarian Army (Navy) together with Coast Guard and emergency services, would support the protection of National maritime transportation infrastructures. It will facilitate the selection process of adequate security level appropriate to the current environment during operation of critical infrastructure with its wide spectrum of sectors, relations and elements.

CONCLUSION

The maritime transportation system, in terms of infrastructure security, should be treated as part of the national critical infrastructure system. The security in the framework of the National Critical Infrastructure system is interpreted as a dynamic balance between potential threats and the protection measures against them. The analysis of the system is carried out in order to study the criticality of the individual elements and to identify measures for their protection. The departmental approach to performing asset security applied to the protection

of the marine transportation system infrastructures is not productive in current security environment.

The recommendation for creation and maintenance of a favorable security environment is a uniform methodology for assessing the risk of security crises management (based on the existing ordinance [4]) to be adopted. By applying the integrated approach, the adoption of uniform standards for security assessment, methodologically and expertly provided by the Bulgarian Army (Navy) together with Coast Guard and emergency services, will ensure the planning and achievement of an adequate level of security in the current environment for the maritime transportation infrastructures operation.

REFERENCES

- [1] Code of practice on security in ports, [viewed date 12 May 2018]. Available from: <http://www.imo.org>.
- [2] National Program for Development of Ports for Public Transport 2015, [viewed date 12 May 2018]. Available from: <http://www.strategy.bg/StrategicDocuments/View.aspx?lang=bg-BG&Id=469>.
- [3] Operational Program "Regions in Growth", [viewed date 12 May 2018]. Available from: <http://www.mrrb.government.bg>.
- [4] Ordinance of order, the method and competent authorities for the setting of critical infrastructures and their objects and assessment of the risk thereof, [viewed date 12 May 2018]. Available from: <https://www.lex.bg/laws/ldoc/2135816878>.
- [5] Ordinance on the conditions and procedures for achieving the security of ships, ports and port areas, [viewed date 12 May 2018]. Available from: <http://marad.bg/page.php?category=24&id=58&seek=%D0%B1%D1%80>.
- [6] Regulation (EC) No 725/2004 of the European parliament and of the Council of 31 march 2004 on enhancing ship and port facility security, Official Journal of the European Union, 29.4.2004, [viewed date 12 April 2018]. Available from: <http://eur-lex.europa.eu>.
- [7] A concept of a sustainable maritime transportation system, IMO, [viewed date 12 April 2018]. Available from: <http://www.imo.org/en/MediaCentre/HotTopics/SMD/Pages/default.aspx>.
- [8] Institut for marcet economic, [viewed date 12 April 2018]. Available from: <http://ime.bg/bg/articles/danycite-w-perioda-na-razcweta-na-antichna-gyrciq>.
- [9] The energy strategy of the Republic of Bulgaria till 2020, [viewed date 12 May 2018]. Available from: <https://www.me.government.bg/en/themes/the-energy-strategy-of-the-republic-of-bulgaria-till-2020-147-295.html>.
- [10] Strategy for Development of the Transport Infrastructure of the Republic of Bulgaria Until 2020, [viewed date 12 May 2018]. Available from: <https://www.mtirc.government.bg/en/>.
- [11] Joint declaration by the President of the European Council, the President of the European Commission, and the Secretary General of the North Atlantic Treaty Organization. 8 July 2016, [viewed date 12 May 2018]. Available from: http://www.nato.int/cps/en/natohq/official_texts_133163.htm.

ADVANCES IN THE SIMULATION OF SHIP NAVIGATION IN BRASH ICE

J. COLOM-COBB^{*}, B. SERVAN-CAMAS^{*}, J. GARCIA-ESPINOSA^{**†} AND E. OÑATE^{*}

^{*} Centre Internacional de Mètodes Numèrics en Enginyeria (CIMNE)
Gran Capitán s/n, 08034 Barcelona, Spain.
e-mail: jcolom@cimne.upc.edu, <https://www.cimne.com>

[†] Department of Nautical Science and Engineering
Barcelona School of Nautical Studies (FNB)
Universitat Politècnica de Catalunya – BarcelonaTech
Pla de Plau, 18, 08003 Barcelona, Spain

Keywords: Computational Fluid Dynamics, Semi-Lagrangian Particle Finite Element Method (SL-PFEM), Navigation in Brash Ice

Abstract. Brash ice is the accumulation of floating ice made up of blocks no larger than two meters across. Navigation in brash ice is becoming more usual as new navigation routes are being opened in the Arctic regions. This navigation brings new concerns regarding the interaction of ice blocks with the ship. Developments are presented towards the simulation of this navigation condition including the interaction among the ship and the ice blocks. This work presents the advances in the development of a computational tool able to simulate this problem, based on the coupling of a Semi-Lagrangian Particle Finite Element Method (SL-PFEM) with a multi rigid-body dynamics tool.

This work is part of the research project NICESHIP sponsored by the U.S. Office of Naval Research under Grant N62909-16-1-2236.

1 PROJECT OBJECTIVES

The project ‘Development of new Lagrangian computational methods for ice-ship interaction problems (NICE-SHIP)’ aims at developing a new generation of computational methods, based on the integration of innovative Lagrangian particle-based and finite element procedures for the analysis of the operation of a vessel in an iced sea, taking into account the different possible conditions of the ice. The computational analysis techniques to be developed in NICE-SHIP intends to improve the tools to evaluate the loads acting on the structure of a ship navigating in iced-seas and, in particular, to determine the ice resistance of the ship in different ice conditions.

This project is being developed at the International Center for Numerical Methods in Engineering (CIMNE, www.cimne.com) in Barcelona under NICOP Award N62909-16-1-2236 given by the U.S. Office of Naval Research.

The NICE-SHIP project has two main lines of research. The first one is oriented towards the modelling of the mechanics of ice [1,2,3,4,5,6], and the second one towards the simulation of navigation conditions in brash ice. In this work some details of the first line are presented, but the main focus will be on the second line.

2 MODELLING ICE MECHANICS

The constitutive structural model developed for ice first assumes an elasto-brittle material behavior of ice with a fixed yield function. The post-failure behavior of ice is modelled with a standard elasto-damage model. The model has been implemented in the context of the discrete element method (DEM). It is applied at each interface between two discrete elements (so far we have assumed spherical shapes in three-dimensional (3D) problems).

The model has been validated in the study of the multi-fracture situations of ice blocks under different loads using experimental results from the literature. The model has the necessary features to simulate the behavior of fast ice (sea ice which remain fast along the coast) and drift ice, including ice ridges (see Figures 1 and 2).

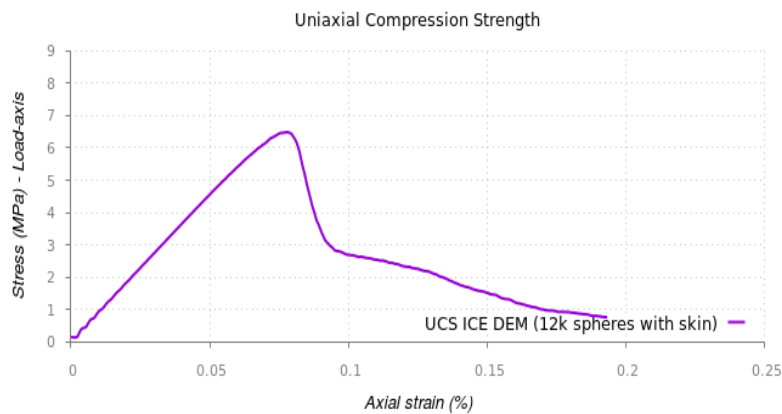

Figure 1: Axial stress-axial strain curve for a block of 7 MPa polycrystal ice under a uniaxial compression test. The straight blue line denotes the expected maximum stress Results obtained with the DEM using a mesh of 12000 spheres.

The constitutive model for ice has been tested in different scenarios that represent realistic operating situations of an ice-breaker. For this purpose, a contact algorithm has been implemented to handle ice-ship interaction. This algorithm can manage the contact between the ship and floating ice particles of sizes ranging from small particles (several decimeters, such as moderate ice blocks) and ice blocks of large size (see Figure 4).

3 NAVIGATION CONDITIONS IN BRASH ICE

3.1 Semi-Lagrangian Particle Finite Element Method (SL-PFEM)

The governing equations of the Navier Stokes equations for a Lagrangian particle are:

$$d_t \mathbf{U}_\lambda(t) = \mathbf{A}_\lambda(t) = \mathbf{a}(\mathbf{X}_\lambda(t), t) \quad (1)$$

$$d_t \mathbf{X}_\lambda(t) = \mathbf{U}_\lambda(t) = \mathbf{u}(\mathbf{X}_\lambda(t), t) \quad (2)$$

where t stands for time, d_t is the total derivative, λ is a Lagrangian particle label, $\mathbf{X}_\lambda(t)$ represents the position of particle λ at time t , $\mathbf{U}_\lambda(t)$ is the fluid velocity at $\mathbf{X}_\lambda(t)$ and time t , and $\mathbf{A}_\lambda(t)$ is the fluid acceleration at \mathbf{X}_λ and time t , $\mathbf{a}(\mathbf{x}, t)$ is the acceleration field at position \mathbf{x} and time t , and $\mathbf{u}(\mathbf{x}, t)$ is the velocity field at position \mathbf{x} and time t . In the SL-PFEM particles carry with them only the intrinsic material and flow properties. This allows the user to insert or remove particles without affecting the extrinsic flow properties (e.g., total mass).

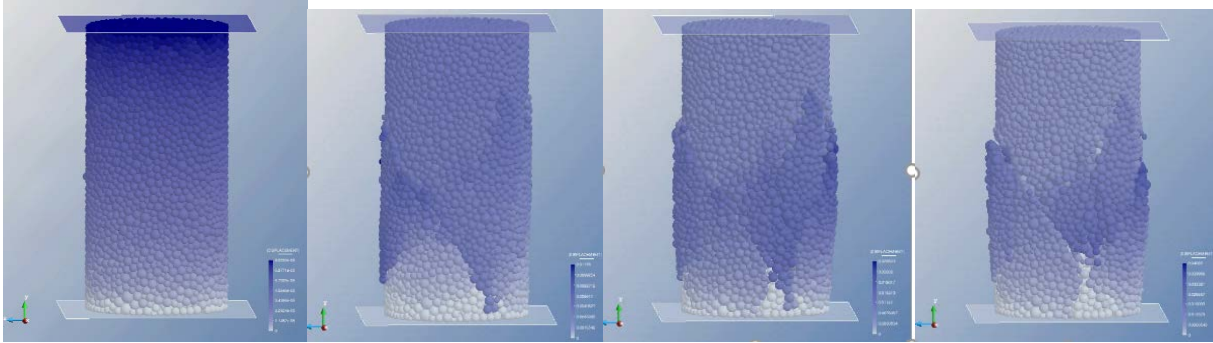

Figure 2: Snapshots of the deformation and failure of a block of 7 MPa polycrystal ice under a uniaxial compression test. Results obtained with the DEM using a mesh of 12000 spheres.

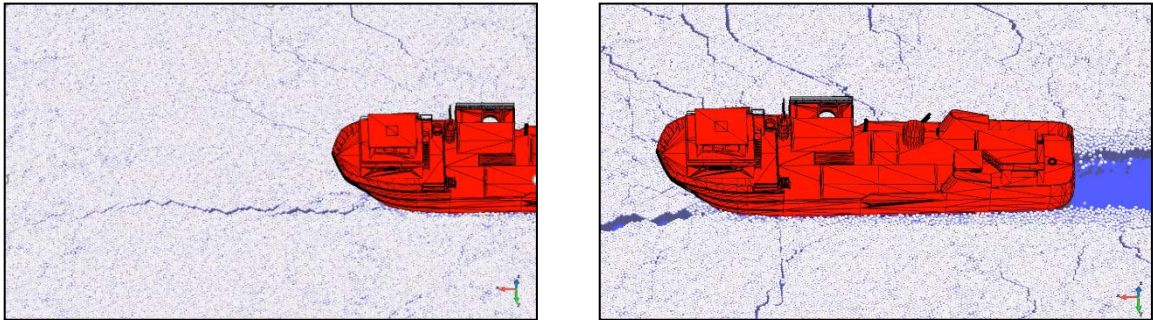

Figure 3: generic vessel. DEM results for ship-flat ice interaction analysis. Soft flat ice

When solving the incompressible Navier-Stokes equations the acceleration field is given by:

$$\mathbf{a}(\mathbf{x}, t) = -\nabla P(\mathbf{x}, t) + \nu \Delta \mathbf{u}(\mathbf{x}, t) + \mathbf{f}(\mathbf{x}, t) \quad (3)$$

where P is the fluid pressure divided by the fluid density, ν is the kinematic viscosity, and \mathbf{f} is the external acceleration field.

In a pure Lagrangian framework, one needs to estimate the right hand side of Eq. (3) based on the information contain at the particles. This task face a number of challenges and is computationally expensive due to the need of searching neighbouring particles in order to estimate the corresponding derivatives.

In this work, the right hand side of Eq. (3) is estimated using the finite element method on a background mesh. Then, the integration of Eq. (1) is carried out as follows:

$$\mathbf{U}_\lambda(t_2) = \mathbf{U}_\lambda(t_1) + \int_{t_1}^{t_2} \mathbf{A}_\lambda(t) dt \quad (4)$$

Eq. (4) can be split in tow equations as follows:

$$\mathbf{U}_\lambda^*(t_2) = \mathbf{U}_\lambda(t_1) \quad (5)$$

$$\mathbf{U}_\lambda(t_2) = \mathbf{U}_\lambda^*(t_2) + \int_{t_1}^{t_2} \mathbf{A}_\lambda(t) dt = \mathbf{U}_\lambda^*(t_2) + \int_{t_1}^{t_2} \mathbf{a}(\mathbf{X}_\lambda(t), t) dt \quad (6)$$

Eq. (5) represent a pure convection transport of momentum from position $\mathbf{X}_\lambda(t_1)$ to position $\mathbf{X}_\lambda(t_2)$. And Eq. (6) represent the increase of momentum due to the acceleration field. In order to solve Eq. (6) using the FEM on a background mesh, this must be mapped onto the FE mesh. Then a mapping operator \mathcal{M}^h is used to map a set of particles intrinsic dependent variables $\{\Psi_\lambda\}$ onto the FE mesh $\mathcal{M}^h(\{\Psi_\lambda(t)\}) = \psi_h(\mathbf{x}, t) = \sum_a N^a(\mathbf{x})\psi_a(t)$, where $N^a(\mathbf{x})$ are the usual FE linear shape functions, a is the mesh nodes index, are ψ_a are the corresponding nodal values.

In the SL-PFEM instead of solving Eq. (6), its Eulerian counterpart is solved, which is the following Stokes type equation:

$$\begin{aligned} \mathbf{u}_h(\mathbf{x}, t_2) &= \mathbf{u}_h^*(\mathbf{x}, t_2) + \int_{t_1}^{t_2} \mathbf{a}_h(\mathbf{x}, t) dt \\ &= \mathbf{u}_h^*(\mathbf{x}, t_2) + \int_{t_1}^{t_2} (-\nabla P_h(\mathbf{x}, t) + \nu \Delta \mathbf{u}_h(\mathbf{x}, t) + \mathbf{f}_h(\mathbf{x}, t)) dt \end{aligned} \quad (7)$$

Where

$$\mathbf{u}_h^*(\mathbf{x}, t) = \mathcal{M}^h(\{\mathbf{U}_\lambda^*(t)\}) = \sum_a N^a(\mathbf{x})\mathbf{u}_a^*(t) \quad (8)$$

$N^a(\mathbf{x})$ are the classic FE linear shape functions, and $\psi_h(\mathbf{x}, t) = \sum_a N^a(\mathbf{x})\psi_a(t)$ for any intrinsic dependent variable ψ . Once the velocity at t_2 is obtained solving Eq. (7), the velocity increase due to acceleration is interpolated and added to the particles

$$\mathbf{U}_\lambda(t_2) = \mathbf{U}_\lambda(t_1) + \mathbf{u}_h(\mathbf{X}_\lambda(t_2), t_2) - \mathbf{u}_h^*(\mathbf{X}_\lambda(t_2), t_2) \quad (9)$$

3.2 Modelling ice blocks as solid particles.

Figure 4 shows a typical condition of navigation in brash ice. In this condition, the interaction between the ship and the ice blocks results in an increased of the resistance to in still waters and in a risk of damage due to the interaction of the ice blocks with the hull and other parts such as the rudder and propellers.



Figure 4: Container ship navigating in brash ice.

In order to take advantage of the SL-PFEM framework, the ice block is proposed to be modelled by solid particles. The main idea is to use a sort of predictor-corrector scheme within each time step. First, solid particles are treated as fluid particles, leaving the ice block to evolve as a fluid volume. Once the fluid volume trajectory is obtained, the external forces acting on its boundaries can be predicted. Second, the rigid body movement of the ice block is calculated using the predicted external forces, and imposed on the solid particles.

Implementation steps

Step 1. Solid particles are left to behave as fluid particles. Then, the ice block will evolve as a fluid volume.

Step 2. The movement of the fluid volume can be split into three parts: translation, rotation, and deformation. The translational and rotational components are obtained by means of least squares, where it is minimized the squared error of the final position of the solid particles.

Step 3. Once the rigid body movements of the fluid volume are known, and using the integral form of the momentum equation for a fluid volume, the external forces acting on the fluid volume are predicted.

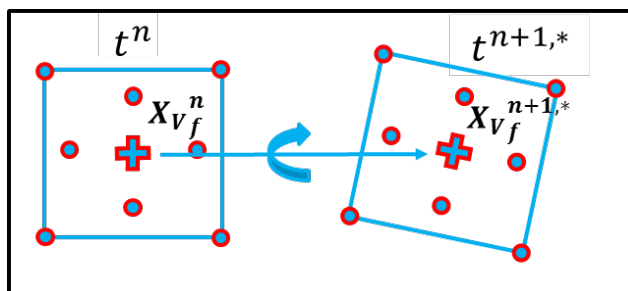

$$\mathbf{F}_e = \rho_f \frac{D}{Dt} \int_{V_f} \mathbf{u} dv = \rho_f V_f \frac{D\mathbf{U}_{V_f}}{Dt}$$

Step 4. Given the external forces on the ice block, its translation and rotation are obtained using the rigid body dynamics equations.

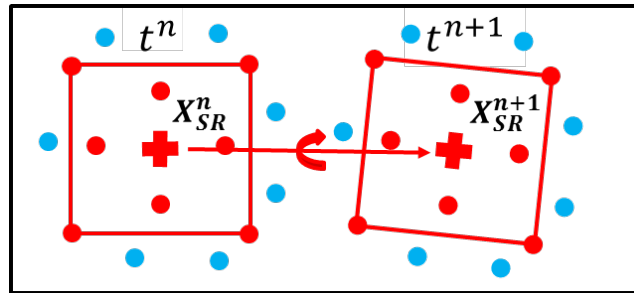

$$M_{SR} \frac{DU_{SR}}{Dt} = F_e \Rightarrow \frac{DU_{SR}}{Dt} = \frac{F_e}{M_{SR}} \Rightarrow \frac{DX_{SR}}{Dt} = U_{SR}$$

Step 5. Solid particles trajectories and velocities are imposed using the ice block translational and rotational movements.

3.1.1 Proof of concept.

The 2D flow around a circular cylinder is used as a proof of concept for the use of solid particles to model a rigid body. In this case, the cylinder moves forward with a constant velocity, so that solid particles are also enforced to move forward. Figure 2 compares the pressure field obtained using solid particles, and by imposing the body boundary conditions.

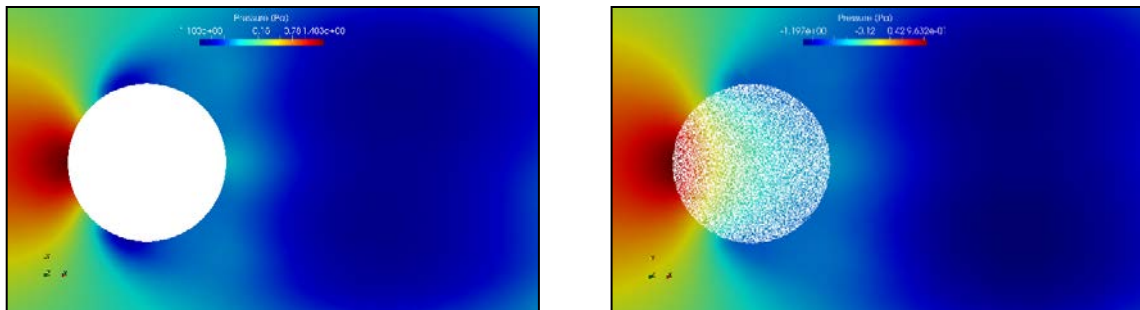

Figure 5: Pressure results for the flow around a cylinder by (Top) imposing body boundary condition and (bottom) using solid particles (solid particles are visible).

3.3 Simulating two ice blocks using solid particles.

After proving that this approach is valid when using proper mesh sizes, a simple proof of concept is proposed where two blocks of ice (one cylindrical and one polygonal) are left to move about freely in an incoming flow. See figure 3.

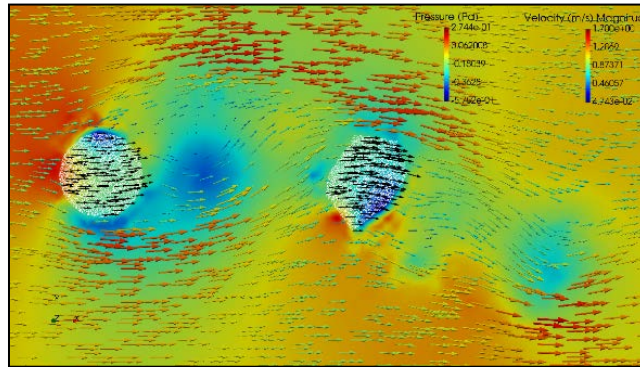

Figure 6: Simulation of two ice blocks. Pressure field over the mesh, velocity field over the fluid particles, and rigid body velocities over the solid particles.

3.4 Ice block interface enrichment (current work).

Certain problems can appear when small ice blocks are not properly defined at mesh-level. To alleviate this problem, a new method is being implemented that will better approximate this interface. This new implementation is based on an enrichment method [7] [8] where new degrees of freedom are added at mesh elements where an interface between an ice block and fluid appears. These new degrees of freedom allow to better capture the interface between the ice blocks and the fluid that surrounds it.

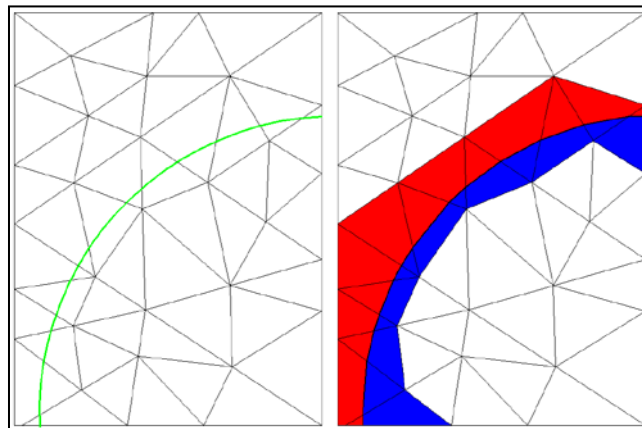

Figure 7: (left) Ice block interface over the mesh, (right) resulting enriched finite elements at the interface of the ice block.

3.5 Simulation of large number of ice blocks movements.

Different approaches on how to compute the interface of the ice-block with the fluid have been explained. This allows to compute with good precision how the fluid behaves around these ice-blocks and the forces that it applies to said blocks. But this is a two way problem and the

movement of the aforementioned ice-blocks must be computed so that a correct estimation of the whole problem is obtained.

Ice-blocks will be simulated as rigid objects that are moved using rigid body dynamics. In fact, not only movements have to be taken into account, but also the possible interaction/collisions between the different objects (Not only the ice-blocks but also the ship's hull). To simplify the implementation, an external library known as "Open Dynamics Engine" or "ODE" is used [9]. This library contains two main packages: A rigid body dynamics simulation engine and a collision detection engine.

Simple example

A first approach to the rigid body dynamics library was to analyse the efficiency when analyzing a certain amount ice-blocks without taking into account the fluid-flow time. This initial problem consists of 2000 ice-blocks formed by different geometries and uniformly distributed. Throughout the simulation a ship hull geometry crosses this layer of ice-blocks provoking movements and, especially, collisions between them. Table 1 and

Table 2 provide the details of the computation and the CPU times when using a regular desktop computer. Figure 10 shows some snapshots at different simulations times.

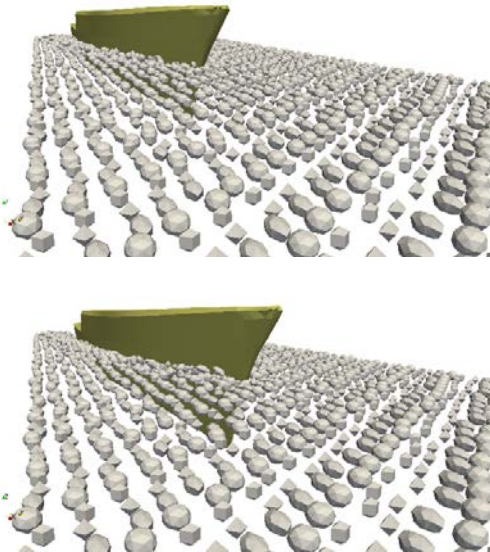

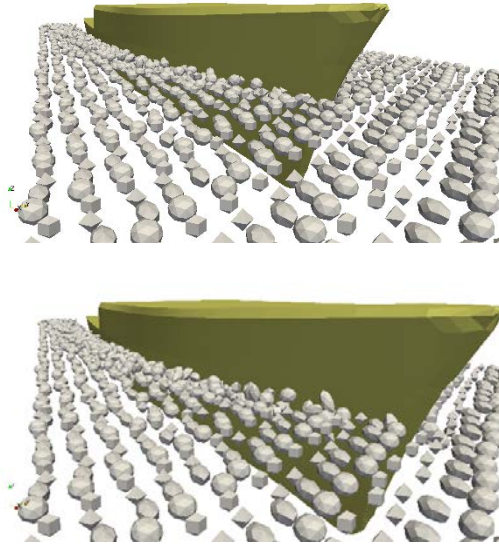

Figure 8: Snapshots a different simulation times

4 CONCLUSIONS

Using solid particles has the advantage that the ice blocks are approximated by fluid volumes, avoiding the problem of finding its boundary and imposing the corresponding boundary conditions. But the main problem with this method is that a good enough mesh is needed to properly define small ice blocks. When the ice block is not properly reproduced at mesh-level, problems at the interface can appear and therefore give poor pressure results. One way to alleviate this problem is to enrich the mesh at the interface with additional degrees of freedom and better define said interface of the ice blocks.

Table 1: Simulation particulars

| Problem Data | |
|-----------------------------|---------------------|
| Ship Mesh | 30K Nodes |
| Ice-Block Meshes | Avg. 30 Nodes/Block |
| Number of Ice-Blocks | 2000 blocks |
| Time-Step | 0.01 seconds |
| Total Simulation | 30 seconds |

Table 2: CPU time

| | | Time (seconds) |
|----------------------------|---------------------------|----------------|
| Mesh Read | | 0.44 |
| Generate Ice-Blocks | | 0.60 |
| Simulation Loop | Compute Collisions | 177.77 |

| | | |
|----------------------|----------------------------------------|--------|
| | Rigid Body Dynamic loop | 28.59 |
| | Output | 278.55 |
| | Total Simulation loop | 492.89 |
| Total Problem | | 493.92 |

In order to simulate a large number of ice blocks, an efficient solid dynamic solver with capabilities of simulating interactions between bodies is a must. The ODE library have shown to provide those capabilities while keeping a negligible computational time when compare to CFD times.

The combination of the ODE library with the modelling of the fluid flow around ice block using the SL-PFEM will provide a tool capable of simulating the increase of resistance in brash ice, as well as identify possible harmful interactions between the ice and the vessel.

4 ACKNOWLEDGEMENTS

This work is part of the research project NICE-SHIP sponsored by the U.S. Office of Naval Research under Grant N62909-16-1-2236. This support is greatly acknowledged.

The authors also want to acknowledge Miguel Angel Celigueta and Salvador Latorre, who are responsible of the development of the ice-mechanics model, presented in the corresponding section of this paper.

REFERENCES

- [1] Kelly S. Carney, David J. Benson, Paul DuBois, Ryan Lee , A phenomenological high strain rate model with failure for ice. *International Journal of Solids and Structures* 43 (2006) 7820–7839
- [2] Trisha Sain , R. Narasimhan, Constitutive modeling of ice in the high strain rate regime. *International Journal of Solids and Structures* 48 (2011) 817–827
- [3] A Combescure , Y. Chuzel-Marmot , J. Fabis, Experimental study of high-velocity impact and fracture of ice, *International Journal of Solids and Structures* 48 (2011) 2779–2790
- [4] M. Shazly, V. Prakash, B. A. Lerch. High strain-rate behavior of ice under uniaxial compression. *International Journal of Solids and Structures* 46 (2009) 1499–1515
- [5] H. L. Schreyer,¹ D. L. Sulsky,² L. B. Munday,¹ M. D. Coon,³ and R. Kwok. Elastic-decohesive constitutive model for sea ice. *Journal of Geophysical Research*, Vol. 111, C11S26, doi:10.1029/2005JC003334, 2006

- [6] J Heinonen, Constitutive modelling of ice rubble in first year ridge keel, Doctor of Technology Dissertation. Univ of Helsinki, 2004
- [7] Idelsohn, S.R., Oñate, E. Marti, J. and Limache, A. Unified Lagrangian formulation for elastic solids and incompressible fluids: Application to fluid–structure interaction problems via the PFEM *Comp. Meth. App. Mech. and Eng.* 197, 1762–1776 (2008).
- [8] Becker, P. A. (2015). An enhanced Particle Finite Element Method with special emphasis on landslides and debris flows. Ph.D. Thesis, Univ. Politècnica de Catalunya, Barcelona, Spain.
- [9] Open Dynamics Engine (ODE), <http://www.ode.org/ode.html>

AN OPTIMIZATION OF MARINE DIESEL ENGINE OPERATION PARAMETERS WHEN USING A MIXED FUEL (DO AND PALM OIL) AS ALTERNATIVE FUEL

Prof. DSc. Dang Van Uy^{*}, Prof. Dr. Nguyen Dai An[†] and MSc. Nguyen Duc Hanh[†]

^{*} [†] Vietnam Maritime University
No. 484 Lach Tray street, Hai Phong city, Viet Nam
e-mail: vanuydang@gmail.com, web page: <http://www.vimaru.edu.vn>

Keywords: Mixed fuel, Optimization of operating parameters, Adjustment of fuel supply system

Abstract. The purpose of this article is to introduce a optimization method to reset technical parameters of fuel supply system in order to allow marine diesel engines to use mixed fuels (vegetable oils & DO) to match required exhaust gas emissions and engines' performance without any problems.

1 INTRODUCTION

At present time, a tendency of using alternative fuels such as mixed fuels (vegetable oils and DO) for diesel engines in general and for marine diesel engines particularly is very common worldwide. Because, the mixed fuels have potential ability to reduce emissions in exhaust gas of diesel engines and be dependent from the fossil fuel in the future. The results of many researchs showed that diesel engines using mixed fuels can decrease a content of not only NO_x and also SO_x in exhaust gas.

However, when the mixed fuel (DO & Vegetable oil) used to substitute the conventional fuel for diesel engines may influence negatively on the fuel combustion inside cylinders, then consequently on their performance. Firstly, the different physical features and chemical structure of mixed fuels can make worse fuel combustion in marine diesel engines. Secondly, the different properties of mixed fuels can influence on the engines' injection timing and consequently on their exhaust gas emissions and fuel consumption. So, in order to use mixed fuels without any problem, an adjustment (re-setting) of fuel supply system of marine diesel engines must be taken into consideration. Therefore in this paper, authors will introduce a method to optimize technical parameters of fuel supply system of marine diesel engines using mixed fuels in order to match required exhaust gas emission limitations and performance.

2 THEORETICAL METHODOLOGY APPLIED FOR INVESTIGATION

The research is conducted into stages as follows: Firstly, there have to evaluate influences of a mixed fuel on operation parameters of a diesel engine such as fuel combustion inside cylinders, exhaust emissions and performance in comparison with that of the same diesel engine when using conventional fuel set by the engine maker previously; Then, results

obtained by calculation or simulation should be analyzed carefully in order to predict main factors and tendency that impact on operation parameters of a diesel engine; Finally, on a base of analysis results, there can use suitable optimization tool to do new settings for the engine to meet the required goals.

As well known, the changes of mixed fuels' properties associated with differences in chemical structure in comparison with conventional fuel will impact on the engine injection timing. The properties that will make main affects on the fuel injection timing are the speed of sound, the isentropic bulk modulus and the fuel viscosity. Furthermore, the ignition delay also is significant factor that can make changes of characteristic of combustion pressure inside diesel engine cylinders and the properties of fuel also are reasons to make changes of the ignition delay of diesel engines. Since the ignition characteristics of a fuel affect the ignition delay, this property of fuel is very important in determining diesel engine operating characteristics such as a fuel conversion efficiency, misfire, smoke emissions and so on.

In order to implement the investigation, mathematical formulas and simulation models are applied as following [1]:

- The impact of sound speed on fuel injection timing can be estimated for fuel supplied system by using the speed of sounds of diesel oil and a mixed fuel by following formula:

$$K = c^2 \rho \quad (1)$$

Where K is the isentropic bulk modulus [Pa], c is the speed of sound of a liquid [m/s] and ρ is density of a liquid [kg/m³].

- The impact of the isentropic bulk modulus can be calculated by a well-known model for fuel compression as following:

$$\varphi_{inj} = \frac{(p_{inj} - p_0) V_f}{K v_\varphi A_p} \quad (2)$$

Where: φ_{inj} - a crankshaft rotation required to reach a nozzle open pressure [⁰CA]; p_{inj} - nozzle open pressure [Pa]; p_0 - initial system pressure [Pa]; V_f -volume of compressed fuel [m³]; K - isentropic bulk modulus [Pa]; v_φ - speed of plunger [m/s]; A_p - area of plunger [m²].

- Correlation for ignition delay in diesel engines

There are many correlations that have been developed for predicting ignition delay, but the formula proposed by Hardenberg and Hase is choosen and expressed as [5]

$$\tau_{id}(CA) = \left(0.36 + 22\bar{S}_p\right) \exp \left[E_A \left(\frac{1}{\tilde{R}T} - \frac{1}{17,190} \right) \left(\frac{21.2}{p-12.4} \right)^{0.63} \right] \quad (3)$$

Where: \bar{S}_p - the mean piston speed [m/s]; \tilde{R} - the universal gas constant (8.3143J/mol.K); E_A - the apparent activation energy [J/mole].

- Fuel spray atomization and droplet size

To express fuel droplet size is very complicated, so the concept of the Sauter mean diameter (SMD) is applied and an empirical expression for the Sauter mean diameter DSM for diesel fuel properties proposed by Hiroyasu and Kadota is [5]

$$D_{SM} = A(\Delta p)^{-0.135} \rho_a g_f^{0.131} \quad (4)$$

Where Δp - mean pressure drop across a nozzle [MPa]; ρ_a - air density [kg/m³]; g_f - amount of fuel delivered per cycle per cylinder [mm³/cycle]; A- constant which equals 23.9 for hole nozzle, 25.1 for pintle nozzles.

- Optimization method

A meaning of optimization of working parameters of diesel engines is concerning with minimizing exhaust gas emissions, specific fuel consumption and good performance of diesel engines. The response surface methodology will be applied and mathematical model can be expressed [3]:

$$y = f(x_1, x_2, x_3, \dots, x_n) \pm \varepsilon \quad (5)$$

Where y is dependent variable, f is response function, x_i are dependent variables and ε is the fitting error. The goal of response surface methodology is to rapidly and efficiently reach the vicinity of the optimum. Therefore, the first order-model will be appropriate to solve the requested problems. To use response surface methodology as an optimization technique, a mathematical model of goal must be defined in form of an objective function. In this case, to optimize exhaust gas emissions and fuel consumption of a marine diesel engine using a mixed fuel, an objective function will be applied as follow [4]:

$$f(x) = Merit = \frac{1000}{\left(\frac{NO_x}{NO_{x,g}}\right)^2 + \left(\frac{g_e}{g_{e,g}}\right)} \quad (6)$$

NO_x – measured emission level; g_e - fuel consumption; $NO_{x,g}$ - goal emission level; $g_{e,g}$ - goal fuel consumption.

3 INVESTIGATION RESULTS

An experiment, then has been carried out on Hansin marine diesel engine 6LU32 equipped at Lab of Faculty of Marine Engineering (Vietnam Maritime University). The marine diesel engine with an output of 900kW at speed of 340rpm is driving a hydraulic brake. The Lab also is equipped with modern measuring instruments supplied by well-known company AVL (Austria). The mixed fuel that is selected for the investigation is a fuel produced by mixing diesel oil (DO) with pure palm oil with different ratio from 5% to 30%.

3.1 Arrangement of testing equipment

The equipment used to carry out experiment and their arrangement are showed in Fig.1.

In the research, an alternative fuel is a mixed fuel (or blended fuel) between diesel oil (DO) and pure palm oil in different volume ratio [%] and chemio-physical properties are showed in Table 1[6].

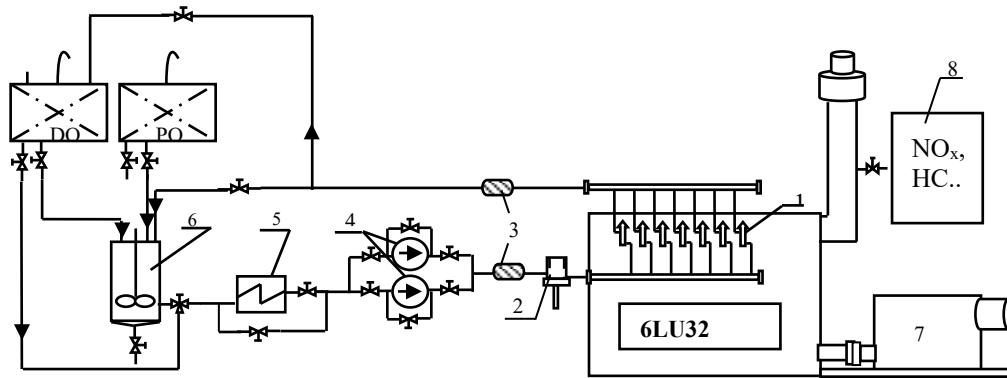

1 - High pressure pump; 2 -Final filter ; 3 - Flowmeter; 4 - Transferring pump mixer;
5 -Heater; 6 - Fuel continuous; 7 -Hydraulic brake; 8 - Gas analyzer (emissions)

Figure 1: Arrangement of testing equipment

Table 1: Fuel features of blended palm oil

| No | Fuel characteristic | Blended fuels and DO | | | | |
|----|----------------------------------------|----------------------|--------|--------|--------|--------|
| | | DO | PO10 | PO20 | PO30 | PO100 |
| 1 | Density at 15°C, [kg/dm ³] | 0.8464 | 0.8538 | 0.8599 | 0.8668 | 0.9225 |
| 2 | Viscosity at 40°C, [cSt] | 2.6 | 3.42 | 5.31 | 6.45 | 40.24 |
| 3 | Cetane number | 42.89 | 50.13 | 50.91 | 52.11 | 52.92 |
| 4 | LHValue, [MJ/kg] | 44.978 | 43.650 | 42.960 | 42.29 | 40.11 |

3.2 Evaluation of fuel properties impact on fuel supply system

The impact of fuel properties on injection timing and fuel combustion of diesel engines is very different and complicated. Therefore, first stage should be taken into consideration before implementing an optimization of the engine operation parameters is theoretical evaluation of fuel properties influence on the fuel supply system. Results of such evaluation will support so much the optimization process by decreasing a number of the optimization stages and the control factors.

Table 2: Results of fuel properties impact

| Fuel properties | Kind of fuel | | Difference [°CA] |
|-----------------|--------------------------------------------------|--------------------------------------------------|---------------------|
| | DO | Mixed fuel | |
| Speed of sound | 1.808 ⁰ CA;(8.876.10 ⁻⁴ s) | 1.759 ⁰ CA;(8.634.10 ⁻⁴ s) | 0.05 |
| Bulk modulus | 3.63 ⁰ CA | 3.33 ⁰ CA | 0.3 |
| Size of droplet | 31.17µm | 31.31µm | 0.14µm (0,5%) |

Then, the impact of the sound speed and of the bulk modulus of the mixed fuel estimated by using formula /1/ and /2/ is expressed in Table 3. For the calculation, the speed of sound should be taken in working conditions with temperature at 40⁰C and pressure at 18MPa and c₁=1430.68m/s for diesel oil No2, c₂= 1470.83 for mixed fuel (the speed of sound for mixed fuel is an average value that is asumed on a base of speed of mixed fuel with different ratio of palm oil from 5% to 25%). The length of high pressure tube from high pressure pump to

nozzle is equal to 1.270m and revolution is 340rpm (marine diesel engine 6LU32). The analysis of fuel droplet size has also been realized and results of the analysis is expressed in Table 2.

Regarding to fuel ignition delay, on a base of formula /3/, the calculation results for different ratio of palm oil in the mixed fuels are showed in table 3 [6,7].

Table 3: Calculated ignition delay of mixed fuels

| Ignition delay in [$^{\circ}CA$] | Blended fuels | | | | | |
|------------------------------------|---------------|--------|--------|--------|--------|--------|
| | DO | PO5 | PO10 | PO15 | PO20 | PO100 |
| | 2,1978 | 2,2049 | 2,2127 | 2,2158 | 2,2181 | 2,3003 |
| Increasing [$^{\circ}CA$] và [%] | - | 0,007 | 0,0140 | 0,018 | 0,020 | 0,101 |
| in comparison with DO | - | 0,30 | 0,60 | 0,80 | 0,910 | 4,595 |

So, on a base of the results of analytical analysis, there can assume that: The sound speed and isentropic bulk modulus of the mixed fuel make the start of fuel injection (SOI) earlier $0.05^{\circ}CA$ and $0.3^{\circ}CA$ respectively in comparison with diesel oil; otherwise, the activation energy (Cetane number) of the mixed fuel also increases fuel ignition delay by average $0.018^{\circ}CA$; The droplet size of the mixed fuel is increased not so much, only by 0,5%, but it can impact on fuel combustion process rather significantly [5]; Except the mentioned factors, there are many other factors can impact on the injection timing and fuel ignition delay, so there can take injection timing advance of approximately $1^{\circ}CA$ for further investigation.

Actually, the investigation results are only orientating and in practice, the impact of the mixed fuel properties is very complex. However, the results can open an right way for further research of optimization of the diesel engine operation parameters in next sections.

3.3 Optimization of operation parameters of diesel engine

The experiment was carried out on the marine diesel engine 6LU32 after getting the assessment results by calculation of the mixed fuel properties influence on injection timing and fuel droplet size distribution. Before implementing the experiment, a domain of investigation has been set as follows: Experiment should be carried out only on the engine load range around 80% of the nominal load; Exhaust gas emission should be focused on NO_x that is strictly required by IMO (Annex VI, MARPOL73/78).

Table 4: Factor variables

| Variables | Symbols | Levels | | |
|-----------------------------------------|---------|------------|------------------|-----------|
| | | Lower (-1) | Center point (0) | Upper (1) |
| Start of injection [$^{\circ}CA$ BTDC] | A | 10.5 | 12 | 14.5 |
| Injection pressure [MPa] | B | 17 | 18 | 19 |
| Ratio of Palm oil [%] | C | 10 | 15 | 20 |

The control factors are start of injection (SOI), injection pressure (IP) and ratio of palm oil in the mixed fuel (PO). The start of injection was chosen as SOI value after correction, the injection pressure was chosen as original value designed by the engine manufacture (18MPa) and ratio of PO are 10%, 20% and 30% and all the control factors are considered as center

points. So, the control factors can be seen in the Table 4.

Following up with the procedure of the development of experiment method using the RSM, the experiment was impemented on the center points and in accordance with the experiment matrix as presented in Table 5 and all the factor variables have been coded.

Table 5: Experiment design matrix

| No | X ₀ | X ₁ | X ₂ | X ₃ | Y ₁ | Y ₂ |
|----|----------------|----------------|----------------|----------------|----------------|----------------|
| 1 | 1 | 1 | 1 | 1 | 223.5 | 15.3 |
| 2 | 1 | 1 | 1 | -1 | 219 | 15.6 |
| 3 | 1 | 1 | -1 | 1 | 222.5 | 15.2 |
| 4 | 1 | 1 | -1 | -1 | 221.4 | 15.7 |
| 5 | 1 | -1 | 1 | 1 | 221.5 | 16.1 |
| 6 | 1 | -1 | 1 | -1 | 222 | 16.5 |
| 7 | 1 | -1 | -1 | 1 | 224.2 | 16.4 |
| 8 | 1 | -1 | -1 | -1 | 222.6 | 16.8 |
| 9 | 0 | 0 | 0 | 0 | 221g/kWh | 16.1g/kWh |

On a base of table 5, the regression models for the fuel consumption estimation (Y₁) and NO_x emission (Y₂) are established as follows:

$$Y_1 = 222.08 - 0.487X_1 + 0.587X_2 + 0.712X_3 \quad (8)$$

$$Y_2 = 15.95 - 0.5X_1 - 0.075X_2 - 0.2X_3 \quad (9)$$

The above regression models are very usefull to analyse which factor variable is most significant influence on the fuel consumption and NO_x emission of the diesel engine. To do so, ANOVA is used to analyse and give results that (Fig.2):

- The factor PO% most influences on the specific fuel consumption g_e, then the injection pressure and the start of injection factor (SOI);
- The factor SOI has most important role to change the NO_x emission, then the injection pressure and the factor PO% play least role.

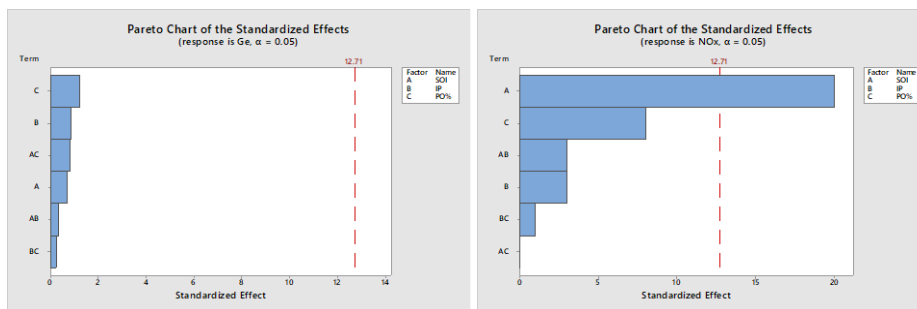

Figure 2: Pareto chart standardized effect on g_e, NO_x

So there can see that the ratio of palm oil in the mixed fuel has biggest impact on the fuel consumption, then the injection pressure. In case of NO_x emission, the start of injection is main factor, then the ration of palm oil.

To check the validity of the fitted models, the residual analysis is also conducted by using

Minitab software 18 and the results are presented at Fig. 3.

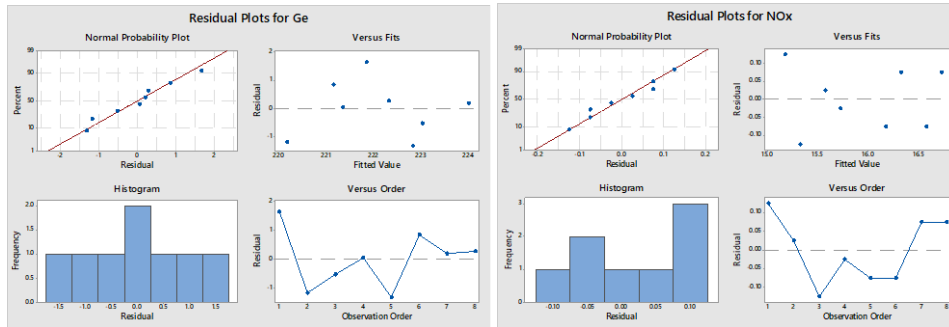

Figure 3: Four-in-One residual plots for g_e and NO_x

Based on these analyses, then the factor variable can be adjusted in accordance with the rule of the fractional factorials and the steepest descent method of optimization. Because, the use of fractional factorials is a most effective technique to minimize the number of observations and still achieves desired objective. Selection of a moving step for the control factors: based on the basic control factors and the regression equations, a moving step δ_i can be calculated and the results are showed in table 6.

Table 6: Control factors for fractional factorial experiment

| Levels | Control factors | | |
|------------------------------|------------------------------------|-------------------|--------------------------|
| | X_1 SOI [$^{\circ}$ CA BTDC] | X_2 IP [MPa] | X_3 Ratio of PO [%] |
| Center point | 12 | 18 | 15 |
| Changing step [Δ_i] | 2.5 | 1 | 5 |
| Coefficients | -0.48 and -0.5 | 0.58 & 0.075 | 0.712&-0.2 |
| $b_i\Delta_i$ | -1.25 | 0.58 | 3.56 |
| Moving step | -0.877 | 0.407 | 2.5 |
| Full number | -1.0 | 0.5 | 2.5 |

- Results of experiment

The experiment, then has been implemented by using the moving steps mentioned in table 6 and the objective function (8) was used to evaluate an optimization through the remit levels. The experiment results are presented in table 7.

Table 7: Results of optimization research

| No | X_1 SOI [$^{\circ}$ CA] | X_2 IP [MPa] | X_3 Ra. of PO [%] | Y_1 g_e [g/kWh] | Y_2 NO_x [g/kWh] | Remit |
|------------|-------------------------------|-------------------|------------------------|------------------------|-------------------------|---------------|
| Cen. point | 12 | 18 | 15 | 221 | 16.1 | 427.42 |
| 2 | 11 | 18.5 | 17.5 | 220 | 16.0 | 431.24 |
| 3 | 10 | 19 | 20 | 218.5 | 14.8 | 469.86 |
| 4 | 9 | 19.5 | 22.5 | 219 | 14.1 | 492.58 |
| 5 | 8 | 20 | 25 | 221 | 14.3 | 483.58 |
| 6 | 7 | 20.5 | 30 | 225 | 15.9 | 429.75 |

The NO_x limitation required by International Maritime Organization is expressed in Chapter VI, MARPOL 73/78 that can be calculated as function of the engine revolution. So, marine diesel engine 6LU32 with the nominal operation speed of 340rpm, the NO_x limitation is equal to 14.19g/kWh and then, the goal limitation emission NO_{x,g} = 14.19g/kWh . Meanwhile, the goal fuel specific consumption of this engine g_{e.g} = 210g/kWh.

Through the results of remit, there can confirm that the combination (SOI=9⁰CA, IP=19.5MPa, Ratio=22.5%PO) has a remit with highest value. This also means that the optimization process has found the optimal control factors for diesel engine 6LU32 and SOI=9⁰CA, IP=19.5Mpa, mixed fuel PO22.5 can be selected to set optimum working parameters for diesel engine 6LU32 to use the alternative fuel to substitute the conventional fuel.

4 CONCLUSIONS

Resetting operation parameters of marine diesel engines is allways necessary for any change of using a new fuel, especially using mixed fuel (alternative fuels). The above mentioned method has been applied to reset the technical parameters of fuel supply system of marine diesel engine 6LU32 for the purpose of using the mixed fuel (pure palm oil & DO) and these gave very positive results. So, there can draw some conclusions that:

- The response surface method is good tool to optimize the working parameters of a marine diesel engine when the diesel engine is converted to use mixed fuel (alternative fuel) to replace the conventional fuel (fossil) in order to achieve the objective of environment protection and energy saving. After re-setting in accordance with newly chosen parameters (SOI, NOP, mixing ratio) by above mentioned method for fuel supply system, the marine diesel engine has been working well with proper exhaust gas emission (NO_x) and fuel consumption;
- The optimization method is simple and very practical one and it can be applied in order to re-sett technical parameters of a fuel supply system for any marine diesel engine when it will use an alternative fuel to substitute conventional one.

However, the investigation is just beginning and the investigation results are collected from one diesel engine. So, for more practical application, there needs further development of the method and applications should be carried out on existing ships.

REFERENCES

- [1] M.E.Tat and J.H. Van Gerpen; *Measurement of Biodiesel Speed of Sound and Its Impact on Injection Timing*; Department of Mechanical Engineering Iowa State University Ames, Iowa; USA February 2003;
- [2] Taewon Lee and Rolf D. Reitz; *Response Surface Method Optimization of a HSDI Diesel Engine Equipped with a Common Rail Injection System*; Internal Combustion Engine Division Fall Technical Conference; October 2015;
- [3] Nuran Bradley; *The Response Surface Methodology*; Master of Science in Applied Mathematics & Computer Science, Indiana University South Bend, USA 2007;
- [4] Montgomery, David T.; *An investigation in optimization of Heavy-Duty diesel engine operating parameters when using multiple injection and EGR*; D. Thesis, University of Wisconsin-Madison,2000;

- [5] John B.L Heywood; *Internal Combustion Engine Fundamentals*; 1988 by McGraw-Hill;
- [6] Dang Van Uy & Research Team; *Research and develop a technology solution in order to convert marine diesel engines of small and medium scale to use blended straight vegetable oils as alternative fuel*, No.04.11/NLSH, Haiphong 2014;
- [7] Dang Van Uy & Research Team; *An Investigation to Design and Manufacture a ECU for Marine Diesel Engines Using Blended Fuel (DO & Vegetable Oils)*; Vietnam Ministry of Industry & Commerce, Hanoi 2017;
- [8] Dang Van Uy & Research Team; *To Build up Technical and Management Solutions in Order to Decrease Fuel Expenditures for Vietnam National Ocean Fleet*; Ministry of Transportation, Hanoi 2014;

HYBRID GAS-ELECTRICAL POWER & HEAVY DUTY PROPULSION: TEST PLATFORM

R. Bosch^{1,3}, P. Casals-Torrens^{1,3}, J. Alvarez-Florez², Alexandre Serrano-Fontova¹

¹Department of Electrical Engineering

²Department of Thermal Machinery

³Barcelona School of Nautical Studies (FNB)

Universitat Politècnica de Catalunya – BarcelonaTech

Pla de Plau, 18, 08003 Barcelona, Spain

e-mail: alexandre.serrano@upc.edu, web page: <http://www.fnb.upc.edu>

Keywords: Hybrid power systems, liquefied natural gas, heavy-duty propulsion systems, electrical systems, small vessels, technology impact, control and regulation, mariner engineers, training, education.

Abstract. This paper presents the results and discussion of an extensive set of tests of a hybrid generation system (gas-electric), to feed the electric motors which propel a small or medium vessel. Primarily, the hybrid electric system includes An otto cycle combustion engine, an electric generator and electric induction motors. The diesel engine represents the central part in regards to the propulsion task [1][2]. Thus, it provides the energy required by the electrical system, also supports load variations at low speed or cruising speed. Furthermore, it feeds other critical loads such as lights, electronic navigation systems, ancillary systems and other comfort loads within the hotel facilities. Presently, many technical challenges associated with the design of hybrid-electric propulsion systems are under discussion. Regarding technical limitations, the loading level and perhaps even more important is to deal with the complexity of the hybrid systems. Concerning to technical limitations, we can, therefore, highlight the following issues; the pilot excitation control, the performance of crash-stop manoeuvre and lastly the protection and control task.

1 INTRODUCTION

Albeit the most common type of propulsion in the maritime field are the engine-motors with an implemented propeller, however, in the recent years the interest to promote the electrical propulsion, have become a topic of undeniable scientific scrutiny. The aim of this interest is twofold; on the one hand, the reduction of the emission gases by using natural gas (NG) as a primary raw material [3]. Secondly, to test the behaviour of the electrical motors in regards of marine propulsion purposes. Accordingly, the required elements to accomplish this type of propulsion are as follows: a heat engine operating an Otto cycle due to NG, a synchronous generator, the generator control systems and the electric motors. This paper shows the theoretical analysis of this electrical system its main features, the results of several tests carried out to validate the hypothesis. From the tests performed, it can be safely concluded that the system under investigation competes favourably and is capable of overcoming the severest

system contingencies regarding the direct on-line start motors [4][5][6]. Lastly, it is crucial to note that the present study reveals the fact that, not only the ship is able to continue operating after a sever contingency but also the protection systems are properly designed so as to not misscoordinate in these scenarios.

2 TEST SYSTEM COMPONENTS DESCRIPTION

This section devotes to enumerate and make a thorough explanation of the elements that compose the system under investigation. The test platform was the whole system could be observed is depicted in Fig. 1. From this figure, it is possible to observe the heat engine, the generator coupled with it, the induction machines and the system control that contain the circuit breakers (CB) and the adjustable-speed drive (ASD).



(a) Test platform



(b) Electric propeller (offshore)

Figure 1: Test platform. Hybrid gas-electrical power & propulsion

2.1 Heat engine

The main element of the system is a heat engine, which acts as a prime mover. The data of the heat engine is detailed hereunder:

- Cycle Type: Otto
- Engine capacity: 8.8 litres
- N° of cylinders: 8
- Power output: LNG at (RPM) 1500 m^{-1} , 94 kW (50 Hz); (RPM) 1800 m^{-1} , 113 kW (60 Hz)
- Power output: NG at (RPM) 1500 m^{-1} , 82 kW (50 Hz); (RPM) 1800 m^{-1} , 99 kW (60 Hz)
- Engine in late [mm Hg] at (RPM) 1500 m^{-1} 26 y (RPM) 1800 m^{-1} 31.6
- The mass flow rate of LNG at (RPM) 1500 m^{-1} 23 y (RPM) 1800 m^{-1} 59

As can be seen, the power output, operating at the synchronous speed, that is to say, at 50 Hz and using LNG as a prime material, the output engine is 94 kW.

2.2 Electrical generator

This section aims at detailing the electrical generator, which uses the prime mover defined in the previous section to generate the required electrical power. The electrical generator is a brushless permanent magnet synchronous generator (PMSG). Specifically, the electrical generator incorporates a droop control system in regards the active-power/ frequency and

reactive-power/voltage playing a pivotal role in transient studies during sever changes. Firstly, the frequency system control refers to the governor system, modifying the engine mass flow rate input to increase or decrease the torque applied to the shaft. Secondly, in the sense of voltage profile, the generator incorporates an automatic voltage regulator (AVR) to regulate the reactive-power injected. Purposefully, the electrical generator acts in fact, as a swing bus. The main features of the generator are detailed below:

- $S = 175 \text{ kVA}$
- $V = 400 \text{ V}$
- $I_n = 252 \text{ A}$
- $I_{\text{short-circuit}} = 752 \text{ A}$
- $\text{Mass} = 659 \text{ Kg}$
- $\text{Inertia} = 1.93 \text{ kgm}^2$

where S is the rated apparent power, V is the rated output voltage, I_n represents the current voltage at rated power, $I_{\text{Short-circuit}}$ is the current during a solid short-circuit at the main terminals. The electrical characteristics of the generator are detailed below:

- Permanent reactance, direct axis (X): 1.85 p.u
- Transient reactance, direct axis ($X'd$): 0.16 p.u
- Subtransient reactance, direct axis ($X''d$): 0.11 p.u
- Permanent reactance, quadrature axis (Xq): 1.12 p.u
- Subtransient reactance, quadrature axis ($X''q$): 0.15 p.u
- Leakage reactance (Positive sequence) (X_l): 0.07 p.u
- Negative sequence reactance (X_2): 0.11 p.u
- Zero sequence reactance (X_0): 0.07 p.u
- Transient time constant ($T'd$): 0.042 s
- Subtransient time constant ($T''d$): 0.012 s
- Transient time constant ($T'd$): 0.042 s
- Field time constant (T'_{do}): 1.1 s
- Armature time constant (T_a): 0.012 s
- Base rating for reactance values: 175 kVA
- Permanent short circuit current of the machine is 1.4 kA.

2.3 Induction machines

Since the induction motors (IMs) are the elements responsible of the propulsion coupled with the propellers, the parameters not only in steady state but also in the transient process are crucial. Purposefully, the data of the IMs is detailed further on:

1. IM A: 55 kW

$S_n = 55 \text{ kW}$, $V_n = 0.38 \text{ V}$; $I_n = 445 \text{ A}$; $I_s = 720 \text{ A}$, $I_0 = 27 \text{ A}$; $J = 0.8 \text{ kgm}^2$, $f = 50 \text{ Hz}$, $\text{pf} = 0.85$

2. IM B: 22 kW

$S_n = 22 \text{ kW}$, $V_n = 0.38 \text{ V}$; $\text{pf} = 1$ $I_n = 230 \text{ A}$; $I_0 = 10 \text{ A}$; $I_s = 240 \text{ A}$ $f = 50 \text{ Hz}$, $J = \text{kgm}^2$, $\text{pf} = 0.85$

where V_n is the rated voltage, I_n is the rated current, I_0 is the no-load current, I_s is the starting current, p represents the IM pole pairs, J the inertia of the IM, f is the rated frequency and lastly, pf is the rated power factor. The electrical parameters of the machine A and B are respectively;

1. IM A: $r_s=0.038 \Omega$, $r_r=0.045 \Omega$, $l_r = 2.38e^{-2} \text{ H}$, $l_s=2.38e^{-2} \text{ H}$, $l_\mu=2.2e^{-2} \text{ H}$
2. IM B: $r_s=0.13 \Omega$, $r_r=0.15 \Omega$, $l_r = 4.9e^{-2} \text{ H}$, $l_s = 4.9e^{-2} \text{ H}$, $l_\mu=4.85e^{-2} \text{ H}$

Finally, note, however, that the third motor (IM C), is equal to IM B.

2.4 Excitation system

As a brushless generator, the automatic voltage regulator (AVR) forms part of the excitation system, that is, the excitation power required by the PMSG. The AVR senses the altern current (AC) signals at the main generator winding and controls the excitation in order to maintain the generator output voltage within the specified limits. On the other hand, the maximum excitation is limited to a short period for safety, and in case it is exceeded, the AVR will be shut down. The AVR data is listed below:

- AC Power input from the PMSG (Max. values): $V_n= 170\text{-}220 \text{ V}$, 3 phase, 3 wire, $I_n= 3 \text{ A/phase}$ and $f = 100\text{-}120 \text{ Hz}$.
- DC Output of the AVR (Max. values): $V_n= 120 \text{ V}$, $I_n= 3.7 \text{ A}$ (permanent) and $I_{\max}= 6 \text{ A}$ (for 10 s)

On the second hand, the protections incorporated in the generator are listed below:

- Under frequency protection (UFP): The UFP is set to 95 % of the rated frequency, that is, 47,5 Hz, a slope of frequency of 100-300% below the 30 Hz, and also a maximum swell of 20% at the recovery is accounted.
- Overcurrent protection: The current limiter acts in case of a fault, and besides to limit the starting current of the generator. The protection considers a 10 s time delay.
- Over voltage protection (OVP): The OVP is set to 300 V with a fixed time delay of 1 s.
- Over excitation protection (OEP): This feature, allows the system to shut down the system in case of the DC field voltage of the excitation system exceeds 75 V considering a time delay of 8-15 s.
- Dip/Swell adjustment: These settings belong to a drop in voltage as well as an under-voltage (voltage dip) and an over-voltage (Swell), limiting the increasing volts per hertz (V/Hz). For our purposes, these settings are disabled.
- Droop control: The system, as a unique generator, it is acting as a swing bus considering droop adjustment to regulate 5% of voltage drop at full load zero power factor. Secondly, the stability adjustment is expected to control the relation V/Hz within the stable boundaries for a good transient and steady-state response. Additionally, the governor system acts by adjusting the mass flow rate of so as to increase the torque applied to the shaft and increase the active-power.

3 THEORETICAL ANALYSIS

The present section seeks to address the transient stability during the transient behavior of the IMs during its starting and also the transient system response under severe changes in load torque during operation. Since the PMSG is the unique generator, the classical theory of stability applied to our isolated system. Regarding system stability, this section recalls the theory basics briefly in the case of study. As a matter of fact, the magnitudes involved are normally analyzed separately in powers system stability and is as follows: voltage angle stability, voltage stability and frequency stability [7], which in turn, these are highly linked between each other, especially here. It is nonetheless important to note that, depending on the severity of the disturbance, the stability can be a large disturbance and small disturbance. Herein, the system stability is discussed for the particular system defined in the previous section and is detailed hereunder.

The set of equations which govern the transient behaviour are considered by the set of differential-algebraic equations (1):

$$\begin{aligned} \frac{d\omega_i}{dt} &= \frac{\omega_o}{2H} [Pm_i - Pe_i(\delta_i) - \frac{D_i}{\omega_o} (\omega_i - \omega_o)] \\ \frac{d\delta_i}{dt} &= \omega_i - \omega_o \end{aligned} \quad (1)$$

$$\Delta\delta = \int \Delta\omega dt = 2\pi \int \Delta\delta dt \quad (2)$$

$$\begin{aligned} Pe_i &= \Re\{E_i I_{i,g}^*\} = \frac{E_i U_g}{jX'_i} \sin \delta_i \\ I_{i,g}^* &= \frac{E_i - U_g}{jX'_i} \end{aligned} \quad (3)$$

where P_g is the mechanical power of the generator in node i , P_{ei} is the electrical power delivered by the generator i , respectively. P_{ei} can be computed as in (3) D_i is the damping factor of generator i , ω_i is the electrical speed of every i generator, ω_o is the synchronous electrical speed and H_i inertial constant for each one, E_i is the generator voltages and δ_i is the generator phase angle behind the synchronous reactance ($E_i \angle \delta_i$), U_g is the voltages of the generators after the transient reactance, I^* is the conjugated current, jX'_i the transient reactance of each generator and $i=1$. E_i is the generator voltages of each one, B_{ij} is the line susceptance and G_{ij} the line conductance, both can also be expanded into generator buses. The compact expression of (1), is given in (3).

$$\begin{aligned} \dot{x} &= F(x, u) \\ 0 &= g(x, u) = YU - I_i(x, u) \end{aligned} \quad (3)$$

where x is the state vector, \dot{x} is its derivative, F is sufficiently differentiable, Y is the admittance matrix of the system considering the loads and lines, U is the bus voltages of this buses and I_g the current injected by the unique generator, which at same time depend on the state variables

and also on the voltage buses. In our particular system, the state vector is composed by the transposed vector defined in (4):

$$x^T = [\delta_g, \omega_g] \quad (4)$$

In this stage, it is crucial to point out that, if the rotor of the machine the angular speed increases, therefore, the angle gets unstable and the frequency of the system will also be increased, whilst in case that the speed decreases, the angle will also be unstable and, the system will reach an under frequency operation. In this sense, it is essential to consider the generator inertia, which acts by damping the system. Notwithstanding the preceding, the frequency oscillation, as is observable from (2) is related to the rotor speed, wherewith the frequency drop will be evaluated to observe the system response against the severe requirement in IM starting.

Since the severest transient accounted here is an IM starting, where the required power is mainly reactive, the voltage dip duration and deep depend essentially on the required time to reach the stable operation and secondly on the relation between the short-circuit ratio (S_{sc}) in p.u. where the IM is connected and the starting current. As a consequence, the short circuit ratio and is considered in (5) and the root-mean-square (RMS) permanent three-phase short circuit at the point of common coupling (PCC) is calculated in (6):

$$S_{sc} = \frac{1}{jX_d} \quad (5)$$

$$I_{sc} = \frac{S_{sc}}{\sqrt{3} \cdot U_n} \quad (6)$$

where the jX_d is the direct-axis reactance of the machine in p.u. Since the reactance of the IM during the starting process is variable and depends directly on its slip, the expected RMS voltage value during this transient process, depends on the relation between the short-circuit power value at the PCC, which belongs in this case to the short-circuit power at the generator terminals and the IM starting current.

The stability is controlled by the AVR which has the capability to increase or decrease the third term of the equation defined in (1). Consequently, this term can be otherwise expressed as (7):

$$\frac{D_i}{\omega_o} (\omega_i - \omega_o) = k_2 \Delta E_q' \quad (7)$$

Considering that the term $\Delta E_q'$ makes changes in the machine flux, by increasing or decreasing field voltage and k_2 is a constant, it is worth noting that this term can enhance the system stability, by damping the oscillations. Thus, the AVR acts increasing the system stability and is of utmost importance to consider its time response.

4 TEST MEASUREMENTS

4.1 Test 1

This test considers the direct on-line starting of the IM A to observe the response of the generator in these conditions and also to detect if the system is close to a voltage or frequency

collapse.

Here, in Fig.2 it is easy to observe the fact that a voltage dip occurred during the motor starting, the values during this process are summarised below:

- $I_s=480$ A; $I_s(t=1s)=130$ A , $I_o= 27$ A
- $V_{RMS}= 150$ V

The IM takes 540 ms to reach its rated speed, due to the starting current the voltage dip is observed, however, the voltage recovery takes place after 620 ms. In this sense, the voltage regulator senses the over-voltage and injects the required reactive power to recover the situation. Unfortunately, the accuracy of the AVR regarding its time-response reaches an over-voltage following the IM recovery. The AV produces this slight oscillation. In addition to the above mentioned earlier, and expected from the theoretical analysis, the frequency oscillation of 18 Hz takes place the first ms and afterwards and thanks to the AVR operation, the system recovers.

The active and reactive powers are depicted in blue and pink respectively, the voltage and current waveforms and its respective RMS values (V_1 red, V_2 green, V_3 blue) and lastly the frequency value is plotted in black.

4.2 Test 2

This test considers the direct on-line starting of the IM B in order to observe the response of the generator in these conditions and also to detect if the system is close to a voltage or frequency collapse.

Here, in Fig. 3 it is easy to observe the fact that a voltage dip occurred during the motor starting, the values during this process are summarised below:

- $I_s=180$ A; $I_s(t=1s)=100$ A , $I_o= 10$ A
- $V_{RMS}= 300$ V

The IM takes 164 ms to reach its rated speed, due to the starting current the voltage dip is observed. However, the voltage recovery oscillation lasts 1.5 s due to the time-response of the AVR system. In this sense, the voltage regulator senses the over-voltage and injects the required reactive power to recover the situation. In this stage, the over-voltage post-recovery is weaker because the lower is PCC voltage droop, the higher is the AVR voltage excitation increasing. As commented in the previous test, and expected from the theoretical analysis, the frequency oscillation of 8 Hz takes place the first ms and afterwards and thanks to the AVR operation, the system recovers.

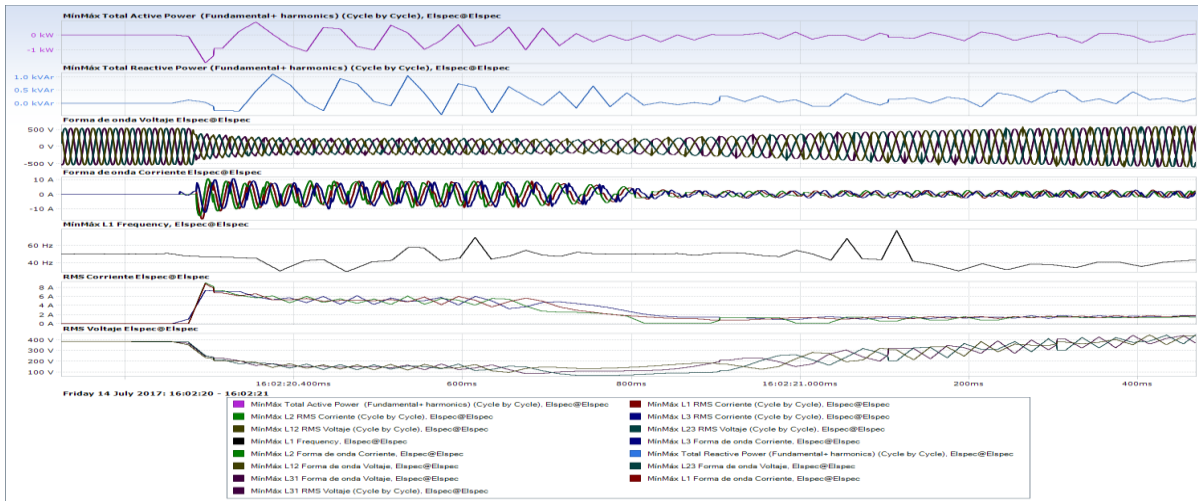

Figure 2: Electrical parameters of TEST 1

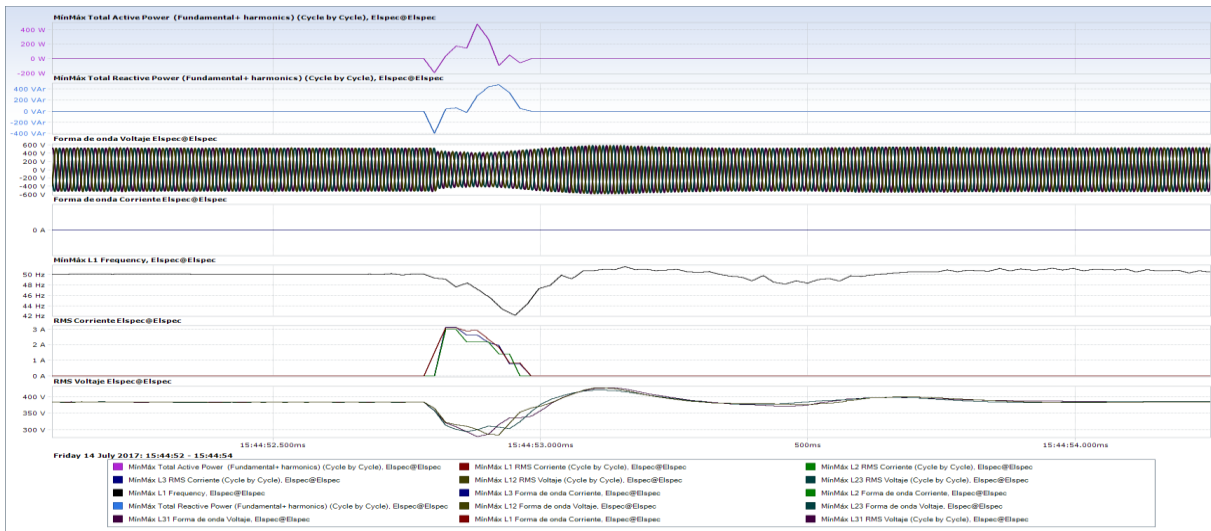

Figure 3: Electrical parameters of TEST 2

The active and reactive powers are depicted in blue and pink respectively, the voltage and current waveforms and its respective RMS values (V_1 red, V_2 green, V_3 blue) and lastly the frequency value is plotted in black

4.3 Test 3

This test considers the direct on-line starting of the three IMs in the following order; firstly, the IM B, afterwards the IM A and lastly the IMC. In these conditions, it is possible to observe the effects of a full test as well as to detect if the system is close to a voltage or frequency collapse not only during starting but also during steady-state operation. Here, in Fig.1 it is easy to observe the fact that a voltage dip occurred during the motor starting, the values during this process are summarised below:

- $I_s=180$ A, $I_o= 10$ A (Motor B)
- $I_s=480$ A, $I_o= 28$ A (Motor B+A)
- $I_s=172$ A, $I_o= 55$ A (Motor B+A+C)
- $I_o= 41$ A (Motor A+B)
- $I_o= 28$ A (Motor A)

The results from the previous subsections 4.1 and 4.2 are equally observable here, note, however, that the no-load current is now an important factor. As can be seen in Fig. 4 the frequency and voltage drop during starting IM B and C are similar, but the drop in IM C is lower, and this is because IM A and B are acting transiently as generators during its starting. The active and reactive powers are depicted in blue and pink respectively, the voltage and current waveforms and its respective RMS values (V_1 red, V_2 green, V_3 blue) and lastly the frequency value is plotted in black.

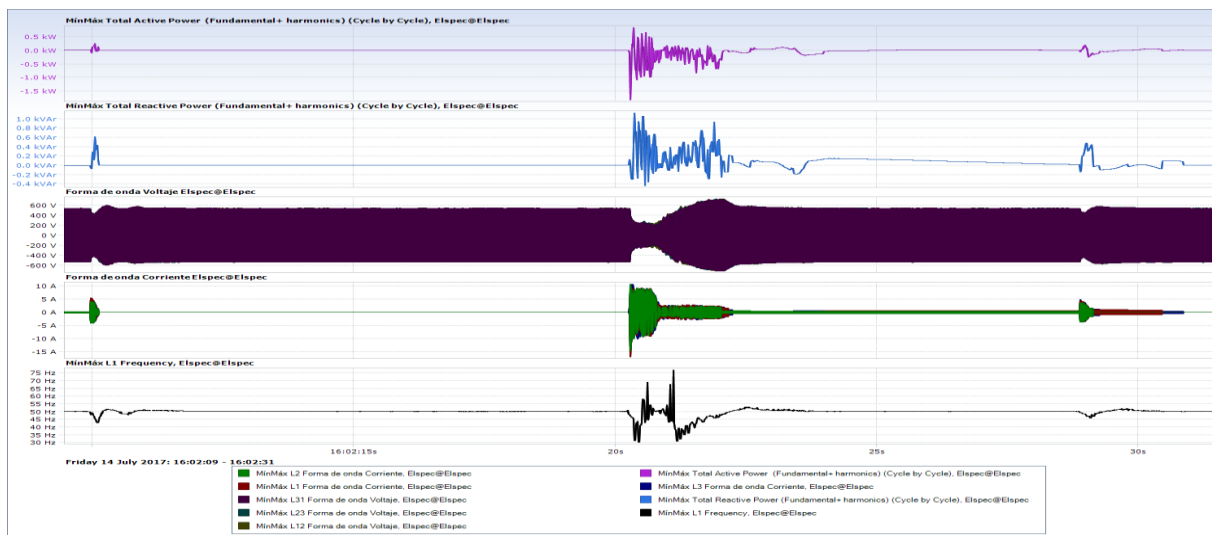

Figure 4: Electrical parameters of TEST 3

6 CONCLUSIONS

At first sight and observing the tests carried out it seems altogether reasonable and logical to assert that the system will remain stable following the severe transients, regarding voltage and frequency.

Firstly, it can be seen that for the most severe transient, as expected, occurs during IM A starting and the temporary system loss of frequency and voltage is relevant, however, after 540 ms the system recovers. We can safely conclude that, in these conditions and considering a temporary droop, the frequency and voltage oscillations are within acceptable boundaries and do not produce protective nuisance tripping.

Secondly, the performance of the AVR competes favorably and assures that the system will remain stable following all possible disturbances. As a matter of fact, during a 0.6 deep voltage droop, the under-voltage does not trip, which is crucial in maritime operations.

Thirdly, it is also a transcendental factor to consider the system inertia, considering that the heat-engine output is 90 kW and the electrical generator is 175 kVA, this fact reveals that the rotating masses reduces the frequency droop and also enhances the system stability. Therefore, oversizing the electrical generator, we achieve a less reduction in voltage and frequency in the heaviest requirements because the total inertia of the shaft (engine plus generator) is acting as a “kinetic energy recovery system”.

Fourthly, it has been demonstrated that the propeller power is proportional to the absorbed current, which will result in a valuable mnemonic tool to engineering officers in engine room. In this sense, this tested platform seems to be suitable not only for academic purposes but also for the private maritime company training personnel. Additionally, the system accounted here will help in reducing the CO₂ emissions, which is one of the main short-term concerns in maritime transportation and besides, it has been proved that an LNG-based engine with a set of IM is capable of propelling the system and notably enhances the time response of the ship. Especially, in the most challenging operations such as the “crash stop,” when this is particularly crucial in preventing hazardous events.

Lastly, the immersed IM within an IP 58 protection, allows its vertical subjection, and as a consequence, the group improves its propeller mobility, which, in turn, helps the system in addressing extreme situations.

ACKNOWLEDGEMENTS

The authors would like to wholeheartedly thank the financial support and the great willingness to collaborate towards this project of GECRIO, SEALINK and GAS NATURAL FENOSA. Undoubtedly, without these private efforts, the project would have been impossible to carry out.

REFERENCES

- [1] J. L. Kirtley, A. Banerjee, and S. Englebretson, “Motors for Ship Propulsion,” *Proc. IEEE*, vol. 103, no. 12, pp. 2320–2332, 2015.
- [2] Z. Liu, J. Wu, and L. Hao, “Coordinated and fault-tolerant control of tandem 15-phase induction motors in ship propulsion system,” *IET Electr. Power Appl.*, vol. 12, no. 1, pp. 91–97, 2018.
- [3] G. Sulligoi, A. Vicenzutti, and R. Menis, “All-Electric Ship Design: From Electrical Propulsion to Integrated Electrical and Electronic Power Systems,” *IEEE Trans. Transp. Electrification*, vol. 2, no. 4, pp. 507–521, 2016.
- [4] Tanneeru, J. Mitra, Y. J. ; Patil, Y.J. ; Ranade, S.J. Effect of Large Induction Motors on the Transient Stability of Power Systems. Proceedings of the 39th North American Power Symposium: NAPS 2007, Las Cruces, NM, United States, pp. 223–228, 2007.
- [5] J. C. Das, “Effects of Momentary Voltage Dips on the Operation of Induction and Synchronous Motors,” *IEEE Trans. Ind. Appl.*, vol. 26, no. 4, pp. 711–718, 1990.
- [6] D. S. Brereton, D. G. Lewis, and C. C. Young, “Representation of Induction-Motor Loads During Power-System Stability Studies,” *Trans. Am. Inst. Electr. Eng. Part III Power Appar. Syst.*, vol. 76, no. 3, pp. 451–460, 1957.
- [7] P. Kundur *et al.*, “Definition and Classification of Power System Stability IEEE/CIGRE Joint Task Force on Stability Terms and Definitions,” *IEEE Trans. Power Syst.*, vol. 19, no. 3, pp. 1387–1401, 2004.

RESEARCH AND MANUFACTURING OF HIGH-MECHANICAL COPPER ALLOYS FOR SHAFT LINERS

VU ANH TUAN^{1,2}, TRAN THE NAM^{1*}, NGUYEN DUONG NAM^{1**}

AND PHAM MAI KHANH^{2*}

¹ Viet Nam Maritime University
No 484, Lach Tray Street, Le Chan District, Hai Phong, Viet Nam
e-mail: ^{1*}thenam@vamaru.edu.vn, ^{1**}namnd.khcs@vamaru.edu.vn,
web page: <http://www.vamaru.edu.vn>

² School of Material Science and Engineering
Ha Noi University of Science and Technology
No 01, Dai Co Viet Street, Hai Ba Trung District, Ha Noi, Viet Nam
Corresponding: ^{2*}khanh.phammai@hust.edu.vn, web page: <http://www.hust.edu.vn>

Keywords: copper alloy; shaft liner; intermetallic; abrasion resistance; heat treatment process

Abstract. This article presents the results of research and manufacturing of copper alloys with good mechanical synthesis to manufacture shaft liners. The results show that CuAl10Fe4Ni2 alloys are reasonably heat treated; The hardness value achieved is 105HRB and the mass loss is 0.1044g. Further, by SEM; EDS and TEM, we have identified intermetallic phases as fine Fe₃Al and fine NiAl dispersed on the microstructure. These phases have increased the hardness and wear resistance for this alloy.

1 INTRODUCTION

The shaft liners usually are lubricated with natural water; This is an easily corroded environment, especially with electrochemical corrosion. In addition, the position where the shaft works with its bearing is subject to a large load. Therefore, to protect the shaft and create a good friction, it is often necessary to cover the steel shaft with a component called shaft liners.

The shaft liners are mounted in a slidable mounting mode with the shaft in the position where the shaft works directly with the bearing, in direct contact with the seawater. When working the shaft liners work under the load and the following harm: The suspension shaft has a resilience to the shaft, so the shaft liners are initially stressed due to the bucket. Torsional tension due to average torque on the shaft; Stress changes due to twisting, bending and deformation; Pulled by compressed shafts; Abrasion due to contact with sea water and abrasion-resistant when working with bearings.

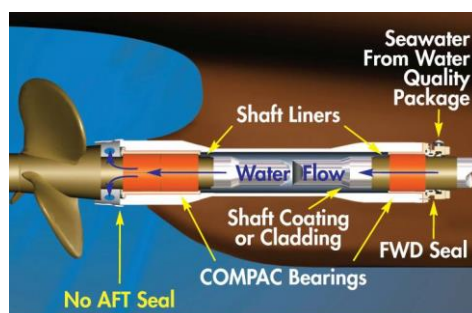

Figure 1: Location of shaft liners

As such, the shaft liners are subject to variable loads, abrasion and corrosion resistance, so the ship shaft is often damaged due to fatigue; abrasion resizing. If there is a slippage that leads to abrasion, rust on the contact surface

Due to the special working conditions, the shaft liners must to have a special mechanical property; that is resistance against abrasion.

Under the same working conditions, the copper alloys are commonly used today. Copper alloys have a variety of mechanical mechanisms, such as the spinodal decomposition mechanism, martensite phase transition and dispersing phases, alloying and intermetallic phase. In this study, we are studied about the copper alloys which added of iron and nickel alloys combined with heat treatment producing martensite transformation, disperse γ_2 and intermetallic phases. [1,2,4,7]

Copper-aluminum alloy has some more highly mechanical and technological properties compared to other copper alloys. When it is alloyed with iron and nickel, intermetallic phases are created, increasing durability by heat treatment.

Iron dissolves in aluminum very little; when iron content increases, it will form intermetallic phase Fe_3Al ; if this phase is fine-grained in the form of spheres, and it distributes evenly in the microstructure, the mechanical properties of the alloy will be improved. Iron is a good element in the copper-aluminum alloys because it enhances the crystalline temperature, fine grain, durability, hardness and the wear resistance of the alloy. The intermetallic phase is generated around α , across the boundary and also inside phase β , preventing the phase difference of phase β and reducing the velocity of the reaction with eutectoid $\beta \rightarrow (\alpha + \gamma_2)$; Therefore, if the phase γ_2 is made, it is fine-grained and dispersed evenly throughout the structure, and it overcomes the self-composting phenomenon of aluminum-copper bar to improve durability, hardness and significant wear resistance for alloys as well [3,4].

Phase α of copper-aluminum alloys can dissolve up to 4% iron as the higher iron content produces the intermetallic phase Fe_3Al . Iron has a denaturing effect on the microstructure of the copper aluminum alloys, improving durability, hardness, and lubricity along with reducing the tendency of embrittlement of 2-phase bromine due to slowing down the eutectoid decomposition of phase β and separation of phase γ_2 [6].

In addition, the alloy is added Nickel which dissolves infinitely in copper but very little soluble in aluminum. Ni improves the mechanical properties of the alloy, however, it contributes to increased resistance to abrasion and works at low temperatures. When implementing the quenching process, this alloy was formed martensitic microstructure based

on 3R structure (or 18R) or 2H; these two types are commonly called β 'or γ '. Continuing to implement the tempering process, the alloy will form the intermolecular phase based on electronic compound NiAl, Fe₃Al simultaneously the background is the copper-rich solid solution [3,5,6].

From the results of the theoretical analysis, the article presents about the results of research and manufacturing the copper and aluminum alloys are alloyed with 4% Fe and 2% Ni to increase the wear resistance of this alloy.

2 EXPERIMENTAL PROCEDURE

In the results of the research group, the team made a copper alloy with 10% of Al; 4% of Fe and 2% of Ni.

Table 1: Component of this alloy

| Elements | Al | Fe | Mn | Ni | Sn | Zn | Pb | Si | Cu |
|----------|------|------|------|------|------|------|------|------|------|
| (%) | 9,41 | 4,98 | 0,15 | 2,44 | 0,04 | 0,49 | 0,07 | 0,07 | Bal. |

This alloy is heat treated to ensure its homogeneity at 850°C for 2 hours, then quenched in water and aging tempered at 350°C in 02 hours. The samples after treatment were analyzed microstructure, hardness, and abrasion resistance. Xray analyzes were conducted at the Faculty of Physics, Hanoi National University. The microstructure of the sample being studied Axiovert optical microscope 25A, scanning microscope JEOL - JSM 7600F. The results of the study on SEM images were made at the Electronic Simulation Laboratories - Advanced Institute of Science and Technology - Hanoi University of Technology. Also in this report, the phase is analyzed by the transmission electron microscope at the Polytechnic University of Ho Chi Minh City. Mechanical properties of the samples are determined on ATKF1000 equipment.

3 RESULTS AND DISCUSSIONS

3.1 Microstructure

After casting



Figure 2: Microstructure of casting

After casting the microstructure consists of two phases, mainly phase α branching and dark phase is the phase ($\alpha + \gamma$) hard and brittle. In addition, on the microscopic image can also see some suspected phase is the alloy phase of Fe. However, it is difficult to detect these phases by optical microscopy

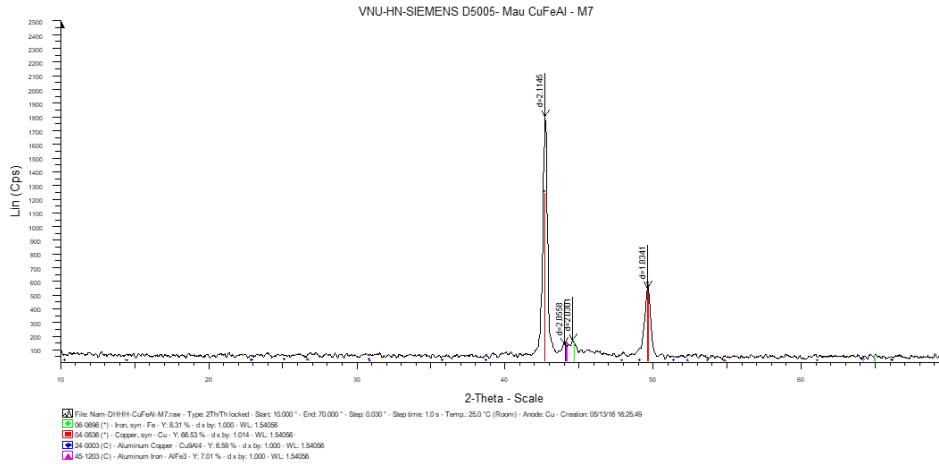

Figure 3: Xray of casting

By Xray analysis, it is found that: In the microstructure of the alloys, there are two phases in equilibrium: α and β . There is also the little phase of Fe alloys with Al. In the state of dissolved Ni dissolved in the unconformable copper phase.

After quenching:

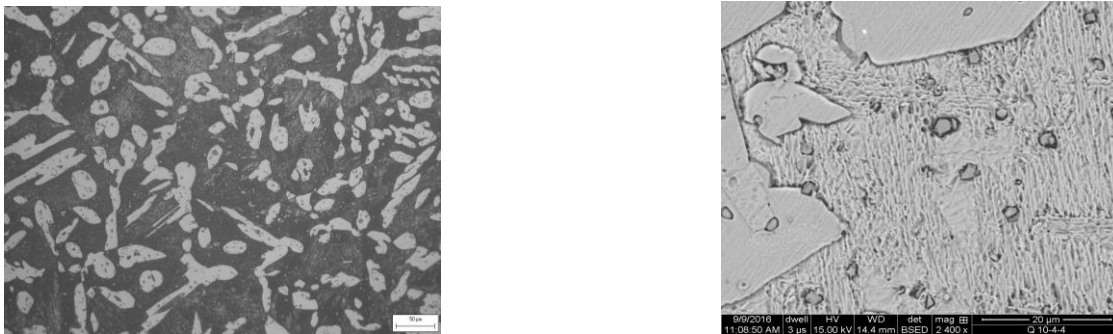

Figure 4: Microstructure of quenching

After quenching the analysis of the results found: The samples were heated and held to 850°C (heating to the α and β phase area) over a period of two hours and then cooled rapidly in water. The β -phase turns into β -martensite (sheet form). In addition, by optical analysis, the α phase is finer than the α phase after casting. By BSED analysis, a suspicious black phase is suspected. In addition, under the influence of Fe after heat treatment of the alloy phase will make the γ_2 secreted smooth and dispersed.

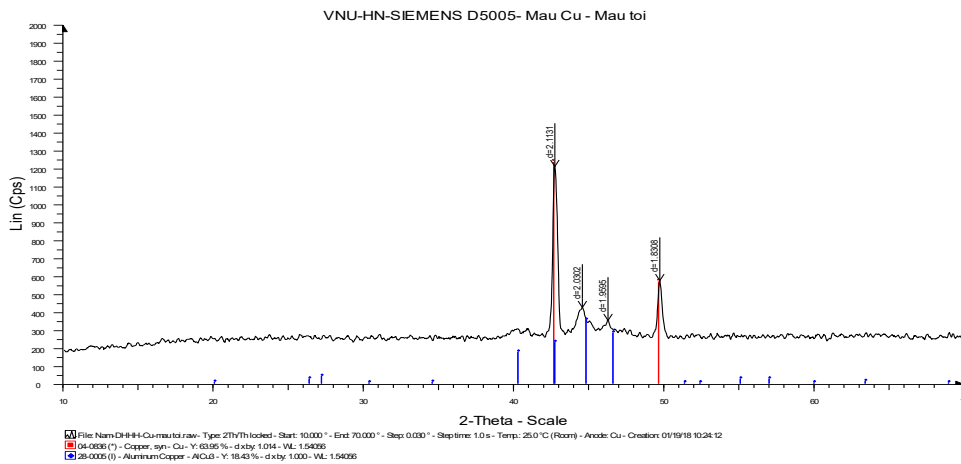

Figure 5: Xray of quenching

Xray analysis is mainly a solid solution of α and β' -phase. After quenching, if it was only by Xray analysis, it would be difficult to identify the intermetallic phases. Because these are very fine and scattered phases. Xray analysis only determines β' martensite (non-diffusive transition)

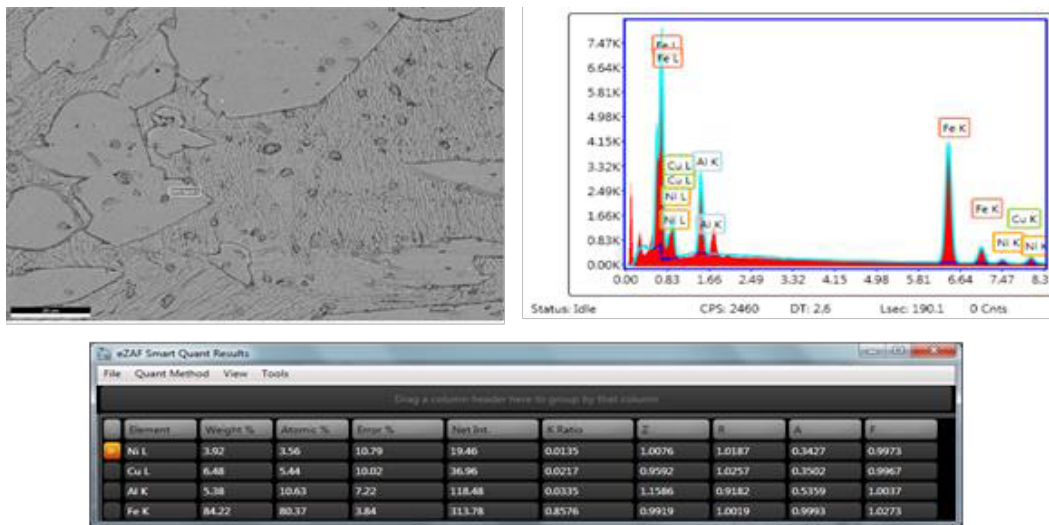

Figure 6: EDS of quenching

EDS analysis found that when analyzing the dark color phase, suspicions on the SEM image showed the peaks of the intermolecular phase between Ni and Fe and Al. These phases are very small in size and disperse evenly in the base of the alloy. It's high strength alloys that improve the hardness and wear resistance of alloys. In addition, when the phase of γ_2 phase metal is released in a small smooth and dispersed in the metal base.

After tempering

Analysis of the research results showed that:



Figure 7: Microstructure of tempering

The microstructure image analysis revealed that the post-tempering sample showed that in the microstructure, phase α was observed with a fine-grained size dispersed on the background. These phases would contribute to increasing hardness and resistance against abrasion of the alloy.

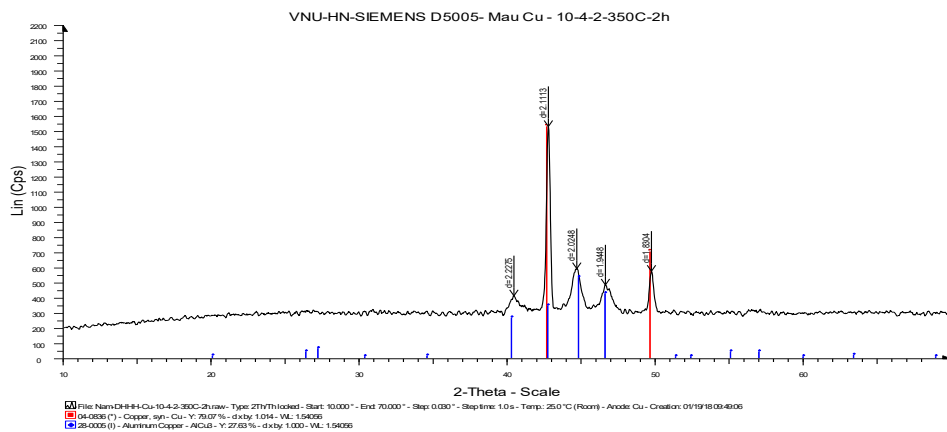
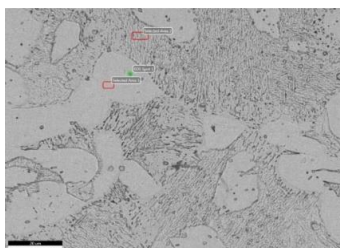

Figure 8: Xray of tempering



| Element | Weight % | Atomic % | Error % | Net Int. | R Ratio | Z | A | F |
|---------|----------|----------|---------|----------|---------|--------|--------|--------|
| Ni L | 5.29 | 5.14 | 5.64 | 30.71 | 0.0639 | 1.0308 | 1.0090 | 1.1745 |
| Cu L | 83.23 | 74.77 | 3.22 | 401.61 | 0.7066 | 0.9813 | 1.0120 | 0.9867 |
| Al K | 7.64 | 16.15 | 8.69 | 50.13 | 0.0425 | 1.1650 | 0.9066 | 0.9986 |
| Fe K | 3.84 | 3.80 | 22.69 | 5.29 | 0.0434 | 1.0201 | 0.9958 | 0.9954 |

Figure 9: EDS of quenching

EDS analysis showed the occurrence of intermetallic phases. These phases would contribute to increasing the hardness and resistance against abrasion of the alloy.

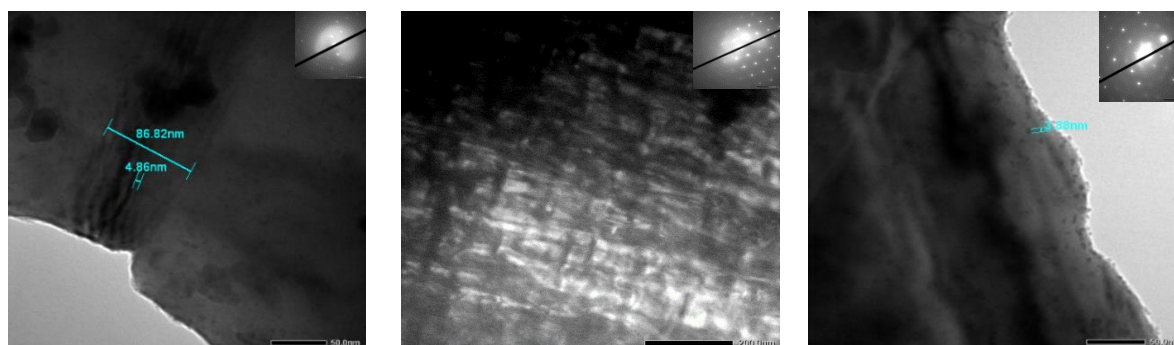

Figure 10. TEM and diffraction

TEM image analysis revealed the presence of fine-grained phases dispersed in the background. These phases increase the durability and wear resistance of the alloy.

The TEM image analysis after heat treatment showed that: When the heat treatment at the two-phase zone temperature occurs, Martensite is formed with two different forms of β' and γ' (Fig. and b). In addition, after the framework ram obtained the synthesis of copper-rich solid solutions of the fcc network type and electronic compounds NiAl and Fe_3Al . NiAl is released on the boundary of martensite. In addition, after the ram, the γ_2 phase is smooth and dispersed

3.2 Mechanical properties

The results of hardness

Table 2: Hardness of this alloy

| | Hardness (HRB) |
|-------------------------------|----------------|
| After casting | 95 |
| After quenching | 93 |
| After quenching and tempering | 105 |

Analyzing of the hardness value shows that after quenching and tempering process, the hardness of the alloy has the best value. After using the above processing, in the microstructure of this alloy, it has the phase of the metal which it dispersed; however, the microstructure has the fine phase γ_2 . The α phase with small dispersion is increasing the hardness of the alloy. This also causes the mass loss is reduced than the molding state and quenching state

The results of mass loss

Table 3: Mass loss of this alloy

| | Mass loss (gram) |
|-------------------------------|------------------|
| After casting | 0.1422 |
| After quenching | 0.1386 |
| After quenching and tempering | 0.1044 |

4 CONCLUSIONS

This paper presents the results of research and manufacture of fine copper alloys for use in fabrication of the ship shafts. The results show that aluminum alloys alloyed with 4% Fe and 2% Ni alloys and heat treated accordingly will increase the hardness (105HRB) and reduce the mass loss to 0.1044 in the same. a test condition.

The mechanical result is due to the fact that after the heat treatment of the sample with a small phase α ; the martensite phase (with low hardness) combined with fine phase γ_2 and fine phase alloys NiAl and Fe₃Al with high hardness, dispersive increase hardness and resistance to abrasion of the alloy.

REFERENCES

- [1] Dorgan, Y. Havvatoglu. Application of the infinitesimal deformation approach to the martensitic transformation observed in a Cu–Al–Ni alloy. *Physica B* 327, 2003, pp. 20–26.
- [2] Mustafa Yasar, Yahya Altunpak. The effect of aging heat treatment on the sliding wear behavior of Cu-Al-Fe alloys. *Materials and Design* 30, 2009, pp. 878-884.
- [3] M.A. Suarez, R. Esquivel, J.Alcantara, H. Dorantes, J.F. Chavez. Effect of chemical composition on the microstructure and hardness of Al-Cu-Fe alloy. *ScienceDirect*, 2011, pp. 917-923.
- [4] H. Warlimont. Microstructure, crystal structure, and mechanical properties of martensite phases in copper alloys
- [5] Yuanyuan Li, Tungwai Leo Ngai, WeiXin. Mechanical friction and wear behaviors of a novel high-strength wear – resisting aluminum bronze. *Wear* 197, 1996, pp. 130-136.
- [6] L.L.Gao, X.H. Cheng. Microstructure and dry sliding wear behavior of Cu-10%Al-4%Fe alloy produced by equal channel angular extrusion. *Wear* 265, 2008, pp. 986-991.
- [7] Le Thi Chieu, Sai Manh Thang, Nguyen Duong Nam and Pham Mai Khanh. The Effect of Deformation on Microstructure of Cu-Ni-Sn Aging Alloys. *Engineering and Technology on Non-Ferrous Metals, Key Engineering Materials*, 2016, Vol. 682, pp. 113-118.

STUDY ON THE EFFECT OF CHANGING HULL RESISTANCES TO TURBOCHARGER OPERATION OF MARINE DIESEL ENGINE

V. QUAN PHAN^{*}, C.A. TRUONG PHAN^{}**

^{*} Faculty of Naval Architecture and Offshore Engineering, ^{**} Faculty of Marine Engineering
Ho Chi Minh City University of Transports (HCMC-UT)
2D3 St. Binh Thanh Dist. Ho Chi Minh City, Vietnam
E-mail: phanquan@otm.vn, Web : <http://www.utc.edu.vn>

Keywords: Hull Resistance, Turbocharger, Main Engine, Load Diagram, Compressor Surge.

Abstract. Ship's hull resistances will change in according to the ship's operation time, caused by several different reasons: the development of sea creatures clinging to the hulls; sea water corrosion and distortions of hulls; the abrasion and corrosion of propellers; the abrasion of driving shaft bearings etc... It is considered the changing of hull resistances is independent on the main engine turbocharger operation. In fact, this may cause some influences on the main engine. In this paper, we would like to study on the effect of turbocharger operation on main engine power due to the changing of hull resistances, as well as the inverse effect of power changing to the turbocharger operation. It's useful to design and select a suitable turbocharger for main engine, and prevent it dropping in unstable area, or not reaching the desired efficiency after short time operation. Otherwise, this research will advise the marine operators to deeply understand and avoid running the turbocharger at overload range, consequently the turbine blades are burnt, or turbocharger drops in the unstable surge margin operation.

1 INTRODUCTION

1. Introduction

Hull resistance is an important factor affected on the ship's operation. The ship's characteristic is to carry cargo, survey, research and serve other services at sea. So, most of hull immerses in the sea water. As sailing in water, the ship will be influenced by many external factors such as wave, wind, current, clung by sea creatures, and seaweed, or corroded, coating peeled off by friction, surface deformed due to collision, and propulsion system damaged. All will cause the hull resistance changing and increasing proportionally to the time of operation.

Studying the effect of changing hull resistance on the working condition of propulsion system, or turbocharger in focus is one of the important missions to assist marine architect engineers and operating engineers have general visionary in design, improve safety and effective operation of ship's propulsion system.

2. Ship's hull resistance

The operation of ship in water will create several actions against the direction of ship, which are called hull resistance. The ship's hull resistance in water includes resistance of external shell friction, pressure difference around ship, draft air... [1]. Here, we will study each kind of resistances on ship :

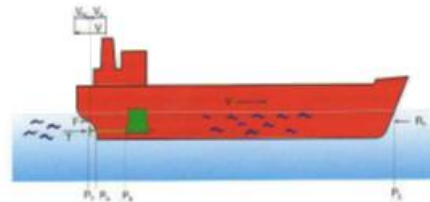

Figure 1. Ship's hull resistance

2.1 Frictional resistance R_F :

The frictional resistance of ship's hull depends on the wet surface area of the hull A_s and the frictional coefficient R_F . The resistance goes up as result of clinging of sea creatures, seaweed and rust on external shells. The frictional resistance increases to approximately the square of ship velocity and is about 70 - 90% of the total resistance for bulk carriers, oil tankers, or large low speed vessels. For high speed ships, the frictional resistance may reduce less than 40% [2].

The friction resistance is calculated as:

$$R_F = C_F \cdot K \tag{1}$$

2.2 Residual resistance R_R :

Residual resistance comprises the resistance of wave and eddy. The wave resistance refers to the energy loss caused by waves produced by the ship's sailing through the water. The eddy resistance is the least effect on the ship's operation, and often prevalent at the stern.

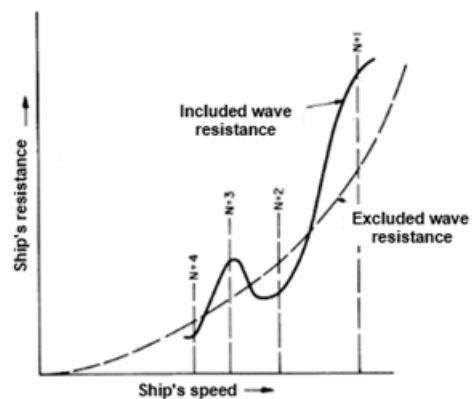

Figure 2. Ship's hull resistance diagram

The wave resistance at low speeds is proportional to the square of ship's velocity, and rapidly increases for high speed vessels.

From the ship’s hull resistance curves in figure 2 [1], as referring to the wave resistance, the residual resistance of ship’s hull will change under the effect of wave resistance, and vary around the the hull frictional resistance curve. The residual resistance is determined as [2]:

$$R_R = C_R \cdot K \tag{2}$$

2.3 Air resistance R_A :

In case of ship sailing in calm water, air resistance is proportional to the square of ship velocity, and proportional to the cross sectional surface area of ship above the waterline. Normally, it equals to approximately 2% of total hull resistance, and may raise to 10% of total resistance for some special types of ship.

The air resistance [2] is defined as:

$$R_A = 0.9 \times \frac{1}{2} \times \rho_A v^2 \times A_A \tag{3}$$

Where R_A : Air resistance, ρ_A : air density, v : air speed, and A_A : cross-sectional surface area of ship above waterline.

2.4 Total hull resistance

The total hull resistance is experimentally determined as the below table 1:

Table 1: Percentage of ship’s total hull resistance

| Resistance type | % of total hull resistance R_T |
|-------------------------------|----------------------------------|
| R_F : Frictional resistance | 45 – 90% |
| R_R : Residual resistance | 45 – 8% |
| R_A : Air resistance | 10 – 2% |

2.5 Ship resistance change during operation

From the above analysis, and in this study range, the residual resistance and air resistance are nearly not changed during time of ship operation. The main factor causing the change of hull resistance after an interval of operation is only frictional resistance R_F . When a ship has berthed for long time, under the effect of sea creatures and seaweed on the external shells, the frictional resistance will increase from 25% to 50% in comparison with the initial resistance.

The ship’s hull resistance goes up by time from undry-dock, which the resistance is minimum due to new clean surface of hull without corrosion or scratch. Then, the frictional resistance of ship’s hull will increase under the effect of sea water environment depending on the time of operation and berthing period. As the result from the calculation and analysis, the change rate of hull resistance in a 6 months interval will go up from 10% to 20% [2] in comparison with initial undry-dock resistance depending on the ship’s operation time and draught.

Figure 3 describes the change of resistance characteristic of ship's hull after 6 months of undry-dock of ships with basic particular: 5m in width, 178m in length, 11,700 DWT, wet area: 3,650 m².

From the characteristic curves (Figure 3), the hull resistance changes by time of operation due to the increasing of frictional resistance, and at rate of 10% to 20% in comparison with the initial value after undry-dock.

The residual resistance and air resistance will change with amplitude depending on the effect of wave and wind. From table 1, the total of both these resistances may go up to 55% of the total resistance in some special situations (Figure 3).

It's found that the increasing of hull resistance by time of operation will make the thrust power raising significantly if the ship's speed is still kept constant. This requires the engine power raising accordingly to the increasing of hull resistance. Consequently, the engine power will increase, the exhaust gas volume from engine also raises, and requires a larger volume of inlet air. This is the reason why the changing of hull resistance will affect on the working condition of main engine turbo charger.

3. Supercharging by exhaust gas turbocharger, and load diagram of marine diesel engines

Turbocharger is a complete equipment installed in the diesel engine, which uses the exhaust gas energy outlet from the engine combustion to power a turbine shaft, driving a compressor wheel to push more air into the engine. Turbocharger makes the power and thermal efficiency of engine increasing (Figure 4). To clearly understand the importance of turbocharger for engine, in this part, we will study the description of an exhaust gas turbocharger system and the load diagram of FPP propulsion engine.

3.1 Arrangement of an exhaust gas turbocharger

Figure 4 shows the basic principle system of turbocharger [3], [6], including two main parts:

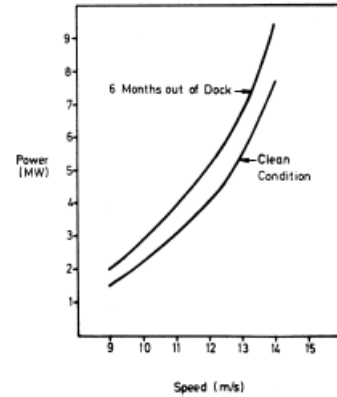

Figure 3. Change on ship's hull resistance

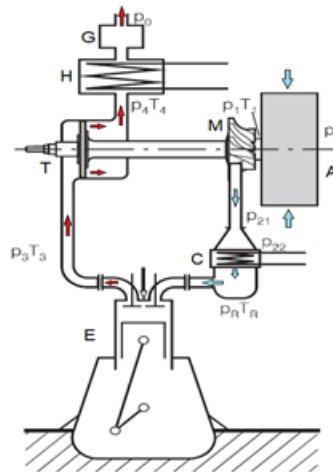

Figure 4. A diesel engine turbocharger arrangement

Where: P_0 : ambient air pressure; P_1, T_1 : air pressure and temperature before compressor; P_{21} : air pressure after compressor; P_{22} : cooler inlet air pressure; P_R, T_R : engine inlet air pressure and temperature; P_3, T_3 : engine outlet exhaust air pressure and temperature; P_4, T_4 : air pressure and temperature after turbine; A: silencer; M: compressor; C: air cooler; E: diesel engine; T: turbine; H: heat exchanger; G: exhaust muffler.

- Turbine part in the exhaust side of engine uses the exhaust gas energy to power the turbine shaft.
- Compressor part in the air inlet of engine is directly driven by the turbine shaft. Ambient air is drawn and compressed to desired pressure, and pushed into the air inlet.

To improve the engine efficiency, and reuse the exhaust gas energy, it is installed a heat exchanger on the passage of exhaust gas after turbine, and an air cooler in the air inlet after compressor to extend the air volume for engine. Furthermore, to enhance the efficiency and reliability of turbocharger unit, several auxiliary equipment are fitted such as silencer, heat insulating sheets, pressure gauges, and thermometers...

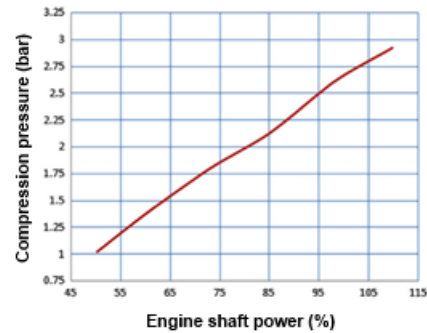

Figure 5. Compression pressure diagram

3.2 Load diagram and operation range of marine diesel engine

Compression pressure is important and effect on the quality of combustion. It raises linearly with engine power [4] (figure 5).

Engine load diagram describes the relation of engine moment, and power with speed. By experimental building, we can determine the basic engine parameters and operation ranges. Figure 6 shows the engine load diagram of a 2 stroke diesel engine with turbocharger.

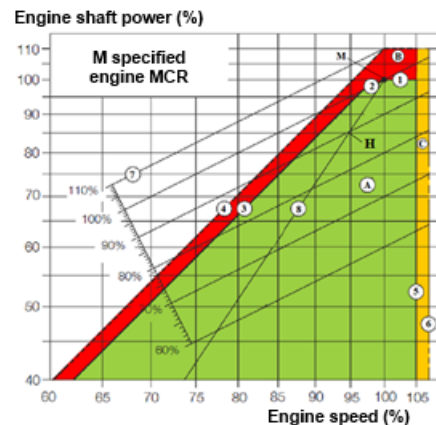

Figure 6. Engine load diagram

From the load diagram, the engine operation area is divided into 3 ranges: A, B, and C, in which A is the normal & safety service operation range. During the operation, engine should be controlled to work in point H with 85% MCR at 95% max rating engine speed. At this optimising point, the engine will run safety and reach high efficiency with minimum specific fuel oil consumption.

4. Effect of hull resistance on turbocharger operation

In fact, there may be different types of arrangement for propulsion a propeller shaft. In this study, it is considered for a 2 stroke low speed diesel engine directly driving propeller shaft.

Where: A. Normal engine load range, B. Overload limit range, C. Overspeed limit load range, M. Specified engine MCR point (Max continuous rating), H. Service operating point, Line 1. Specified engine MCR; Line 2. Torque through specified MCR; Line 3. Torque limit; Line 4. Overload limit; Line 5. Speed limit; Line 6. Overspeed limit; Line 7. Torque at 110% MCR; Line 8. Load limit through M specified MCR.

4.1 Ship propulsion system

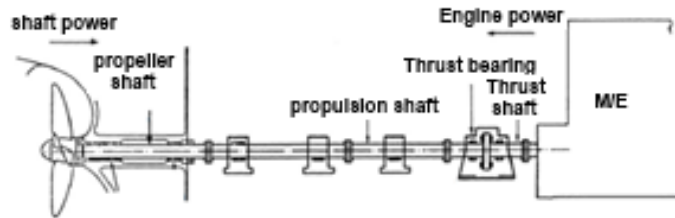

Figure 7. Ship propulsion system

As the driving model of propulsion system in figure 7, the rotating speed of engine will be same as propeller shaft, and engine power will be transmitted to the propeller shaft to force the ship. Energy loss due to friction at bearings, or sealing of propulsion system is quite low, and ignored. In this case, it's considered the shaft power is approximately equal to engine power.

4.2 Combination of engine and propeller

As the propulsion system in figure 7, we have the load diagram of engine with propeller in figure 8. From the graph, it's seen that the operating point of engine with propeller is the intersection between propeller curve and load curve (point M, N and I). As the hull resistance increases, the propeller curve tends to shift to the left, but the load curve is still constant, so the operating point will move to the left, cause the engine power and speed reducing, and consequently the speed of vessel goes down. If the operator still keeps the speed of vessel, it will make the engine overload partially, and exhaust gas temperature highly increases (fig.8).

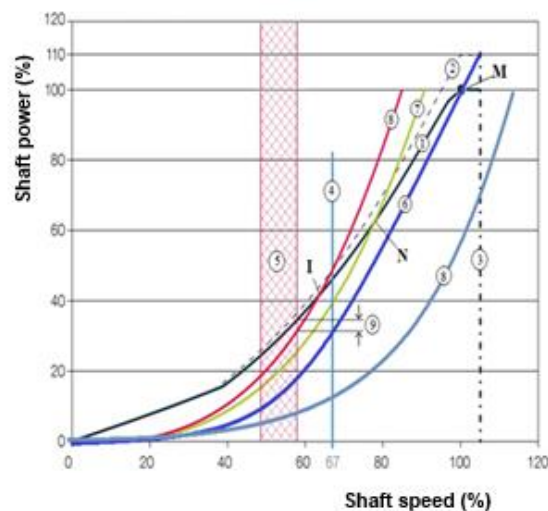

Figure 8. Combination between engine and propeller shaft

Where: 1. Load limit, 2. Overload limit, 3. Speed limit, 4. Speed limit at 50% MCR, 5. Resonant speed range, 6. Initial full load propeller curve, 7. Heavy load, resistance propeller curve, 8. Trial propeller curve, 9. Power reserved range for resonant speed, M – MCR working point, N, I – working points of engine with propeller.

4.2 Turbocharger characteristics and efficiency working area.

In order to analysis the effect of hull resistance on the turbocharger operation, we should study compressor map, and the peak efficiency area of turbocharger.

Figure 9 describes the compressor map of an ABB turbocharger, series VTR304P [3]. The operating point of turbocharger is the intersection point N between the engine performance curve and turbocharger curve. At this point, the turbocharger works stably (on the right side of stable limit curve) with the highest efficiency of approximately $\eta = 0.81\%$, and the speed of compressor reaches approximately 90% service speed of turbocharger. It's very important to determine the operating point of turbocharger. This point must be as close as the peak efficiency curve of compressor to optimise the power capacity of engine.

In the first trials on engine with turbocharger, the parameters will be recorded to analysis and determine the optimising point. If the operating point is not correct, consequently the compression pressure will be too high or low, or drop in the unstable area in the right of compressor surge line. To select the operating point of turbocharger, it is necessary to adjust the outlet air guide, or change the throat area or size of nozzle ring.

As the operating point drops in the low efficiency area with low speed of turbine, it causes compression pressure decreased, consequently the engine can not reach the optimum of turbocharger. Less compression air, the combustion will be worse, and the engine power will be reduced.

4.3 Effect of hull resistance on the turbocharger operation

From the above analysis, the ship's hull resistance will increase by operating time and maintenance interval. As resistance arising, the operating point of engine with propeller will change. It will shift to the left side, from point M to point N or I. At point N or I, the engine speed decreases significantly 20% to 30% of continuous rating speed. Referring to the resonant speed, it needs to reduce the speed lower resonant range, at 50% below the continuous rating speed. This causes the ship's speed far slow down in comparison with the design speed. Moreover, changing the engine working condition once hull resistance arising will affect on the turbocharger operation as below:

- As hull resistance arising, engine condition is changed to new condition with low power and speed. From figure 5, compressor pressure will decrease, turbine service speed drops,

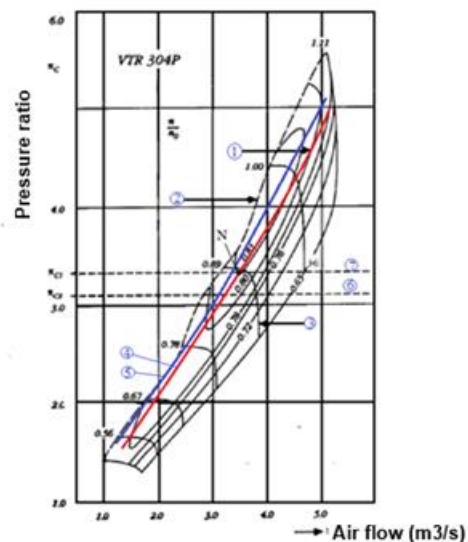

Figure 9. Compressor map

Where: 1. Peak efficiency line, 2. Surge line, 3. Turbine speed curve, 4,5. Engine performance curves, 6,7 compressor efficiency curves.

exhaust outlet resistance increases, the combustion will delay through the exhaust stroke. Consequently, the efficiency of engine and turbocharger reduces.

- Beside that, as the hull resistance increases, the engine may drop in the partial overload area with high exhaust temperature. Under this condition, the turbine inlet gas temperature will raise excessively, and may cause damage on nozzle ring, and turbine blades, even cracked, or burned [5], (figure 10).

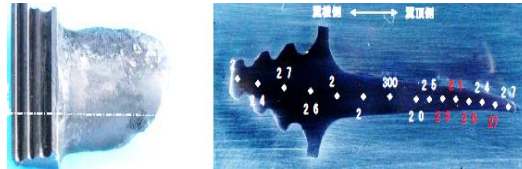

Figure 10. Excessive heat causing damage on blade profile part.

- Hull resistance rising also makes the engine condition overloaded partially, consequently speed of engine and turbocharger reduced. From the compressor map in figure 9, the operating point N of turbocharger tends moving to the left, drops in the surge margin, and causes turbocharger unstable in operation. If running under this condition for long time, the energy balance will be broken out, and causes rotor unbalanced. Consequently, the turbocharger may be damaged during operation.

5. Conclusion

The resistance raising by operating time will affect not only on the working condition of engine, but also turbocharger.

Increasing hull resistance will lead the effect on the operating characteristics of turbocharger such as: the efficiency of engine and turbocharger reduces; engine is partially overloaded which makes exhaust gas temperature increase excessively, then causes damage or bent on nozzle ring, and turbine blades, consequently turbocharger is damaged. Moreover, hull resistance raising will cause the turbocharger working unstably, unbalanced, and other parts damaged.

During designing, installing and operating of turbocharger on main engine driving propeller shaft, it is necessary to highly pay attention to the changing of hull resistance effected on the working condition of turbocharger to reach the optimising selection, installation and operation.

Reference

- [1] Kees Kuiken, "Diesel Engine II for ship propulsion and Power plans", Target Global Energy Training Noorderhooijdijk 29755 PJ ONNEN The Netherlands, pp 40, (2008).
- [2] KJ Rawson, EC Tupper, "Basic ship theory" Butterworth Heinemann, ISBN 02750653973, Chapter 10 pp: 381 – 395, (2001).
- [3] V. Quan Phan, T. Phuoc Ho "The phenomenon surging of turbocharger compressor of marine diesel engine" The transport Journal (2011).
- [4] M. Morsy El Gohary, Khaled M. Abdou, "Alexandria Engineering Journal", Alexandria Engineering Journal 50, 1–11, (2011).
- [5] Training Course of MET turbocharger – Mitsubishi, (2016).
- [6] Hermann Hiereth, Peter Prenninger, "Charging The Internal Combustion Engine Power Train" Springer Wien New York (2003).

SEA TRAFFIC MANAGEMENT AND THE SMART MARITIME COMMUNITY

Sergio Velasquez Correa*, Xavier Martinez de Oses* and Ulf Siwe† Barcelona School of
*Nautical Studies (FNB/UPC-BarcelonaTech) Universitat Politècnica de Catalunya –
BarcelonaTech Pla de Plau, 18, 08003 Barcelona, Spain e-mail: svelasquez@cen.upc.edu,
fmartinez@cen.upc.edu web page: <http://www.dcen.upc.edu>

† Swedish Maritime Administration (SJÖFARTSVERKET) SE-601 78 Norrköping, Sweden e-
mail: E-mail: ulf.siwe@sjofartsverket.se web page: <http://www.sjofartsverket.se/en/>

Keywords: Sea Traffic Management, European Maritime Simulators Network (EMSN), Port CDM, SeaSWIM

ABSTRACT

Sea Traffic Management is a concept developed during the last six years creating the culture of sharing information and collaborating to optimise the maritime transport and extending the benefits to the logistics chain and at the same time, enhancing maritime safety and environment. The project takes advantage of the several technology and equipment now installed on-board ships, improved by the use of information and communication technologies and the need of standardization procedures and protocols in the transport sectors. Few complementary tools introducing the use of VDES (VHF Data Exchange System) will make possible a radio communication system that operates between ships, shore stations and satellites on Automatic Identification System (AIS), Application Specific Messages (ASM) and VHF Data Exchange (VDE) frequencies in the Marine Mobile VHF band. With the available data, communication channels and infrastructures, the digital information on-board and on shore is abundant; however, the interconnection today is point-to-point and proprietary and stops the industry becoming more efficient. We will discuss how Sea Traffic Management will help the industry achieve improved predictability by introducing standards for key information and supplying an infrastructure for information exchange. This enables all actors involved in the transport to plan better and utilise their resources more efficiently. Shorter routes, just-in-time arrivals, shorter port calls are factors that will strengthen the competitiveness of the maritime sector. Improved situational awareness on the bridge and knowledge of planned routes will help optimised planning as well as reducing the number of incidents and accidents. The standard route exchange format submitted by the EU-financed MONALISA 2.0 project partners in 2014 is included in the current edition of the IEC standard, which was launched in August 2015. Ship operators, savings on fuel and other cost, society saves on reduced emissions, and other actors associated to maritime operations benefit from a higher degree of infrastructural use. This paper explains the progress and preliminary results of the key enablers of STM Validation Project and the steps beyond the current EU funding support that must complete a promising picture of next decade maritime transport industry.

INTRODUCTION

The recent past of maritime navigation has been focused on the skills of the bridge and engine officers on board. During the last years of the past century and the first decade of century XXI, the manoeuvring, safety and security of ships have evolved on different equipment and systems designed to support, aid and contribute to the own navigation tasks. The RADAR, ARPA, GPS, AIS and ECDIS have represented an evolution on the tasks of watch-keeping and decision-making processes during the navigation stages. The improvements on safety and the reduction on

maritime accidents are a good signal about the synergy between human – machine interaction. The four main navigation problems that seafarers must solve during the sea navigation,

- to establish the position (in terms of latitude and longitude),
- to establish the heading (with reference to geographic north),
- to establish the time, speed and distance during the trip and
- to know the hydrography, meteorology and state of the sea during its navigation,

are now simplified with basic functions pressing some buttons or giving instructions through computer screens. This can be thought as first technological revolution in maritime industry after the invention of chronographer. Nevertheless, the shipping industry is currently passing through probably the most important change it has seen in the last two hundred years, “digitalization”. The conjunction of sea transportation, port activities and logistics synchronization, have shown one or two milestones in the development of the industry, not least the move from wood to steel hulls and from sail to steam. However, the most recent innovations, which are forcing all mariners to re-think on basic bridge functions, are the advances of electronic navigation systems and the introduction of internet. Watch keeping operations are constantly changing with enforced simplified bridge systems. Officers are being given additional tasks to carry out (e.g. communications) while some of the older operations (like chart correction, as known) have changed becoming obsolete. Information and communication technologies (ICT) are here to stay and go on, beyond the integrated bridges, where Internet of the Things (IoT), 5G communication technology and big data analysis have become the dominant issues in the maritime domain to improve safety reducing the number of accidents, reduce fuel consumption, minimize environmental damages and optimizing routes and port calls. E-navigation promoted by IMO and EU e-maritime initiative boosted by European Commission have become in the drivers to think in global solutions involving maritime transport, port operations and logistics because the current need to know, share and exchanged information. Sea Traffic Management Validation Project Sea Traffic Management project (STM), sequel of former MONALISA and MONALISA 2.0 projects is one of the wider and ambitious projects to implement the electronic and digital management of the global transport chain. Motorways of the Sea is the flagship project of Europe and requires of instruments like STM to create a common maritime arena, similar to the Air Traffic Management programme SESAR. This ambitious project is lead by the Swedish Maritime Administration, composed by 13 EU Member States, more than 70 companies and organizations, public and private academia and funded by the European Commission through Connecting Europe Facilities budget approved by the Innovation and Network Executive Agency (INEA). The project has been broken down in four key enablers: • Voyage Management services will provide support to individual ships in both the planning process and during a voyage, including route planning, route exchange, and route optimisation services. • Flow Management services will support both onshore organisations and ships in optimising overall traffic flow through areas of dense traffic and areas with particular navigational challenges. • Port Collaborative Decision Making (Port CDM) services will increase the efficiency of port calls for all stakeholders through improved information sharing, situational awareness, optimised processes, and collaborative decision making during port calls. • SeaSWIM (System Wide Information Management) will facilitate data sharing using a common information environment and structure (e.g. the Maritime Connectivity Platform). This ensures interoperability of STM and other services. In addition to the digitalization of the maritime industry, it is important to mention that no technological advances can be optimally employed without proper training. The proliferation of systems and information on board is aimed to support crew in their watchkeeping tasks during voyages by avoiding hazards earlier and more clearly. They way how crews must adopt new standards and manage huge amounts of information (big data) at screens must be learnt by updating knowledge through training. New competences related to the actors involved in STM at shore side, on board and for

operational safety, is a part of the analysis of the project, in order to know future competence requirements regarding the new scenarios coming from the implementation of STM services, with the resulting variations in operational techniques and procedures. The internal and external project stakeholders, the clusters and the international forums need to be consulted in order to provide suitable answers promoting the engagement of skilled and qualified professionals and staff into the maritime and port industries in the coming years when STM will be deployed.

1. Current shipping market situation

Thanks to globalisation, global trade has experienced an accelerated growth between 2000 and 2008 producing a huge impact on the demand of shipping as the mass transportation mode worldwide (Figure 1). In parallel and not since the event of industrialisation in XIX century has there been a technological significant change as enormous as digitalisation already is nowadays and in the near future is expected to be. Even information systems have represented a third industrial revolution since the end of 70's in XX century, new generations are living for the first time a new change in the technology development based on information and communication infrastructures. Big Data can be collected on the go by several devices, stored and exchanged on the “cloud”, processed in real time and smartly connected. This progress allows for a whole new quality in communication, connectivity and ultimately also in production, in transport and logistics. The digital possibilities of connectivity mean that time and space are being completely computed/predicted simultaneously, “contradicting” Heisenberg's uncertainty principle¹. In terms of economical parameters, this is linked to a reallocation of resources, which will entail a massive shift in production, trade and logistics. These developments and changes have to impact on shipping industry in different ways, as it will be discussed further.

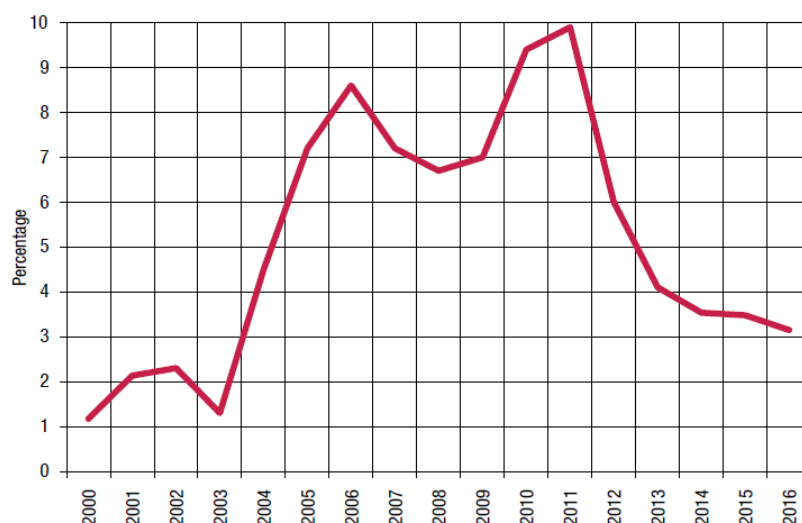

Figure 1. Annual growth of world fleet, 2000–2016 (Percentage annual change). Source: UNCTAD, Review of Maritime Transport, various issues.

The new technological solutions to process Big Data and connect them smartly has inspired a group of experienced shipping officers in Scandinavia to apply such technology into the maritime field. The most important of these solutions from shipping industry perspective has been:

- Digital platforms,
- Big data analysis,

¹ The authors allow themselves the freedom to paraphrase this principle of quantum mechanics: Introduced first in 1927, by the German physicist Werner Heisenberg, this principle states that the more precisely the position of some particle is determined, the less precisely its momentum can be known, and vice versa.

- Maritime cloud,
- Use of simulators in networks
- Artificial Intelligence,
- Internet of Things,
- Blockchain,

Since the STM concept started to be a reality, many of these digital innovations have played a major role for shipping looking at the future, both directly and indirectly. Because trade, transport and logistics are dependent variables, developments and changes in shipping have to play at least as important a role as the direct changes in processes and business models within the shipping industry including maritime ports. These are the key pillars of STM Validation Project, the way in which technology will improve shipping industry, maritime transport, logistics and international trade operations smartly under collaboration philosophy among parties.

2. The Context of STM Validation Project

In 2010, the European Union (EU) commenced a multi-year project to fund innovation in the shipping industry to improve efficiency, safety, and sustainability, goals which parallel the triple bottom line of profits, people, and planet [1]. The initial project, MONALISA 1.0, concentrated on increasing ship-to-ship collaboration through sharing routes among ships and shore-based vessel management authorities. The project operated in the Baltic Sea Region. This project was then extended, MONALISA 2.0 (2013-2015), to cover more regions in Europe with more partners and an increased budget. The focus, inspired by the Single European Sky Air Traffic Management Research (SESAR) project, was to enhance Sea Traffic Management (STM) by applying three concepts (voyage management, flow management, and port collaborative decision-making) supported by a digital data-sharing infrastructure. In 2015, the project was renamed STM validation and the consortia was granted €43 million to validate STM concepts in 13 ports with over 300 participating ships.

The EU sees acceleration of the industry's digitization as critical to meeting its goals² and it expects STM to revolutionize the shipping business.

3. Collaboration in shipping and global trade requires data sharing

In the maritime sector, as with nearly all industries related, no one can act independently. Sea transport is dependent on multiple players' contributions to the value network. Ecosystems should be efficient in all their parts because there is a need for each organization to base its planning on the actions and intentions of the others. This means that to improve operational performance data needs to be shared among involved organizations within the ecosystem and merged with each organization's data. Data sharing for collaborative decision-making is at the core of the Sea Traffic Management (STM) enabler Port Collaborative Decision Making (Port CDM) in which two message formats are promoted; the route exchange format and the port call message format.

Within the STM validation project, 13 ports are engaged in validating Port CDM where there have been concerns raised for what would happen with the data that a single organization might share. Port CDM aims at improving situational awareness through data sharing based on the port call message format. Hence, it is vital that all actors contribute with relevant data to a port's system of records to support mutually beneficial port planning [2]. A port is a meta system of production composed of independent, yet interdependent, systems of production linked through

² The digital transformation of EU business and society. EU Growth Initiative: Internal market, industry, entrepreneurship and SMEs. 2018.

a ship's sequence of episodic tight couplings. To optimize this meta system, we need a meta system of records to enable a holistic analysis to improve a port's competitiveness.

By the other hand, Sea Traffic Management takes a holistic approach to services making the berth-to-berth ship voyage efficient, safe, and environmentally sustainable. Hence, STM puts the voyage in focus and uses that as a core element for enhanced safety, optimised processes for involved actors and stakeholder interaction.

In order to define STM, focus is put on user needs and a holistic view of the voyage is achieved by using legal/institutional; operational; information; and technical perspectives. STM requires enhanced interaction between ship-to-ship, ship-to-shore, shore-to-ship, shore-to-shore enabled by information sharing empowered by enhanced service interaction. In summary:

STM is a concept building on services made for sharing secure, relevant and timely maritime information between authorised service providers and users, enabled by a common framework and standards for information and access management, and interoperable services

The scope of STM includes private, mandatory, and public service opportunities along the whole voyage from berth-to-berth. Further, STM relates to existing practices and on-going initiatives within IMO's e-navigation Strategy Implementation Plan, e-maritime, and the collaborative port. STM complements and adds to existing/on-going initiatives. STM includes concepts for Strategic and Dynamic Voyage Management (DVM), Flow Management (FM), Port Collaborative Decision-Making (Port CDM), enabled by distributed and service based information management; a maritime service infrastructure [3].

4. Basic principles of Sea Traffic Management

To achieve these benefits, a service-based and regulated information sharing framework is required. The basic logic behind STM builds upon the following principles:

- 4.1. A voyage is defined and all its attributes are connected through a unique voyage identifier;
- 4.2. Information related to the voyage, and thus basis for sharing, is connected via the voyage identifier;
- 4.3. Operational intentions of sea- and land based actors are provided to others well in advance and kept up to date;
- 4.4. ICT services supporting personal contacts;
- 4.5. A collaborative attitude is empowered in information sharing and decision making;
- 4.6. One single point of reporting;
- 4.7. Situational awareness is derived from multiple informational sources;
- 4.8. Secure and authorised service realisation; and
- 4.9. Discovery and distribution of services are realised through an infrastructure governed by a Federation/Organisation.

Further, the following prerequisites are used in the STM definition:

- The Master is in command;
- United Nations Convention on the Law of the Sea (UNCLOS) and the Convention on the International Regulations for Preventing Collisions at Sea (COLREG) are complied with;
- Existing systems and on-going initiatives are considered; and
- Information ownership is managed by a secure system of access control and authentication.

STM is a framework, harmonisation of data formats and standards for information management and operational services. Some of the standards enabling STM are:

- route exchange format;
- port call message format;
- other text message format;
- time stamp definitions;
- service specification language;
- geospatial and location data standards;
- processes for approval, distribution, and discovery of services;
- processes for federated governance of service portfolio; and
- access management.

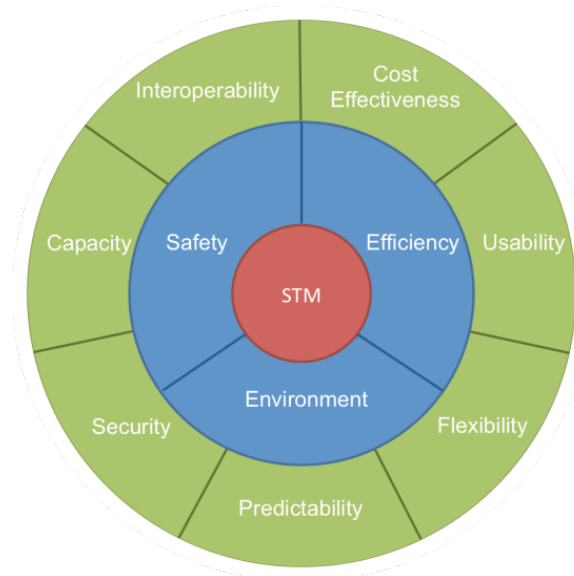

Figure 2. Sea Traffic Management’s main and subordinate objectives. Source: STM Project Technical documents

5. Milestones up to now with STM Project

In the final stretch of the STM project, the installation of the necessary systems on land and on board ships has been achieved. The work in the simulators using the European Maritime Simulators Network (EMSN) has managed to validate many of the proposed services for the exchange of routes and the exchange of information with the shore centres. Some of the milestones achieved and that will be presented at the IMO at the final conference in November in London on 13th November 2018 are:

- May 2018, Ramira vessel departed Gothenburg and shared her voyage plan with destination port Rotterdam. The receipt of the voyage plan's ETA was confirmed by Rotterdam's Pronto system via a text message back to Ramira. Thereby, the first live port call synchronization in the STM history took place.

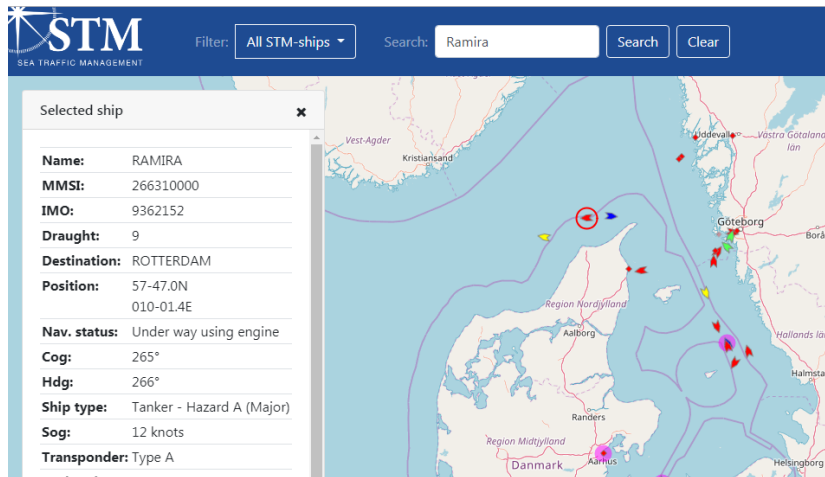

Figure 3. Ramira vessel sharing her voyage plan with the port of destination. Source: STM Project Technical documents

- June 2018, Kongsberg installed their STM capable C-Scope VTS software in Horten, Kvitsøy and Tarifa - Spain and the systems were used for live Exchange of voyage plans. Ships from Costa (partner of the project) and MSC (with many ships equipped for STM project) are now sharing real data from the first ships via the Neptune Fleet Operations system. This is a clear showcase for how proprietary platforms like fleet operations can be connected to other systems via STM standards and infrastructure.

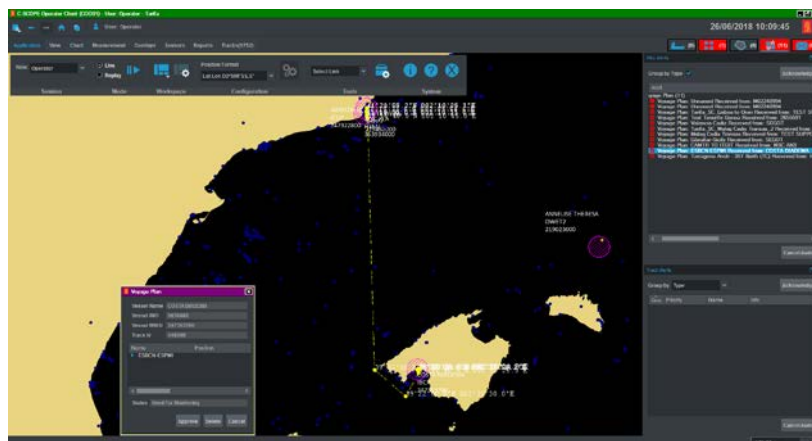

Figure 4. Screenshots from ships that have shared their voyage plans that passes in the area of the Shore Center in Tarifa. Source: STM Project Technical documents

6. Conclusions

In the distributed world of maritime transportation, different actors have taken up digitisation in the way that it serves them best. Typically, big actors have created systems for coordinating their transport operations. They do however rely on other actors' ability to become more efficient because of the complex scheme of international trade. To overcome this situation, Sea Traffic Management has been proposed in which intentions of upcoming, and the accomplishment of actions are communicated prior to and during a sea voyage. STM puts an emphasis on interoperable and harmonised systems allowing a ship to operate in a safe and efficient manner while also lowering its carbon footprint.

Maritime operations build upon the interplay between three types of core actors; shipping companies, ports, and cargo owners. This is an inseparable trinity meaning that neither of them exists without the other. Connected to this trinity there are numerous coordinators (such as the shipping agent) and service providers (such as tug operators) enabling efficient operations.

STM is based on the premise that the data owner decides on who shall be able to access the data it provides. By regarding the port as a hub, this would mean that the data provider authorizes access to all actors within the port. This would enrich situational awareness for a port's actors and enable a port to operate as an efficient system of production. Limited sharing of data restricts PortCDM to a system of engagement, which means that actors only share intentions to enable episodic coupling among each other, but a port perspective would enable integrated coupling across a port visit.

STM project is now representing a step forward in the natural shipping industry evolution as part of three milestones reached in shipping and navigation:

- RADAR – You could see that something is near or close to you, or on the route you are following
- AIS – In this stage you knew who is near to you, the name of the ship, the type of vessel, its position shown on an electronic chart, its course and speed
- STM – Now you know about the plans, situation and behaviour (navigation intentions of the other)

For more information, visit STM Validation Project website: <http://stmvalidation.eu/>

7. References

- [1] Elkington, J., *Cannibals with forks. The triple bottom line of 21st century.* 1997, Oxford: Capstone.
- [2] Lind M., Bergmann M., Haraldson S., Watson R.T., Park J., Gimenez J., Andersen T. (2018) *The skilled collaborators - the winners in a digitized maritime sector*, STM Validation Project.
- [3] Mikael Lind, Mikael Häggb, Ulf Siwec, Sandra Haraldsona. *Sea Traffic Management – Beneficial for all Maritime Stakeholders.* Proceedings of 6th Transport Research Arena, April 18-21, 2016, Warsaw, Poland.
- [4] Adner R. (2006) *Match Your Innovation Strategy to Your Innovation Ecosystem*, Harvard Business Review
- [5] Andersen & Schellhorn (2015). *Business case analysis report*
- [6] Andersson, P., Ivehammar, P. (2014). *Economic Impacts - Cost Benefit Analysis of Implementing Dynamic Route Planning at Sea.* Norrköping, Sweden: MONALISA Project Bureau.
- [7] Elkington, J., (1998). *Cannibals with Forks: the Triple Bottom Line of 21st Century Business.* New Society Publishers
- [8] Haraldson S. (2015) *Digitalization of Sea Transports – Enabling Sustainable Multi-Modal Transports*, Twenty-first Americas Conference on Information Systems, Puerto Rico
- [9] IMO. (2013). *A concept of sustainable maritime transportation system.* Retrieved 2014-08-30
- [10] Osterwalder, A., & Pigneur, Y. (2011) *Business Model Generation: Ein Handbuch für Visionäre, Spielveränderer und Herausforderer.* Campus Verlag.

- [11] Södahl, B, Hanning, A., Hult, C., Garne, K., Hindrum, K. (2013). Svallvåg 2013 - Svensk maritim forsknings- och innovationsagenda. Gothenburg, Sweden: Chalmers University of Technology.
- [12] Stankiewicz, M., Backer, H., Vlasov, N. (2010). Maritime Activities in the Baltic Sea – An integrated thematic assessment on maritime activities and response to pollution at sea in the Baltic Sea Region Baltic Sea Environment Proceedings. Helsinki, Finland: Helsinki Commission.
- [13] Target Concept. (2015) MONALISA 2.0 Project, Activity 2 – Defining Sea Traffic Management, “The Target Concept”, Document No: MONALISA 2 0_D2.3.1.

**HUNTS POINT TERMINAL MARKET:
THE DEMAND FOR WATERBORNE TRANSPORTATION
AS A PART OF THE OUTBOUND DISTRIBUTION SYSTEM***

SHMUEL YAHALOM^{*}, CHANGQIAN GUAN[§], ERIC JOHANSSON^{}, AND
CAMILLE KAMGA[†]**

^{*} Department of International Trade and Transportation
State University of New York Maritime College
6 Pennyfield Avenue, Throggs Neck, New York 10465
E-mail: yahaloms@aol.com, syahalom@sunymaritime.edu

[§] Department of Marine Transportation
United States Merchant Marine Academy
300 Steamboat Road, Kings Point, New York 11024
E-mail: cguan68@gmail.com

^{**} Department of Professional Education and Training
State University of New York Maritime College
6 Pennyfield Avenue, Throggs Neck, New York 10465
E-mail: safemariner@me.com

[†] Department of Civil Engineering
City College of the City University of New York
New York City, New York, 10031
E-mail: ckamga@utrc2.org

Keywords: Hunts Point Terminal Market, Waterborne Distribution, Produce, Waterborne, Waterway, Congestion

Abstract

The goal of the study is to explore an alternative to the primary use of trucks for outbound delivery or pick-up of food products in the Metropolitan area from Hunts Point Terminal Market (HPTM). *The alternative proposed is the use of waterborne transportation (barges or freight ferries); as part of the outbound food distribution system. The study's objective is to quantify the potential demand for waterborne services from which vehicle mile savings is determined.* The waterborne

* This project was funded by New York State Energy Research and Development Authority (NYSERDA) and the University Transportation Research Center (UTRC). NYSERDA Report 07-10, June 2017.

vessel will be loaded with food products at HPTM and moved (self-propelled or pulled) to a strategically located predetermined site in the Metropolitan area. Retailers will pick up their preordered food products from this site, and the process starts all over again.

1. BACKGROUND

New York City's (NYC) roads and highways are congested, partly due to trucks delivering food products to/from Hunts Point Terminal Market (HPTM) located at the Hunts Point Peninsula. HPTM is the largest fresh food distribution center in the United States (U.S.), the source of 60% of the food distribution in the New York Metropolitan Area (NYMA). The daily food delivery in the NYMA is primarily via HPTM with 15,000 [1] truck moves of which 12,000 are outbound. These trucks increase traffic congestion, pollution, and wear-and-tear on the roads, which increases the cost of living in the City, commute time, medical problems and costs, and reduce' productivity.

Waterborne operation as part of the food distribution system reduces the number of truck trips and mile driven. These reductions reduce the demand for fuel, pollution and congestion. A waterborne distribution system could provide new opportunities, such as offsite distribution centers for outbound and inbound movement.

The goal of the research is to explore a waterborne transportation alternative to the primary use of trucks for outbound delivery of food products from HPTM in the NYMA (barges or freight ferries). The study quantifies the potential demand for waterborne services from which vehicle mile savings is determined. After the literature review and research methodology, the paper describes the food distribution system in the NYMA, HPTM's role, the benefits and challenges.

2. LITERATURE REVIEW

The literature review addresses wholesale produce distribution and the role of HPTM, which is almost exclusively by surface transportation. In general, the wholesale distribution system complies with storage and distribution requirements. Thompson and Kader [2] describe the factors for storage and transport of produce. Rogoff [3] addresses the importance of logistics and supply chain in food distribution for financial profitability. In a freight ferry study, de Cerreño, et.al, [4] "explores the feasibility of freight ferries as a potential intra-regional waterborne alternative for truck freight movements across the Hudson River/NY Harbor." DiNapoli [5] addresses the economic impact of HPTM on the food distribution. Freight rates are raised by NYCEDC [6], HPTM [1] provides some basic statistics of the facility, New York City Department of Housing and Development [7] discusses the land use of Hunts Point peninsula and future plans, Tarleton [8] addresses the future of HPTM, and Zalman [9] talks about the perishable business.

The NYC Plan for the next 30 years highlights the role of HPTM in the food supply [10] indicating that "Approximately 95% of the city's food travels into NYC by truck, via a limited number of access points (mainly bridges). ..., nearly 30% of the truck traffic over the George Washington Bridge on any given day..." [10]. HPTM serves the intermediate and small stores via direct buying and/or direct outbound distribution. The literature review indicated that there was no study of outbound food distribution for HPTM.

3. RESEARCH METHODOLOGY

The research methodology was of data collection and analysis via survey and interviews. The

statistical analysis provided an estimated demand of services by zip code, which was the foundation for food distribution to the NYMA for direct and indirect impact of a waterborne delivery on the region. The amount of data collected indicates 95% confidence level or better.

4. FOOD DISTRIBUTION

Food consumption in the USA is about one ton per person [11]. NYC consumes more than 5.7 million tons of food annually [10]. The number of food establishments in NYC in 2014 (restaurants, bars and cafes) was 23,705 [12], of which 7,151 [13] were fast food. Food distribution takes a large amount of logistics and supply chain resources (Figure 1).

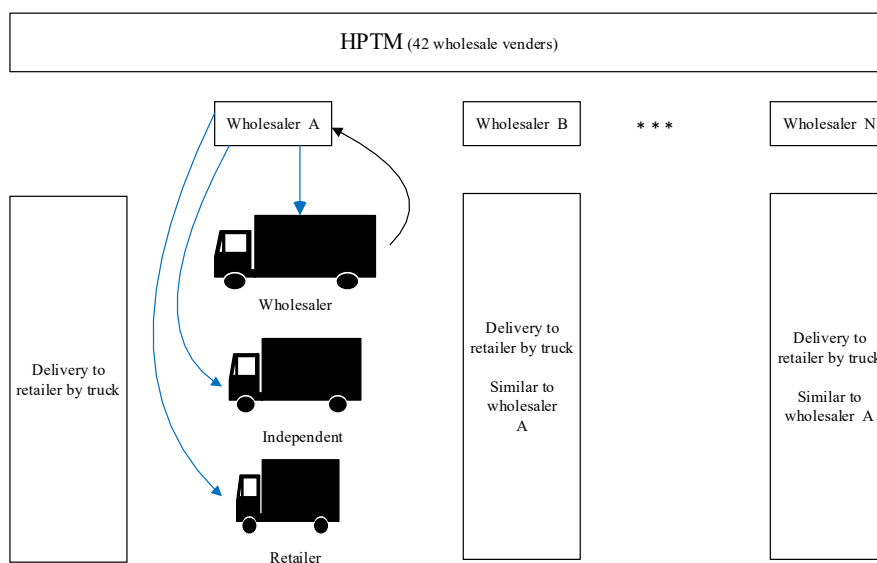

Figure 1: Contemporary Supply Chain Delivery

The outbound food wholesalers are: large, medium and small. Borderlines between the wholesalers' size categories are hard to identify due to lack of information. There are retailers who come directly to HPTM to purchase food products regularly.

- The large and intermediate wholesalers have in-house distribution facilities and own vehicles. Food products are shipped inbound directly to their distribution facilities mostly via surface transportation modes. The food products are shipped outbound from their own distribution facilities. Intermediate wholesalers, not located in HPTM, rely on HPTM to make up the differences for outbound distribution. The large firms supply at least 95% of the produce from their warehouse and use a facility such as HPTM, only in case they are short an item. Altogether, the HPTM wholesalers own about 100 trucks (boxcars and tractor-trailers), some of which are refrigerated.
- There are many small distribution firms or third party (3-P) brokers (at least 95%) that depend on HPTM to fill customers' orders. They might also visit large wholesalers.
- For an access fee of \$25 annually a small retailer visits HPTM for its own business. Small retailers do not use brokers; they prefer to See, Feel and Touch (SFT) the produce prior to purchasing. About 50% of the customers are SFT types.

5. RETAILERS DEMAND REQUIREMENTS AND SCHEDULING

The industry is **complex** and **competitive**. Its operation is dominated by wholesalers trying to accommodate the wishes of their customers (retailers) on-demand. A typical retailer: is small, following its own business model; has a limited amount of space, uses HPTM as its warehouse, places small orders at a high frequency (daily/twice a day/a few times a week); orders a mix of produce items at prime quality condition and lowest price; can reject produce at will; uses a 3-P broker delivery; is time sensitive; spot orders (no advance order).

Retailers are in command of the delivery schedule. The retailers expect on-demand and on-time delivery (2AM, 3AM, 6AM, 7AM or any time in between). There are retailers that require a second delivery in the PM hours as well. The delivery between wholesaler and retailer is carried out either by wholesaler, 3-P broker or the retailer itself.

Seventy to 80% of the retailers use a 3-P broker for ordering and/or delivering the produce. The retailer expects the 3-P broker to: check (SFT), buy, pick up and deliver the produce in good condition or it will be rejected and returned (5 to 10% of the time), deliver on time, and pay directly to the wholesaler unless other arrangements are made. Thus, for the 3-P broker to stay in business it must be fully accommodative and competitive.

6. HPTM Outbound Distribution

The total HPTM outbound produce distribution to six states is 210 million packages [1], an average of 67 packages/truck-trip/day for the 12,000 outbound truck-trips/day or 4.5 billion pounds [14] (an average of 22 packages/ pallet). The number of pallets of fruit and vegetables handled in a year is 9.6 million (6) (3.1 pallets/truck). Obviously, the outbound majority is in small parcels in small vehicles and not by pallet. Hence, an average of 40 packages/pallets is used.

The average number of outbound packages to 125 zip codes to New Jersey is 64.5% (Table 1). The weekly outbound average package distribution focus is on New York State (NYS) and its counties dominated by the Bronx (24%) (Table 2), due to its proximity to HPTM. Brooklyn had a 19% share and Queens 18%. The total outbound produce delivered to all NYC boroughs is 71%.

Table 1: Estimated Average Produce Outbound by Box Share and by Zip Code Distribution

| STATE | Weekly average number of packages | Relative share | Number of zip codes | Relative share | Relative share of vehicle trips by state |
|---------------|-----------------------------------|----------------|---------------------|----------------|------------------------------------------|
| Connecticut | 354,595 | 8.8% | 23 | 6% | 1,054 |
| Massachusetts | 146,193 | 3.6% | 11 | 3% | 434 |
| Maryland | 199,795 | 4.9% | 7 | 2% | 594 |
| New Jersey | 2,605,237 | 64.5% | 125 | 33% | 7,741 |
| New York | 681,496 | 16.9% | 200 | 52% | 2,025 |
| Pennsylvania | 51,144 | 1.3% | 15 | 4% | 152 |
| Totals | 4,038,462 | | 381 | | 12,000 |

7. CLUSTER DEVELOPMENT ANALYSIS

Using the HPTM outbound data, clusters by zip code east of the Hudson River (EH) were developed (excluding the Bronx) to determine potential waterfront sites for waterborne operation and the number of packages and truck trips (Table 2). There are a few operating waterfront landing

sites in Brooklyn that are ready to go (Navy Yard Basin, Red Hook, Atlantic Basin and Erie Basin). Other sites could be developed to accommodate a waterborne outbound distribution, including: Bowery Bay, Flushing Bay (120,702; 338 vehicles); Newtown Creek for Brooklyn and Queens; Manhattan (61,368 packages; 181 vehicle trips); Erie, Navy Yard, Red Hook and Atlantic Basins (132,619 packages; 373 vehicle trips); Westchester County (44,094 packages; 121 vehicle trips); Manhasset Bay or Hempstead for Nassau (73,094 packages; 198 vehicle trips) and/or Suffolk Counties (26,264 packages; 69 vehicle trips).

Table 2: Weekly Produce Package Distribution by NYS Counties

| County | Weekly average observed | % from NYS | Weekly average estimated* | % from NYC |
|------------------|-------------------------|------------|---------------------------|-------------|
| Albany | 8,278 | 4% | 26,398 | |
| Bronx | 50,309 | 24% | 160,433 | 33% |
| Brooklyn | 41,587 | 19% | 132,619 | 28% |
| Manhattan | 19,244 | 9% | 61,368 | 13% |
| Nassau | 22,921 | 11% | 73,094 | |
| Queens | 37,850 | 18% | 120,702 | 25% |
| Rockland | 7,353 | 3% | 23,448 | |
| Staten Island | 1,910 | 1% | 6,091 | 1% |
| Suffolk | 8,236 | 4% | 26,264 | |
| Westchester | 13,827 | 6% | 44,094 | |
| Other | 2,190 | 1% | 6,984 | |
| Total NYC | 150,900 | 71% | 481,214 | 100% |
| Total NYS | 213,705 | | 681,496 | |

*Estimate was extrapolated using 210 million packages a year reported before [1]

8. OUTBOUND TRUCK-TRIP ESTIMATES

Outbound distribution and vessel size from HPTM are derived from retailer order size, frequency of delivery, and location. Based on driver market survey ratio, 80% of outbound truck traffic from HPTM [7] or 12,000 outbound vehicle trips/day are distributed between six states (Table 1). The estimated distribution between three categories of vehicle sizes is as follows:

- The **boxcars** moved **50%** of the produce (trucks of 10ft to 28ft). Some are refrigerated.
- The **small vehicles** moved **31%** of the produce (vans, pickup trucks).
- The **tractor-trailer** truck moved **19%** of the produce (28ft to 53ft). Some are refrigerated.

The study focus is on NYS EH. Table 1 shows NY's relative share of vehicle trips for a total of 2,025 vehicles, of which 1,856 (Table 3, Column 2) travel from HPTM to EH counties and boroughs (15.5% of total truck trips).

A few scenarios are estimated to capture various possible distribution alternatives EH:

1. The outbound traffic from HPTM to the Bronx retailers is only by boxcar and van.
2. Outbound deliveries for long distances from HPTM are primarily by tractor-trailer.
3. Tractor-trailers come in different sizes; however, 40ft is used.
4. A tractor-trailer of 40ft can load 20 pallets or equivalent in packages (minimum of 16 pallets).
5. An average boxcar 20ft in size can load 10 pallets.
6. A van takes a maximum of 2 pallets (high load is 1.5 pallets). It is most likely loaded with an equivalent one pallet or less. Vans are frequently loaded with packages, not pallets.

Table 3: Estimated Outbound Vehicle Distribution for New York East of the Hudson River

| County/ Borough | % of NYS (1) | Relative share by county (2) | Tractor-trailer share (3) | Van share (4) | Boxcar share (5) |
|--------------------|-----------------|------------------------------------|---------------------------------|------------------|---------------------|
| | | | 19% | 31% | 50% |
| Bronx | 23.5% | 477 | 91 | 148 | 238 |
| Brooklyn | 19.5% | 394 | 75 | 122 | 197 |
| Manhattan | 9.0% | 182 | 35 | 57 | 91 |
| Nassau | 10.7% | 217 | 41 | 67 | 109 |
| Queens | 17.7% | 359 | 68 | 111 | 179 |
| Staten Island | 0.9% | 18 | 3 | 6 | 9 |
| Suffolk | 3.9% | 78 | 15 | 24 | 39 |
| Westchester | 6.5% | 131 | 25 | 41 | 66 |
| Totals | 91.7% | 1,856 | 262 | 428 | 690 |

Outbound distribution based on driver market survey is estimated daily EH (Table 3) from the data. For example, the number of van trips to Brooklyn at a van share of 31% is 122.

Vehicle trip distribution, assuming high density, is the average daily retailers' demand for produce (3,123 pallets of 40 packages/pallet). Applying the high-density assumptions (4, 5, & 6), the total potential daily number of vehicle trips needed is 878 (Table 4).

Modifying vehicle size trip distribution, the tractor-trailers' share in the delivery is in the “% of tractor-trailer” column with assumptions 5 and 6, based on interviews of 3-P brokers from HPTM. Table 4 shows vehicle sharing between the three vehicle types: 8 tractor-trailers carrying 128 pallets (16 pallets/truck), 1,182 pallets to 1,182 vans (1 pallet/van), and 604 boxcars carrying 1,813 pallets (3 pallets/boxcar) for a total of 1,794 vehicles (3,123 pallets).

In short, vehicle distribution to each county and borough EH provides alternatives with shortcomings. Scenario III with 3 pallets/boxcar is the most reliable with a total of 1,794 vehicles.

Table 4: Scenarios Summary

| County/ Borough | Scenario 1 (Table 3) | Scenario II | Scenario III | | | |
|--------------------|-------------------------|-------------|-----------------------------|-----------------------------|---------------------------|--------------------------------|
| | | | (3.5 pallets per boxcar) | % of tractor- trailer | (3 pallets per boxcar) | (2.5 pallets per boxcar) |
| Bronx | 477 | 225 | 474 | 0% | 496 | 527 |
| Brooklyn | 394 | 186 | 355 | 25% | 373 | 399 |
| Manhattan | 182 | 86 | 172 | 0% | 181 | 193 |
| Nassau | 217 | 103 | 189 | 46% | 198 | 212 |
| Queens | 359 | 170 | 321 | 28% | 338 | 362 |
| Staten Island | 18 | 9 | 17 | 0% | 18 | 19 |
| Suffolk | 78 | 37 | 65 | 64% | 69 | 73 |
| Westchester | 131 | 62 | 115 | 38% | 121 | 130 |
| Totals | 1,856 | 878 | 1,708 | | 1,794 | 1,915 |

9. WATERBORNE OPERATION: PROPOSED

Using a barge as an example, it is loaded at HPTM and hauled to a discharge site. After discharge the barge is hauled back to HPTM for the next round of operations (Figure 2). The

proposed operation model (Figure 2) requires that many wholesalers collaborate.

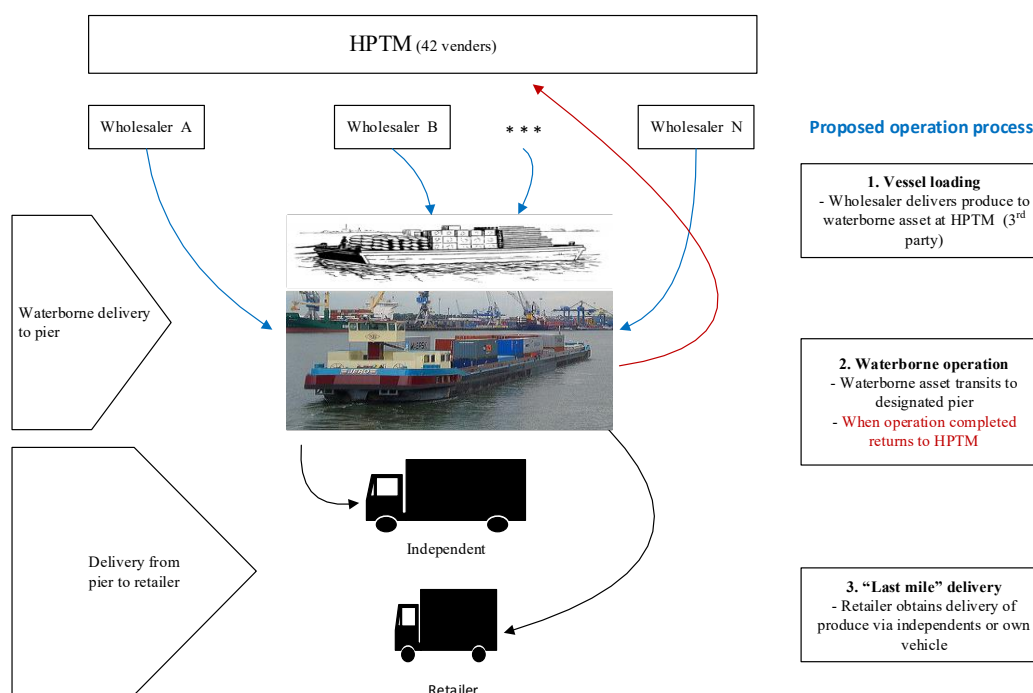

Figure 2: Proposed Supply Chain Operation.

10. GENERAL OUTLINE OF THE WATERBORNE OPERATION

For a waterborne operation to succeed, various issues need to be addressed, including: a dedicated party to load/discharge (HPTM vender or an independent); temperature required per product during loading and transit; products segregated as required; waterborne crew dedicated to the operation; waterborne asset duration scheduled for load/discharge; schedule for departure from and return to HPTM (including tugboat operator); transit time to discharge location, taking into account currents; maintenance schedule and contingency plans during maintenance; security awareness and security plan; training of crews (loading, discharge, and transit); contingency plans for various weather conditions (emergency, snow, storms, ice, etc.); chain of responsibility.

11. OUTBOUND WATERBORNE DISTRIBUTION SYSTEM AND CHALLENGES

Moving from a single wholesaler operation (Figure 1) to a shared operation (Figure 2) requires **consolidation** in the stowage plan which is driven by **segregation, temperature, and destination**. A waterborne operation should be economical providing **economies of scale** and reduce costs via a large system and wholesalers cooperation; thus, it will: reduce the number of trucks on the road, reduce the HPTM wholesalers' transport cost, and encourage wholesalers' participation in an outbound waterborne distribution.

Many of the present and waterborne distribution challenges (produce segregation, temperature control, timing of delivery, wholesalers working together, etc.) are the same. In addition, there are requirements of waterborne hardware and vessel design, new system supply chain management

(waterborne vessel loading priority and schedule, produce storage requirements, routing), landing sites' locations and designs, operations finance, community concerns, and others.

Wholesalers' support implies sharing delivery information, which is not the norm between HPTM wholesalers because of **distrust**. Trust needs to be established for an outbound waterborne delivery system to work. A "Third Party Waterborne Delivery Provider" (3PWDP) needs to be a part of the new operation. Thus, professional and impartial performance measures by the 3PWDP should be incorporated into the operation matrix, including:

- **Arbitration.** An arbitration system should follow a manual and protocol guideline and be available at the operation's start. A dispute automatically involves arbitration.
- **Transparency.** In the effort to reduce tension and business operation disruption, transparency is paramount and should be regularly reported by the 3PWDP.

12. OUTBOUND WATERBORNE RETAIL DELIVERY

The proposed waterborne distribution system (Figure 2) has a 3PWDP buffer, with strict schedules of each of the three parties along the supply chain. The wholesaler delivers the produce to the pier at HPTM on schedule. The 3PWDP would be required to a schedule of: (1) loading, (2) transiting to the discharge location, and (3) transiting back to HPTM. Finally, the retailer's pickup would be at a scheduled time at the pier.

A waterborne distribution system will reemphasize the "**last mile**", i.e., from the waterborne landing site to the retailer's business site. Developing friendly landing sites with community input is vital to minimize the Not-In-My-Back-Yard (NIMBY) resistance.

13. CONCLUSION AND RECOMMENDATIONS

An outbound waterborne distribution system benefits NYC in reducing traffic congestion, pollution, wear-and-tear of roads and bridges, the cost of living, commute time, and medical problems and costs (increase in productivity). Implementing an outbound waterborne distribution require stakeholders' (wholesalers, retailers, and government officials) cooperation and support.

Findings: A system which completely replaces the present system would have a net effect of:

- savings of 39,500 miles/day (10.3 million/year)
- emissions reduction of 37,300 pounds of carbon dioxide/day (9.7 million pounds/year)
- savings of 2,076 gallons/day (540,000 gallons/year and \$1.35 million at \$2.50 per gallon)
- time saving close to 1,500 hours/day or 390,000 hours/year or 260 working days

A fully implemented waterborne operation of moving 125,000 packages/day (3,123 pallets) would have a total of 1,280 vehicle trip savings/day.

The challenges to obtain a reliable outbound, waterborne operation system includes overcoming:

- **distrust** among HPTM wholesalers to obtain high volume
- **on-demand** delivery schedules (24/7). Altering schedules might present a problem.
- The immediate and unconditional **produce rejection** and return.
- The **door-to-door** delivery service from the wholesaler/broker to the retailer. The "**last mile**" operation might be a new challenge for some wholesalers, retailers, and brokers.
- The retailer's **spot order**.
- The NIMBY **concerns** of increased traffic, noise, emissions, and other factors.
- The inability to monitor **service quality and customer relations**

- The **toll revenue** reduction from fewer bridge crossings.
- The 3PWDP **definition, role, and function**.
- The Coast Guard compliance requirements of **security regulations** and public access.

Recommendations: Implement an outbound 3PWDP waterborne distribution system slowly, starting in Brooklyn. Brooklyn has the facilities in place for this type of operation and, after the Bronx, it is the largest consumer of produce from HPTM. Furthermore, address the fully implemented waterborne distribution impact on the local added traffic to mitigate its effect and all the other challenges outlined above. It is difficult to envision these challenges resolved soon.

REFERENCES

- [1] *Hunts Point Produce Market*, July 20, 2014, <http://www.huntspointproducemkt.com/about-us/>
- [2] Thompson, James F. and Adel A. Kader, “*Wholesale Distribution Center Storage*,” University of California, Davis, reference to “Thompson, J., A.A. Kader, and K. Sylva. 1996, *Compatibility chart for fruits and vegetables in short-term transport and storage*. Nat. Res. Pub. no. 21560, University of California, Division of Agriculture and Natural Resources, Oakland, CA.”
- [3] Rogoff, Jonah, *Improving Systems of Distribution and Logistics for Regional Food Hubs*, October 2014.
- [4] de Cerreño, Allison L. C. et.al., *Bi-State Domestic Freight Ferries Study*, Rudin Center for Transportation Policy & Management, September 2006.
- [5] DiNapoli, Thomas P., *An Economic Snapshot of the Hunts Point Food Distribution Center*, Office of the Stater Controller, December 2008.
- [6] *Freight Rate Modernization: Improving the Freight Rail & Transfer Facility at the Hunts Point Terminal Produce Market in the South Bronx*, NY, NYCEDC, Page 5.
- [7] *Hunts Point – Sheridan Land Use and Transportation Study*, NYCDOT, NYCEDC, NYCPLANNING, and Department of Housing and Development, Dec 2013, Page 24.
- [8] Tarleton, Jonathan, *The Past and Future of the Hunts Point Produce Market*, *The Architectural League’s Urban Omnibus*, The Culture of Citymaking, Sept. 17, 2013.
- [9] Zalman, Jonathan, *A Perishable Business*, *Narratively*, Sept. 11, 2013.
- [10] plaNYC, *A Stronger, More Resilient New York*, June 11, 2013, Ch, 13, Page. 222.
- [11] <http://www.ask.com/food/many-pounds-food-average-adult-eat-day-3f49d34cd3d872cd>
- [12] <http://www.wsj.com/articles/new-york-city-restaurants-multiply-despite-high-profile-closures-1412816142>
- [13] <https://labor.ny.gov/workerprotection/laborstandards/pdfs/5-20-statistics.pdf>
- [14] #78 Food Supply Study, (Podcast) <https://www.nycedc.com/podcast/78-food-supply-study>

INTERCOMPARISON OF EMISSIONS ASSESSMENT METHODOLOGIES IN A SHORT SEA SHIPPING FRAMEWORK

CLARA BOREN^{*}, MARCEL·LA CASTELLS^{*} AND MANEL GRIFOLL[†]

^{*} Department of Nautical Science and Engineering
Barcelona School of Nautical Studies (FNB)
Universitat Politècnica de Catalunya – BarcelonaTech
Pla de Palau, 18, 08003 Barcelona, Spain
e-mail: cboren@cen.upc.edu, mcastells@cen.upc.edu,

[†] Department of Civil and Environmental Engineering
Barcelona School of Nautical Studies (FNB)
Universitat Politècnica de Catalunya – BarcelonaTech
Pla de Plau, 18, 08003 Barcelona, Spain
e-mail: manel.grifoll@upc.edu,

Keywords: Short Sea Shipping (SSS), Emissions Assessment, Fuel Consumption

Abstract. The objective of this contribution is to compare emissions calculation methods into the context of Short Sea Shipping routes in terms of pollution mitigation. An inventory of methods to calculate fuel consumption and/or CO₂ emissions is elaborated applying them in a Short Sea Shipping route case. Differences between of 16% and 52% are obtained in function of the emission factors and method selected. The potential best suitable method is assessed by combining the monitored parameters and the method inventory. The aforementioned method is found by assessing if the relevant parameters are already monitored/available on board and by analyzing the emissions calculation methodologies in terms of availability of data, accuracy and appropriateness of the method's formulation to be translated into computational language. This analysis is oriented to include the methods in weather ship routing systems.

1 INTRODUCTION

Maritime transport is one of the sources for global warming and environmental pollution. The environmental impact of shipping is expressed by atmospheric emissions as result of the combustion of fossil fuel emissions among other impacts as could be spills or underwater noise, for instance. Shipping accounted in 2012 for approximately 2.8% of global greenhouse gas (GHG, including CO₂, CH₄, and N₂O) emissions. Shipping is responsible for 15% and 13% of global NO_x and SO_x emissions respectively in 2012 [1, 2].

Moreover, it is estimated a growth in the world seaborne trade in the near future on account of world's growing population, which exacerbates air pollution forecasts from maritime transport. As a result, the IMO has developed and adopted more stringent regulations aimed to significantly decrease emissions from vessels. These air pollution regulations focus on reduction of CO₂, NO_x, SO_x and PM, since they are the main emissions of vessel engines.

Various measures and methods are proposed to reduce the environmental impact of shipping like slow steaming, the use of alternative fuels like hydrogen or LNG, or technical and design optimizations; although reducing fuel consumption points out as to be the major aspect for achieving shipping competitiveness. This agrees with an increase of the world tendency to reduce air emissions in the framework to mitigate the climate change effects [3].

The objective of this contribution is to identify the best emissions calculation methodology in the Short Sea Shipping (SSS) context evaluating the differences among the methods and determining the best method using a multi-criteria analysis. Therefore, an assessment of the existing emission calculation methodologies (ECM) is included to attain the goal. Computer model will consider the direct emissions methodology of calculation of air pollutants such as NO_x, SO_x and PM and the global impact of CO₂ emissions issued during sailing from port of departure to port of arrival. The methods are applied in a SSS route, where the ship type, the sailing scenario and the sailing distance determine the amount of emissions.

Following the introduction section (Section 1), this paper continues with the methodology (Section 2) where the criteria analysis is described. Afterwards, results are discussed (Section 3) where the different calculating methods are inventoried and scored in terms of their suitability. In order to finally present some final remarks and determine the best fitting method (Section 4).

2 METHODOLOGY

This paper describes the formal assessment of the different emission calculation methodologies based on a multi-criteria analysis. Figure 1 shows the proposed scheme of this research.

Twelve emission calculation methodologies and the input data they require are proposed as starting point. The emission calculation methodologies can be grouped into 2 types. On the one hand, top-down methodologies combine fuel sales data with emissions factors from available documentation. On the other hand, bottom-up methodologies model fuel consumption and emissions based on vessels' technical and operating conditions. This research has focused on bottom-up methodologies as these are the ones which consider vessels individually.

With the data gathered, each method is qualitatively assessed based on the following criteria:

- Availability and simplicity of assessment method: given by the applied model to calculate the emissions for a certain vessel and the availability of the input data to run the model.
- Accuracy: the accuracy of the data used in an emissions calculation methodology is vital for the integrity of the outcome.
- Appropriateness of the formulation of the method to be translated into computational language: the appropriateness is a subjective concept. The chosen method must be easy to include into the Weather Ship Routing system and has to provide an outcome which represents a realistic value when compared to ship emission inventories from the European Union for the selected type of vessel. [4]

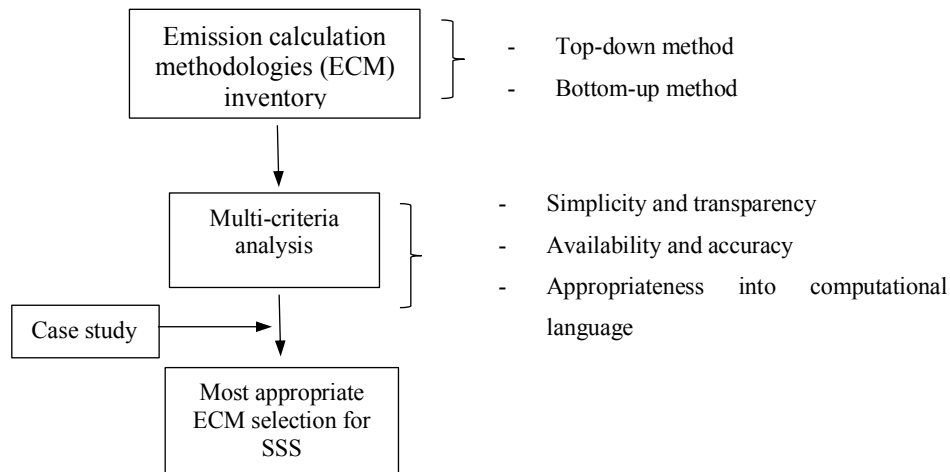

Figure 1: Scheme for research methodology

The case study with the selected methods is carried out, describing the route as well as the ship type in order to perform consequent calculations with regards to the environmental performance of maritime transport. For fleet characterization purposes a database formed by a significant number of vessels engaged in SSS services and calling at Mediterranean ports is used [5]. The ship type selected is a Ro-Ro vessel. In the case of Short Sea Shipping routes, besides navigation at sea, maneuvering in port of departure and arrival and hoteling is not taken into account as Weather Ship Routing would not incise in the emission of pollutants generated while maneuvering in port neither in hoteling periods. This research only considers direct emissions during the actual transport, indirect emissions taking place upstream or downstream is not considered due to lack of reliable data. When it comes to air pollutants emissions estimation, the model considers emissions of NO_x, SO₂, PM and regarding GHG emissions, only CO₂ emissions are considered. Furthermore, only emission factors for conventional fossil fuels are considered (heavy fuel oil, HFO).

3 RESULTS AND DISCUSSION

3.1 Emission calculation methodologies inventory

Twelve methodologies for assessing emissions are considered as a starting point, namely: Bunker fuel tank monitoring; Flow meters for applicable combustion processes; Direct CO₂ emissions measurements (CEM) [6]; On-board monitoring Devices [7]; Use of portable emissions measurement System (PEMS) [8]; Bunker Fuel Delivery Note (BDN) [9]; Use of questionnaires method [10]; Use of tugs [11]; Use of The California Air Resources Board (CARB) Method [12]; Methodologies for estimating shipping emissions in the Netherlands (TNO) [13]; ENTEC UK Limited [14] and Ship Traffic Emissions Assessment Model (STEAM) [15]. The six methodologies mentioned in first place are not taken into account in this research as they deliver direct emissions data or proxies but they are not modelling methods. From the remaining methodologies, only bottom-up methodologies are taken into account because they consider vessels individually. Therefore, this leaves list of three methodologies to

assess. A short description and input data required for these three methodologies are shown in Table 1:

Table 1. Inventory for the bottom-up methodologies for assessing emissions

| Methodology | Description | Input data |
|-------------------------------------------------|-------------------------------------------------------------------------------------------------------------------------------------------------------------------------------------------------------------------|-------------------------------------------------------------------------------------------------------------------------------------------------------------------------------|
| (TNO) | Focus on emission factors and activity data to estimate emissions from berthed ships and from inland and sea shipping. | Fuel consumption, Fuel type Emission factors Statistics of freight transport |
| ENTEC UK Limited | This method makes preliminary assignments of ship emissions to European countries | Distance sailed, cruise speed, ME Power, Load factor for ME |
| Ship Traffic Emissions Assessment Model (STEAM) | Evaluation of exhaust emissions of marine traffic, based on the messages provided by the Automatic Identification System. The model also takes into account the detailed technical data of each individual vessel | Data from AIS (location, instantaneous speed) Ship technical data (ship type, ship speed, engine load, fuel sulphur content, multi-engine set up, abatement method, waves) |

3.2 Multi-criteria Analysis

In order to develop the multi-criteria analysis, it is necessary to know the input data but also parameters required and general assumption for each selected methodology. Table 2 shows a summary of the parameters pointing out general assumptions. Only Main Engines (ME) contribution to global pollution is taken into account.

Table 2. Parameters used and general assumptions for selected methodologies (SFC value taken from manufacturer data; $V_{transient}$: speed from AIS, V_{design} : design speed from Lloyd's Register, V_{safety} : 0.5 kn; P_{inst} : Installed Power) [18]

| ME parameters | ENTEC | TNO | STEAM |
|---------------------------------|-----------------------------|-----------------------------|--------------------------------------------------------------------------------------------|
| Installed power | Lloyd's Register (LR) | LR | LR and Ship Owners |
| Load factor (LF) | 80% at sea | 85% at sea | $LF = 0.8 \left(\frac{V_{transient}}{V_{design} + V_{safety}} \right)^2$ |
| Delivered power | $P(kW) = LF \cdot P_{inst}$ | $P(kW) = LF \cdot P_{inst}$ | $P(kW) = 0.8 P_{installed} \left(\frac{V_{transient}}{V_{design} + V_{safety}} \right)^2$ |
| Specific Fuel Consumption (SFC) | 171 g/kWh | 171 g/kWh | 171 g/kWh |

Table 3 describes and analyses these three bottom-up methodologies in terms of availability, accuracy and appropriateness as depicted hereby:

Table 3. Bottom-up methodologies assessment

| Methodology | TNO | ENTEC | STEAM |
|------------------------|--------------------------------------------------------------------------------------------------------------------------------------------------------------------------------------------------------------------------------------------------------------------------------------------------------------------------------------------|--------------------------------------------------------------------------------------------------------------------------------------------------------------------------------------------------------------------------------------------------------------------------------------------------------------------------------------------------------------------------------------------------------------------------------------------------|-----------------------------------------------------------------------------------------------------------------------------------------------------------|
| | Description | Description | Description |
| Availability | Based in ship movement data (i.e. ships travelling distances) Additional emission factors are derived from LR's tech. data. | This assessment model is not too complex as the underlying formulas are simple multiplications. The complexity stems from the amount of data that has to be handled. | Flexible and versatile methodology. When data is not available, it can be estimated. |
| Accuracy | Based on the assumption that the ship can maintain the design speed at 85% of the (Maximum Continuous Rating) MCR, the energy consumption per distance sailed can be calculated. The disadvantage of this method is that it is focused on Dutch waters and, eventhough it can be used for emissions calculations in a preliminary research | The approach is transparent and the underlying assumptions are explicitly stated. The standard deviation for the calculated sea emissions with this method is estimated to be in the order of 15-25%. In order to attain higher accuracy the distance could be recalculated more accurately and instead of the average emission factors for a ship category the emission factors for the engine types employed on a specific ship could be used. | Sets the basis for approximating values through accurate calculations, as engine power or speed's penalty due to wave effect on navigation, for instance. |
| Appropriateness | The results cannot be extrapolated globally. | The time currently calculated based on an average speed of a ship category and distance travelled could be substituted by AIS data, for instance. | Provides reliable basis for resistance calculation (hull shape, prop. diam., quasi prop. efficiency...). |

3.3 EMC selection for SSS activity: Case Study

The formulas proposed by ENTEC, NTO and STEAM methodologies are applied to a short

distance route with specific ship type using average values (Table 4).

Table 4. Vessel and route's average characteristics considered

| Type of vessel | Av. Speed (km/h) | Av. GT (Tonnes) | Av. Power per engine (kW) | Distance (km) |
|----------------|------------------|-----------------|---------------------------|---------------|
| RO-RO | 41.67 | 32376.4 | 14400 | 776 |

These average values have been taken from a typical West Mediterranean SSS route (Barcelona - Livorno). It has also been assumed that a typical configuration of propulsion system for a RO-RO vessel with about 32300 GT would be 2 medium-speed 4 strokes diesel engines developing an average propulsive power of 14400 kW each.

Figure 2 shows the amount of pollutants in terms of NO_x, SO₂, PM and CO₂ (respectively) considering a vessel with the characteristics shown in table 4 would free into the atmosphere per engine when sailing a distance of 419 Nautical Miles (776km) burning Heavy Fuel Oil. These figures show the results for the bottom-up methodologies selected in the above section. The results show differences of 16 % for the NO_x, 46 % for the SO₂, 52 % for the PM and 17% for the CO₂.

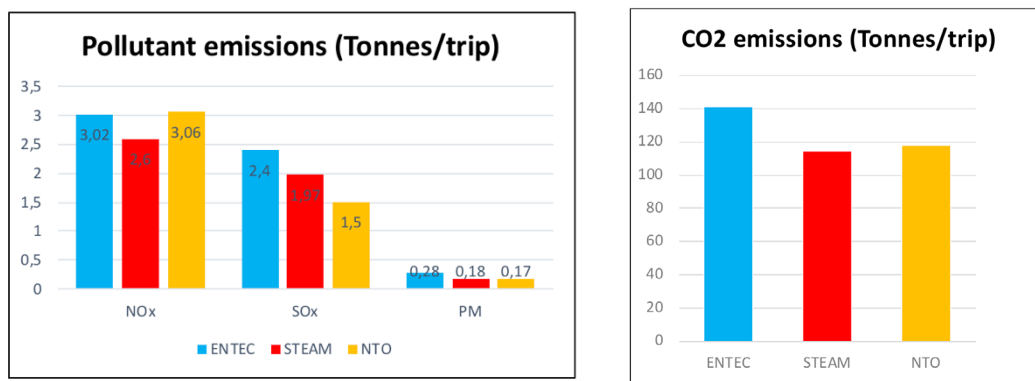

Figure 2. Emissions of NO_x, SO₂ and PM (in Tonnes/trip; left) and CO₂ (in Tonne/trip; right) for the selected methodologies

The simplest method for assessing emissions is to multiply the installed power with a load factor for each activity; even though, there exist more complex methods which take into account instantaneous speed and wave, wind and currents incidence on navigation.

The aforementioned load factor is a key issue in the calculation of specific fuel consumption (SFC) together with the type of fuel burnt and the type of the engine. In a preliminary stage, a constant SFC per engine type can be used. Emissions factors for pollutants are generally expressed in mass per mechanical energy delivered by the engine (g/kWh). For any given year, emission factors are dependent on which types of fuels and engines or machinery were used. However, the impact differs by pollutant. NO_x emission factors mostly depend on engine type, with only a small direct effect of fuel quality while SO₂ (and PM) emission factors and CO₂ are dependent on fuel sulfur and carbon content respectively.

Walsh & Bows [16] make a key remark about the use of emission factors to calculate the amount of emissions from energy consumption. If emission factors are used there need to be a

range of emission factors, relevant emission factors. Uncertainty increases when using generalized emission factors. Relevant emission factors are those which apply for mere specific situations and better cover the processes in these situations. Generalized emission factors may be too generalized for the situation and they may end up implying non-transparent assumptions. The emission factors used in this research, will be the ones proposed by each methodology. Next table shows some information and assumptions applied by the three selected methodologies for calculating the emission factors:

Table 5. Information and assumptions for emission factors assessment [18]

| Emission factors (EF) | ENTEC | TNO | STEAM |
|------------------------------|---------------------------------------------------------------------------------------------------------|--------------------------------------------|--------------------------------------------------------------|
| NO_x | Depend on 5 engine types and 3 fuel types and activity Post-2000: IMO NO _x Technical code | Depend on engine type, build year and load | Engine manufacturer information Default: IMO Tier I Curve |
| SO_x | Depend on S content existence of scrubbers | Depend on S content existence of scrubbers | Depend on S content existence of scrubbers |
| PM | Depend on engine type, fuel type and activity | S content, fuel and engine type | Depend on engine type, S content and engine load |
| CO₂ | Engine type and load | Engine type, build year and load | Engine load |

4 FINAL REMARKS

Taking a look into figure 2, the tons of pollutants emitted into the atmosphere calculated by the chosen methodologies give different results. Differences between of 16 % and 52% are obtained in function of the emission factors. When analyzing this aspect together with the assessment of bottom-up methodologies, it could be concluded that any of them would be suitable for a preliminary research but the balance would finally turn into STEAM side for being the methodology less “emission factor dependent”. This means that STEAM gives the guidance for calculating emissions factors directly depending on the type of fuel, the specific fuel consumption of the engines and the engines load without having to lean on emission factors derived from other researches. STEAM methodology sets also the basis for approximating values through accurate calculations, as engine power or speed’s penalty due to wave effect on navigation, for instance and, furthermore, this method provides reliable basis for resistance calculation taking into account the shape of the hull, estimating the propeller diameter or calculating the quasi propulsive efficiency, among others.

Besides above aspects, STEAM methodology also handles emission factor values which represent a realistic result when comparing them with Technical Report on air pollutant emission inventory (2016) from the European Environmental Agency, thus complying with appropriateness criteria.

Further research will be developed introducing the calculation processes provided by STEAM (1 and 2) into a weather ship routing system in order to assess the fuel consumption and pollutants emissions in short sea shipping routes in Western Mediterranean Region [17]. In

addition, in terms of Monitoring, Reporting and Verification, it could be concluded that modelling with the aid of AIS – as in STEAM – could be very suitable to use as verification method for shipping emissions. Consequently, this key issue will be also included in future activities.

ACKNOWLEDGMENTS

The material and data in this publication have been obtained through the support of the International Association of Maritime Universities (IAMU) and The Nippon Foundation in Japan.

REFERENCES

- [1] IMO. International Maritime Organization. *Third IMO Greenhouse Gas Study 2014* [online]. London: IMO, 2015 [viewed 15 May 2018]. Available from: <http://www.imo.org/en/OurWork/Environment/PollutionPrevention/AirPollution/Documents/Third%20Greenhouse%20Gas%20Study/GHG3%20Executive%20Summary%20and%20Report.pdf>
- [2] CE Delft; Germanischer Lloyd, Marintek; Det Norske Veritas. *Greenhouse Gas Emissions for Shipping and Implementation Guidance for the Marine Fuel Sulphur Directive*. Delft, December: 2006.
- [3] PSARAFTIS H.N. & KONTOVAS C.A. Speed Models for Energy-Efficient Maritime Transportation: A Taxonomy and Survey. *Transportation Research Part C: Emerging Technologies*, 2013, Vol.26, pp. 331-51.
- [4] EEA. European Environment Agency. *EMEP/EEA air pollutant emission inventory guidebook 2016*. Technical Report 21/2016. ISBN 978-92-9213-806-6
- [5] BASIANA, L., CASTELLS, M.; GRIFOLL, M.; MARTÍNEZ, F. J.; BORÉN, C. Ship-weather routing applied to short sea distances: study of the feasibility of SIMROUTEv2 algorithm. In: *International Association of Maritime Universities Annual General Assembly*. "IAMU AGA 17 - 18th International Association of Maritime Universities Annual General Assembly". Varna: 2017, pp. 330-340.
- [6] LLOYD'S REGISTER. *European Union Regulation and Monitoring, Reporting and Verification of Carbon Dioxide from Ships, in Final Legislative Stages*, Executive Summary: 2014.
- [7] EU. European Union. *Regulation 2015/757 of the European Parliament and of the European Council on the Monitoring, Reporting and Verification of Carbon Dioxide Emissions from Maritime Transport, and amending Directive 2009/16/EC*. Brussels: 2015.
- [8] KOUSOULIDOUS M. et al. Use of portable emissions measurement system (PEMS) for

- the development and validation of passenger car emission factors. *Atmospheric Environment*, 2013, Vol. 64, pp.329-338.
- [9] FABER J., NELISSEN D. & SMIT M. *Monitoring of bunker fuel consumption*. Delft, CE Delft, 2013.
- [10] HULSKOTTE J.H.J., DENIER van der Gon H.A.C. Fuel consumption and associated emissions from seagoing ships at berth derived from an on-board survey. *Atmospheric Environment*, 2010, Vol. 44, pp.1229-1236.
- [11] DINH T. *Source inventory: Tugs and Towboats, Dredge vessels and others*. Air Resource Board; 1999.
- [12] CARB. California Environmental Protection Agency. *2007 Ocean-Going Ship Survey*, Appendix C. Stationary Source Division Emissions Assessment Branch, 2007.
- [13] DENIER van der Gon H.A.C. & HULSKOTTE J. *Methodologies for estimating shipping emissions in the Netherlands- A documentation of currently used emission factors and data on related activity*. Netherlands Environmental Assessment Agency - Report 500099012, Netherlands Research Program on Particulate Matter: 2010.
- [14] ENTEC UK Limited. *Service Contract on Ship missions: Assignment, Abatement and Marketbased Instruments Task 2c – SO₂*. European Commission Directorate General Environment Abatement - Final Report. Brussels: 2005.
- [15] JALKANEN J.P. et al. Extension of an assessment model of ship traffic exhaust emissions for particulate matter and carbon monoxide. *Atmospheric Chemistry and Physics*, 2012, Vol. 12, pp. 2641-2659.
- [16] WALSH, C. & BOWS, A. Incorporating lifecycle elements into the energy efficiency design index. *Low Carbon Shipping 2011 International Conference on Technologies, Operations, Logistics and Modelling*. Glasgow, 2011, pp. 22-24
- [17] GRIFOLL, M. Potential Economic Benefits of using a weather ship routing system at Short Sea Shipping. *Journal of Maritime Affairs*, 2018, 17, 195-211.
- [18] EEA. European Environment Agency. *The impact of international shipping on European Air Quality and climate forcing*. Technical Report No. 4/2013 - ISSN 1725-2237

INVESTIGATION OF GROUNDING ACCIDENTS IN THE BAY OF IZMIR WITH THE APPLICATION OF ROOT-CAUSE ANALYSIS

ALI CEMAL TOZ ^{*}, CENK SAKAR ^{*} AND BURAK KOSEOGLU ^{*}

^{*} Dokuz Eylul University Maritime Faculty
Tinaztepe Campus Buca, 35160, Izmir, Turkey
e-mail: ali.toz@deu.edu.tr, cenk.sakar@deu.edu.tr, burak.koseoglu@deu.edu.tr

Keywords: Bay of Izmir, Root-Cause Analysis, Grounding, Ship, FTA.

Abstract

City of Izmir as the third largest city of Turkey, is the opening gate of Anatolia to the world through Aegean Sea. The city with its great volume of cargo capacity plays crucial role both in international and domestic sea trade. The Port of Alsancak located at the inner part of the bay is the largest seaport of Aegean Region in terms of annual loading capacity. The main objective of this research is to find the root-causes of accidents that have resulted in the groundings in Bay of Izmir. To do this, the Root Cause Analysis methodology was carried out on the accidental data provided by Turkish Main Search and Rescue Coordination Center (TMSRCC). Between 2001 and 2016, a total of 24 ships grounded at the entrance of Yenikale due to shallow water conditions, which is regarded as the riskiest point in terms of groundings. In this study, the Fault Tree Analysis (FTA) method which is the one of the most preferred root cause analysis methods was used. As a result, it was found that equipment failures and geographical factors are the main reasons of grounding accidents in Bay of Izmir. In order to eliminate these causes, necessary precautions have been offered and suggestions for further studies have been made.

1 INTRODUCTION

Ship grounding can be defined as a contact of a ship hull with the ground [1]. Grounding of ship is a type of accident that can cause destructive secondary consequences such as sinking of the ship, fire/explosion and environmental pollution [2]. Groundings and fires on board are the dominant types of shipping accidents worldwide. Between 1990 and 2013, the second most important cause of ship accidents, which resulted in total loss, is grounding [3]. There are many reasons for the accidents resulting in the grounding of the ships. The main causes of these accidents are human error, equipment failure and heavy weather conditions [2,4,5,6]. In this study, it is aimed to determine the root causes of the ship accidents in Bay of Izmir, where groundings are frequently experienced.

2 LITERATURE REVIEW

In the literature, there are many studies investigating the root causes of ship accidents. [7] carried out a study through Fault Tree Analysis (FTA) method in order to find root causes of collision and grounding of oil tankers. Finally, the factors of “colreg violation and lack of communication” under human error origin have been found the root causes which have the

great effects on collision and grounding accidents.

[8] aimed to investigate the potential risks causing accidents in passenger ships (Ro-Pax) and the role of human error in these incidents. In their study, Formal Safety Assessment (FSA) and FTA methods were used to identify hazards and their impact levels on related accidents. Finally, it was resulted that the human error has the highest contribution to the result in ship grounding and collision accidents. [9] used FTA method to investigate root causes of tanker accidents during loading and unloading operations in terminals. They concluded that “failure to comply with operating procedures” and “lack of knowledge” is the most important factors. [10] aimed to construct a fault tree model considering both fires and explosions in a dual fuel ship. [11] carried out a fault tree analysis on ship drift emergency of Three Georges Lock with the method of FTA. They concluded that heavy wave conditions, mechanical failures and improper loading have the highest effects on drifting situation. [12] developed a grounding and collision analysis toolbox (GRACAT) to analyze the probabilities of collisions and groundings in Southeast Texas Waterways. It was found that the probabilities of collisions increase with the increase of the traffic volume and groundings are much more likely to occur than vessel collisions in the area due to the current conditions. [13] used an approach concentrating FTA and event trees analysis (ETA) incorporating The Human Error Rate Prediction (THERP) data to quantify individual errors.

3 MATERIALS AND METHOD

In this study, the FTA method as one of the most commonly used risk assessment technique was carried out to investigate probability of root causes and their impact level on grounding accidents in Izmir Bay.

3.1. FTA method

Fault Tree Analysis (FTA) is deductive risk analysis in which an undesired event is analyzed using Boolean approach to integrate a series of sub events. The FTA method is utilized both for qualitative and a quantitative purpose. Qualitatively it is used to identify the individual scenarios that lead to the top event, while quantitatively the probability of each factor is determined. The main determinants of a Fault Tree are composed by the top event, primary events, intermediate events and logic gates [8]. A simple fault tree is shown in Figure 1.

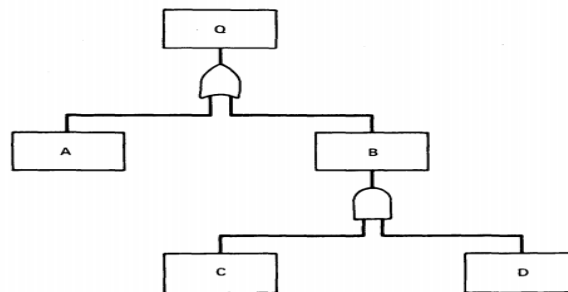

Figure 1: A simple fault tree design
Source: [14]

In this figure, “Q output” is illustrated as a top event. “A” is illustrated as a primary event. “B” is illustrated as an intermediate event. If all of the input faults happen, “And gate” is used between inputs and output. If least one of the input faults happens, “Or Gate” is used between inputs and output [14].

3.1.1 Qualitative analysis

The aim of qualitative analysis is to construct minimum cut sets (MCSs) which are combinations of the smallest number of basic events of the fault tree. The classic fault tree is mathematically represented by a set of Boolean equations as shown below.

Algebraic representation is:

$$Q = (A \cup C) \cap (D \cup B) \cup \text{or gate} \cap \text{and gate}$$

which can be re-written as:

$$Q = (A \cap D) \cup (A \cap B) \cup (C \cap D) \cup (C \cap B)$$

$$Q = (A \cdot D) + (A \cdot B) + (C \cdot D) + (C \cdot B)$$

which is a listing of Groupings ...each of which is a Cut Set

AD AB CD BC

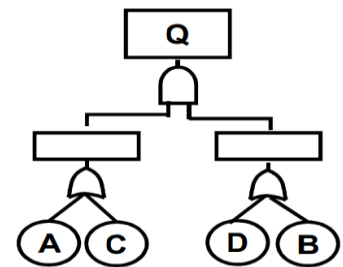

3.1.2 Quantitative analysis

The quantitative fault tree analysis represents a calculation of the top event probability, equal to the failure probability of the corresponding load. The total contribution and probability values for these root causes were calculated by using the following formulas [9]:

$$TCAC = \frac{1}{RC_1} + \frac{1}{RC_2} + \dots + \frac{1}{RC_n} \tag{1}$$

TCAC: Total Contribution of Accident Cause

RC₁: A total Number of Root Causes in Ship Accident 1

$$PVAC = \frac{TCAC}{SN \times TY} \tag{2}$$

PVAC: Probability Value of Accident Cause

SN: Ship Number

TY: Total Year

The total contribution rates and probabilities of root causes according to the above formulation are shown in Table 1.

Table 1: Accident causes and frequency of their occurrence

| No | Accident Cause | Frequency | Total Contribution | Probability |
|----|--------------------|-----------|--------------------|-------------|
| 1 | Steering Failure | 3 | 3 | 8.33E-03 |
| 2 | Violation of Rules | 2 | 2 | 5.56E-03 |
| 3 | Autopilot Failure | 1 | 1 | 2.78E-03 |
| 4 | Engine Failure | 2 | 2 | 5.56E-03 |

| | | | | |
|----|---------------------------------|---|-----|----------|
| 5 | Bad Weather Conditions | 2 | 2 | 5.56E-03 |
| 6 | Collision Avoidance Maneuvering | 2 | 2 | 5.56E-03 |
| 7 | Fatigue | 1 | 1 | 2.78E-03 |
| 8 | Alcohol Abuse | 2 | 3/2 | 4.17E-03 |
| 9 | Lack of BRM | 2 | 2 | 5.56E-03 |
| 10 | Shallow Water Conditions | 2 | 2 | 5.56E-03 |
| 11 | Inappropriate Voyage Planning | 2 | 2 | 5.56E-03 |
| 12 | Generator Failure | 2 | 2 | 5.56E-03 |
| 13 | Lack of attention | 1 | 1 | 2.78E-03 |

A total of 13 root causes in 24 grounding accidents between 2001 and 2016 has been determined with the analysis of accident reports provided by Turkish Main Search and Rescue Coordination Center (TMSRCC). In addition, some data not included in the accident reports are provided from the marine pilots working in Izmir Bay.

3.2 Study Site

Bay of Izmir as one of the most important waterway for the oceangoing vessels carrying huge amount of cargo to the Alsancak Port as a seaport integrated with commerce and industry. The Bay is surrounded with the city of Izmir that plays an important role in maritime transportation [15]. Location and depth characteristics of Bay of Izmir as study area are shown in Fig. 2.

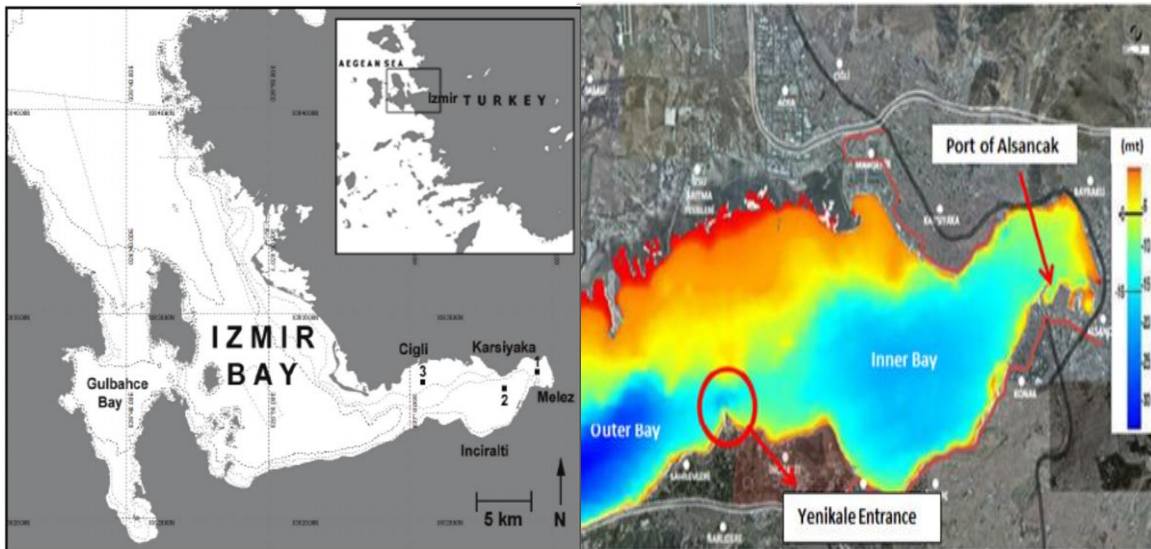

Figure 2: Study area map: bay of Izmir, Turkey.

Source: [15]

As clearly understood from the table that shallow water conditions due to alluvium accumulation by Gediz River at Yenikale entrance have negative effects on navigation safety of ships entering and leaving the bay [15]. Therefore, Yenikale Entrance where grounding accidents frequently occur is the riskiest point of Izmir Bay.

3.3 Findings and Results

In this study, the grounding accidents in Izmir Bay were considered for evaluation. A total of 24 events caused by 13 factors were determined. Initially the fault tree including main, intermediate and root causes was constructed then, the probabilities of sub-events and their impact level were calculated with the application of Open FTA software. The details of the accidents are shown in Table 2.

Table 2: Details of groundings in Izmir Bay

| No | Ship Type | GRT | Flag State | Accident Cause | Accident Type |
|----|---------------|-------|-------------|---------------------------------|---------------|
| 1 | Dry Cargo | 1923 | Turkey | Violation of Rules | Grounding |
| 2 | Dry Cargo | 4951 | Turkey | Violation of Rules | Grounding |
| 3 | General Cargo | 2584 | St. Vincent | Autopilot Failure | Grounding |
| 4 | Dry Cargo | 5044 | Gibraltar | Engine Failure | Grounding |
| 5 | Dry Cargo | 20276 | Greece | Heavy Weather Conditions | Grounding |
| 6 | Container | 42336 | Germany | Collision Avoidance Maneuvering | Grounding |
| 7 | Dry Cargo | 2457 | Georgia | Fatigue | Grounding |
| 8 | Container | 20624 | Malta | Alcohol Abuse | Grounding |
| 9 | Dry Cargo | 2457 | Comoros | Lack of BRM | Grounding |
| 10 | Ro-Ro | 33825 | Italy | Engine Failure | Grounding |
| 11 | Container | 23897 | Germany | Generator Failure | Grounding |
| 12 | Dry Cargo | 1972 | D. Republic | Steering Gear Failure | Grounding |
| 13 | Dry Cargo | 2457 | Cambodia | Alcohol Abuse | Grounding |
| 14 | Dry Cargo | 986 | Turkey | Steering Failure | Grounding |
| 15 | Container | 10282 | Turkey | Lack of BRM | Grounding |
| 16 | Container | 24836 | England | Collision Avoidance Maneuvering | Grounding |
| 17 | Dry Cargo | 15698 | Panama | Steering Gear Failure | Grounding |
| 18 | Container | 15859 | Liberia | Heavy weather Conditions | Grounding |
| 19 | Dry Cargo | 1042 | Syria | Shallow Water Conditions | Grounding |
| 20 | Dry Cargo | 489 | Turkey | Inappropriate voyage | Grounding |
| 21 | General Cargo | 708 | Tonga | Lack of Attention | Grounding |
| 22 | Dry Cargo | 1198 | Cambodia | Inappropriate Voyage Planning | Grounding |
| 23 | Dry Cargo | 16382 | Greece | Shallow Water Conditions | Grounding |
| 24 | Dry Cargo | 768 | Denmark | Generator Failure | Grounding |

It is seen that a large part of the vessels are foreign flagged and small tonnage. The ship accidents were tested with Monte Carlo Simulation using Open FTA program. Contribution ratios and importance levels for each root cause were obtained. A total of 89 failure modes from 13 initial events were found for grounding accidents. The values for these data are given in Table 2.

Table 3: Monte carlo simulation initial event contribution rates for grounding accidents

| No | Initial Event | Failure Contribution | Importance Level | Percentage Rate (%) |
|----|--------------------------------------|----------------------|------------------|---------------------|
| 1 | X11 (Rudder Failure) | 7.834666E-003 | 13.48 | 13.85 |
| 2 | X12 (Shallow Water Conditions) | 5.591208E-003 | 9.62 | 9.88 |
| 3 | X4 (Lack of BRM) | 5.416846E-003 | 9.32 | 9.57 |
| 4 | X13 (Heavy Weather Conditions) | 5.352914E-003 | 9.21 | 9.46 |
| 5 | X1 (Collision Avoidance Maneuvering) | 5.318041E-003 | 9.15 | 9.40 |
| 6 | X8 (Engine Failure) | 5.259921E-003 | 9.05 | 9.30 |
| 7 | X10 (Generator Failure) | 5.207612E-003 | 8.96 | 9.20 |
| 8 | X6 (Alcohol Abuse) | 3.940581E-003 | 6.78 | 6.96 |
| 9 | X3 (Inappropriate Voyage Planning) | 2.592182E-003 | 4.46 | 4.58 |
| 10 | X2 (Violation of Rules) | 2.563121E-003 | 4.41 | 4.53 |
| 11 | X5 (Lack of Attention) | 2.528249E-003 | 4.35 | 4.47 |
| 12 | X9 (Autopilot Failure) | 2.493377E-003 | 4.29 | 4.41 |
| 13 | X7 (Fatigue) | 2.487565E-003 | 4.28 | 4.40 |

As understood from the table that X11 which is named as “Rudder Failure” is the most important factor and has the biggest contribution in grounding accidents. “Lack of BRM” and “Shallow Water Conditions” are the second and the third important factors in accidents. It is also seen that accidents caused by equipment faults frequently occur.

In addition, although the bay is located in a natural protected area, bad weather conditions nevertheless caused grounding. Again the results show that the effect of human error on accidents is lower than the others. Besides, many boats engaged in fishing in the area and their captains who do not know the rules of Colreg cause the ships to ground. As well as other types of boats causing accidents due to lack of information on restricted passage conditions for ships.

Alcohol abuse is the other root cause of grounding accidents. This cause was not provided by the accident reports. This data was obtained from interviews with pilot masters. Especially this cause is the main factor of grounding accidents of river type vessels called as volgo-balt.

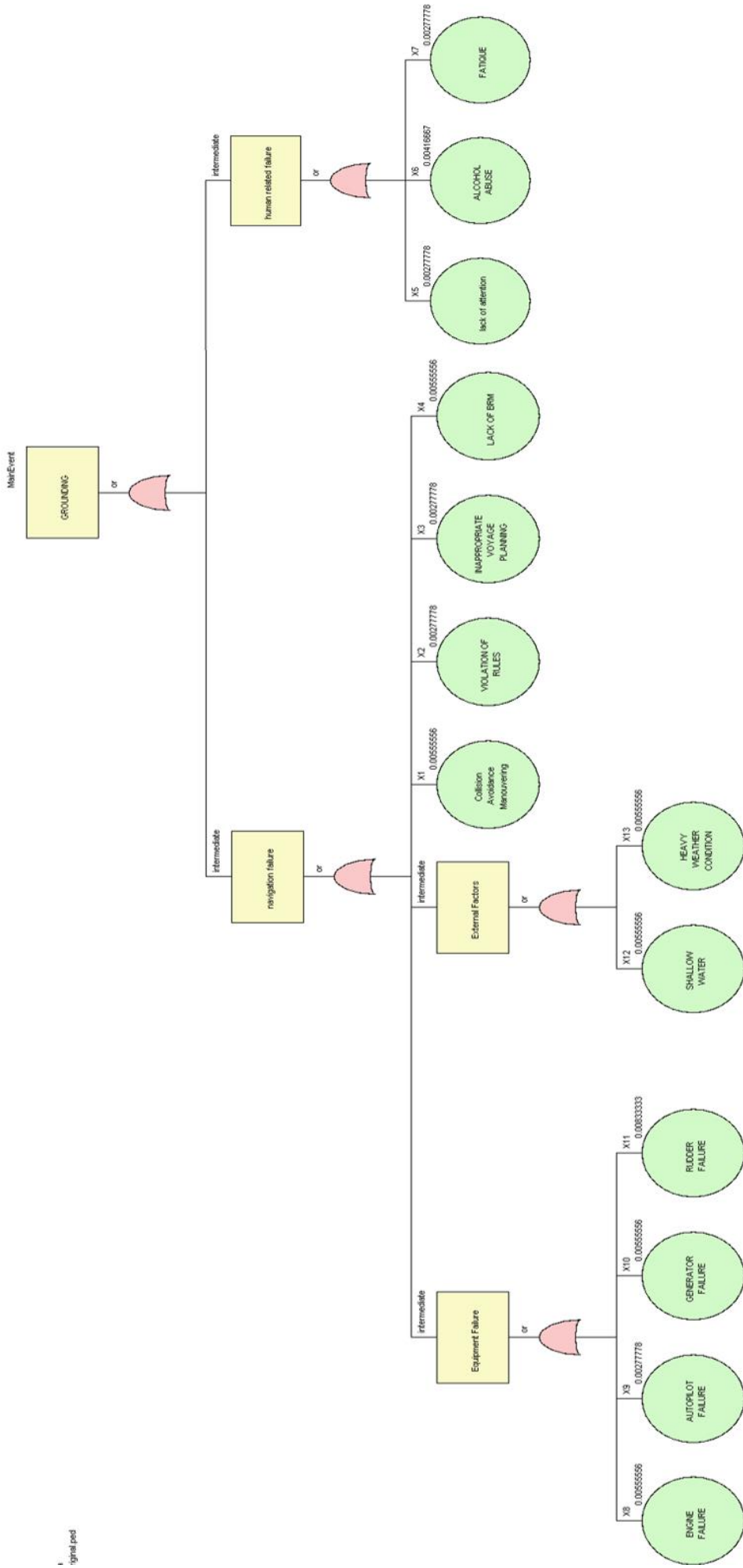

Figure 3: Fault tree for grounding accidents

CONCLUSIONS

In this study, a total of 24 grounding accidents in the Bay of Izmir between 2001 and 2016 have been investigated. It has been resulted that ship accidents, which result in grounding due to geographical constraints of the region, are frequently experienced. Therefore, it is aimed to determine the precautions that should be taken in order to prevent these accidents from happening again.

In this study, it is seen that the most important factor in the accidents is the rudder failure under equipment fault. Although these failures seem to be caused by malfunctions on their own, it is known that the inadequate maintenance measures may also cause this fault. In both cases, regular maintenance operations should be carried out and inspections should be conducted by authorities.

Especially due to the limited maneuvering area in the region, it is impossible for the vessels in emergency to make grounding avoidance maneuvers. In this context, some precautions both for geographical limitations and other factors should be taken in order to prevent grounding accidents. For short term solution it is suggested to carry out a dredging operations in order to extend of the maneuvering area for safety of navigation. On a long-term basis, some precautions can be taken for the Gediz Delta, which causes the bay to be shallow.

In addition, pilotage service area should be extended to include risky areas. For example, pilot embarkation station can be transferred to the outer region of the bay. Besides, the Vessel Traffic Services (VTS), established in 2016 and fully operational in 2018, is expected to play an important role to prevent future accidents. The VTS will also be an actor in terms of controlling of the maritime traffic in the region at the same time.

The most important limitations of the study are the insufficient and incomplete data of the accident reports provided. A more comprehensive study can be carried using reports with more detailed information. In this study, FTA was used as a risk assessment method. Different methods can be used in future studies for better solutions.

REFERENCES

- [1] Mazaheri, A. and others. Modeling the risk of ship grounding—a literature review from a risk management perspective. In: *Journal of maritime affairs WMU* [online]. 2013. 12. [viewed date 15 May 2018]. Available from: <http://dx.doi.org/10.1007/s13437-013-0056-3>.
- [2] Akten, N. Shipping accidents: a serious threat form marine environment. In: *Journal of the Black sea/Mediterranean environment*. 2006. 12 (3). 269–304.
- [3] Primorac, B. and Parunov, J. *Review of statistical data on ship accidents*. In: *Maritime technology and engineering*. Lisbon, Portugal. 2016.

- [4] Acar, U. and others. Collisions and groundings – major causes of accidents at sea. *Marifuture papers*. 2008. 48–51. [viewed date 12 May 2018]. Available from: <http://www.marifuture.org/Publications/Papers.aspx>.
- [5] Kılıç, A. and Sanal, H. T. Çanakkale boğazi'nda karaya oturma ile sonuçlanan gemi kazaları. In: *Journal of Balıkesir Üniversitesi Fen Bilimleri Enstitüsü*. 2016. 17(2). 38-50.
- [6] Papanikolaou, A. and others. Casualty analysis of Aframax tankers. In: *J. Engineering for the Maritime Environment*. 2007. 221(2). 47–65.
- [7] Ugurlu, O. and others. Analysis of grounding accidents caused by human error. In: *Journal of marine sciences*. 2015. 23(5). 748-760.
- [8] Antão, P. and Soares, C. Fault-tree models of accident scenarios of Ro-Pax vessels. In: *Int J. Auto. Comput.* 2006. 3. 107.
- [9] Arslan, O. and others. Fault tree analysis of tanker accidents during loading and unloading operations at the tanker terminals. In: *Journal of eta maritime science*. 2018. 6. 3-16.
- [10] Guan, Y. and others. Fault tree analysis of fire and explosion accidents for dual fuel (diesel/natural gas) ship engine rooms. In: *Journal of marine. sci. appl.* 2016. 15. 331.
- [11] Tang, L. and Guobin, Wu. Fault tree analysis on ship drift emergency of three Georges lock. In: *Proceedings of IEEE*. 2009. pp. 4244-4639.
- [12] Wu, X. and others. Probability analysis of vessel collisions and groundings in southeast texas waterways. In: *Transportation research record: journal of the transportation research board*. 2014. 44-53.
- [13] Amrozowicz, M. D. and others. A probabilistic analysis of tanker groundings. In: *The seventh international offshore and polar engineering conference*. International Society of Offshore and Polar Engineers. 1997.
- [14] Vesely, W. E. and Roberts, N. H. Fault tree handbook. United States Nuclear Regulatory Commission. 1981.
- [15] Toz, A. C. and Koseoglu, B. Trajectory prediction of oil spill with Pisces 2 around Bay of Izmir, Turkey. In: *Marine pollution bulletin*. 2018. 126. 215-227.

RESEARCH ON NEW OBSTACLE AVOIDANCE ALGORITHMS FOR SHIPS

A. LAZAROWSKA

Department of Ship Automation
Gdynia Maritime University
81-87 Morska St., 81-225 Gdynia, Poland
e-mail: a.lazarowska@we.am.gdynia.pl, web page: <http://www.am.gdynia.pl>

Keywords: Collision Avoidance, Decision Support, Safe Trajectory, Ship Navigation

Abstract. The contribution reports the progress of a research project for Young Academic Staff in FY2018. The project is dedicated to the development of a path planning module, constituting a part of an intelligent control system for ships - a Guidance, Navigation and Control (GNC) system. The paper describes the stages of the project, including already carried out research tasks and tasks planned to be performed. Preliminary simulation and real experiments results are presented in the paper. The outcome of the research will contribute to the development of new solutions for safer and more efficient shipping.

1 INTRODUCTION

Ensuring the safety of ship navigation is one of the fundamental issues in marine transport. Technological development enables application of systems aimed at ship's collision avoidance. Recent trends include decision support, remote control of a ship and finally autonomous navigation. The objective of new collision avoidance solutions development is the achievement of more efficient, safer and greener shipping. The aim of a research presented in this paper is the development of new, original, effective algorithms for the determination of a safe, optimal path for a ship in a collision situation at sea. The algorithms will be tested by carrying out simulation and experimental studies. Ship's trajectory planning methods have been recently revised in [1,2,3]. The aim of the carried out research is to develop a method for ship's trajectory planning, characterized by low run time, repeatability of solution, consideration of both static and dynamic obstacles and the International Regulations for Preventing Collisions at Sea (COLREGs), and therefore applicable in a commercial Decision Support System.

2 INTELLIGENT SHIP CONTROL SYSTEM

Modern ship control systems have a structure show in Fig. 1. They are known as Guidance, Navigation and Control (GNC) systems [4]. The GNC system is composed of three main subsystems: the Guidance System, responsible for path planning, the Control System, responsible for motion control and the Navigation System, responsible for measurement of motion parameters (ship's position, course and speed). The basic component of the path planning module (the Guidance System) is called the Trajectory Generator (TG). An

advanced optimization algorithm, constituting the core of the TG, calculates a safe, optimal path for a ship.

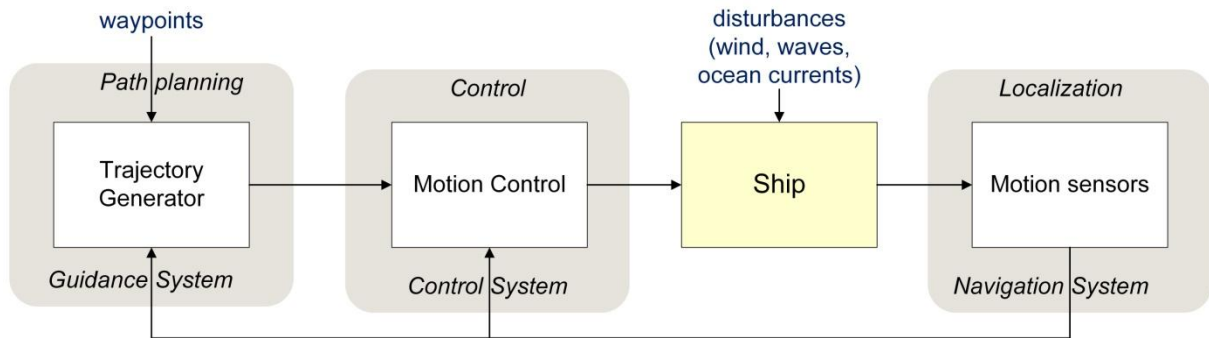

Figure 1: Guidance, Navigation and Control system

3 SHIP TRAJECTORY CALCULATION

Ship collision avoidance is a complex optimization problem with various restrictions and requirements to be considered. The ship's trajectory planning algorithm has to fulfil the following assumptions:

- availability of navigational data describing the current situation at sea;
- the International Regulations for Preventing Collisions at Sea (COLREGs) compliance of the calculated trajectory [5];
- static (lands, shallows) and dynamic (target ships - TSs) obstacles taken into account;
- safe distance (D_S) taken into account;
- trajectory calculated between the current own ship (OS) position and the defined final waypoint of the trajectory;
- dynamic properties of the OS considered;
- TSs maintain their motion parameters;
- weather conditions (visibility) taken into account.

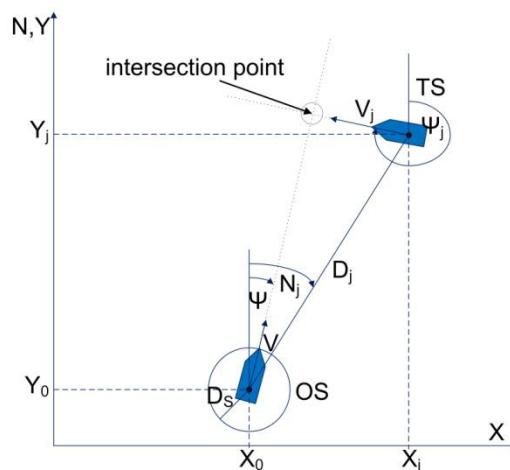

Figure 2: Description of navigational situation

Navigational data needed for the algorithm include an OS course (Ψ) and speed (V), TSs courses (Ψ_j), speeds (V_j), bearings (N_j) and distances from an OS (D_j), information concerning position of static constraints (lands, islands, buoys, fairways, canals, shallows) and visibility/weather conditions. The navigational data describing actual situation at sea are marked in Fig. 2. These data are registered from navigational equipment such as a radar with an Automatic Radar Plotting Aid (ARPA), an Automatic Identification System (AIS), an Electronic Chart Display and Information System (ECDIS), a gyrocompass, a speed log, an echo sounder, a Global Positioning System (GPS) or a Differential Global Positioning System (DGPS), wind speed and direction sensors.

The COLREGs compliance means determining adequately large course alteration manoeuvres (rule 8b) and a manoeuvre on the relevant side of the ship (rules 14, 15). A safe distance is assured by the application of a ship domain around TSs. Weather conditions such as visibility (poor or good) are taken into account by an application of a proper size of the TSs domain. It is assumed that the TSs maintain their course and speed. The solution is recalculated if changes in motion parameters of TSs and/or new TSs are detected.

4 OBSTACLE AVOIDANCE ALGORITHMS

The project has been divided into several stages as shown in Fig. 3.

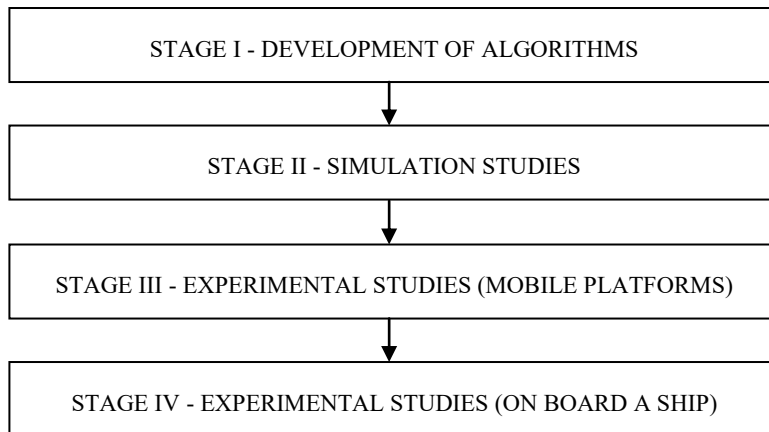

Figure 3: Stages of the project

Two different algorithms, one deterministic and one heuristic, have already been developed for application to ship's trajectory calculation problem.

The Trajectory Base Algorithm (TBA) is a deterministic method using a simple concept of searching a predefined set of trajectories in order to find the shortest safe trajectory for the considered situation. A detailed description of the approach is presented in [6]. The method is very fast and effective for simpler scenarios. The computational time might increase for complicated situations.

$$p_{wp_{ij}}^{ant}(t) = \frac{[\tau_{wp_j}(t)]^\alpha \cdot [\eta_{wp_{ij}}]^\beta}{\sum_{l \in wp_i^{ant}} [\tau_{wp_l}(t)]^\alpha \cdot [\eta_{wp_{il}}]^\beta} \quad (1)$$

A different algorithm for ship's safe trajectory calculation is based upon a heuristic method called the Ant Colony Optimization (ACO) [7]. The method was inspired by an observation of an ant colony foraging behaviour. It was discovered that ants, when searching for food, use a special mechanism to find the shortest path between the food source and their nest. This mechanism constituted an inspiration for the development of the Ant Colony Optimization. This algorithm is applied to solve the ship's safe trajectory calculation problem and is particularly suitable for complex navigational situations. In this approach an artificial ant chooses the next OS position (the vertex on the graph) with the use of Equation (1), expressing the probability of choosing the next vertex. The choice of the next vertex depends on the value of the pheromone trail ($\tau_{wpj}(t)$) on the neighboring vertex and the heuristic information called visibility (η_{wpj}). The heuristic information is the inverse of the distance between the current vertex (i) and the neighboring vertex (j). A detailed explanation of the algorithm is given in [8].

5 SIMULATION STUDIES

The simulation studies will be carried out with the use of the MATLAB environment. Simulation studies will include both simple (1-3 TSSs) and more complex (up to 10 TSSs) navigational situations and situation with both static and dynamic obstacles in the environment. Exemplary results for an encounter situation with eight target ships are presented in Fig. 4. The same OS trajectory was received for both algorithms - ACO and TBA, but the run time of the algorithms was different. The run time of ACO, for calculations conducted with the use of a PC with an Intel Core 2 Duo E7500 2.93 GHz processor, 4GB RAM, 64-bit Windows 7 Professional, reached about 20 - 30 seconds, while for TBA it was 2 seconds.

Input data to the algorithm for this situation are listed in Table 1.

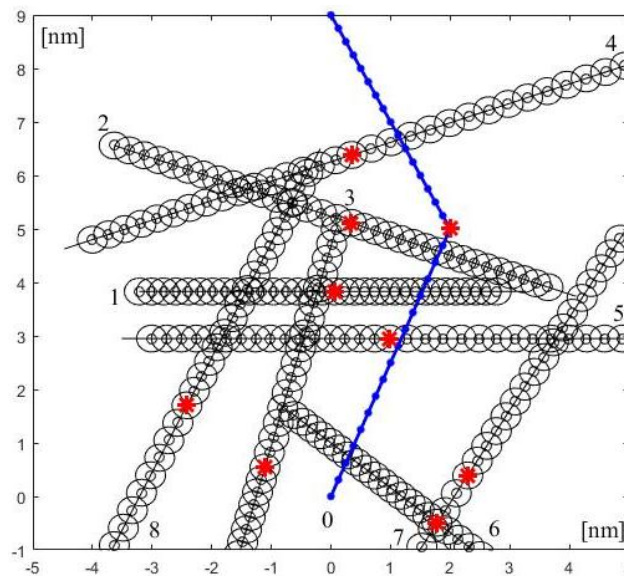

Figure 4: Encounter situation with eight target ships solved by the TBA and ACO algorithms (OS trajectory marked by blue line), OS course: 22°, 333° (red stars mark the positions of all ships at the moment, when an OS is changing its course)

Table 1: Data describing an exemplary navigational situation

| Ship | Course [°] | Speed [kn] | Distance [nm] | Bearing [°] |
|------|------------|------------|---------------|-------------|
| 0 | 0 | 14 | - | - |
| 1 | 90 | 8.5 | 5 | 320 |
| 2 | 110 | 11 | 7.5 | 331 |
| 3 | 195 | 12 | 5 | 1 |
| 4 | 250 | 14.5 | 10 | 34 |
| 5 | 270 | 12.5 | 6.5 | 63 |
| 6 | 310 | 9.8 | 5.5 | 122 |
| 7 | 30 | 16 | 5 | 189 |
| 8 | 25 | 15 | 6 | 234 |

6 EXPERIMENTAL STUDIES

Experimental studies will include two stages. At stage III of the project the developed ship's path planning algorithms will be tested with the use of a system composed of a group of mobile platforms and an Indoor Positioning System (IPS) for localization of the moving objects.

The IPS from Pozyx labs [9] is composed of tags placed on mobile platforms, providing information about their position and direction of movement, and four nodes (anchors) with known positions. The tag contains an ultra-wideband transceiver and an inertial measurement unit DWM1000 from DecaWave for measuring the orientation of an object, including accelerometers, gyroscopes and magnetometers.

The mobile platforms DFRobot Pirate-4WD [10] with the dimensions of 200 x 170 x 105 mm (length x width x height) and a speed of up to 0.9 m/s, equipped with 4 DC motors and characterized by differential-drive steering will be used in experiments. The results of experimental studies for situation with one dynamic obstacle in the environment are shown in Fig. 5. The mobile platform is marked as 0x6973, an obstacle is marked as 0x6e42. Objects marked by 0x697b, 0x6924, 0x6929 and 0x6909 are the anchors of the IPS.

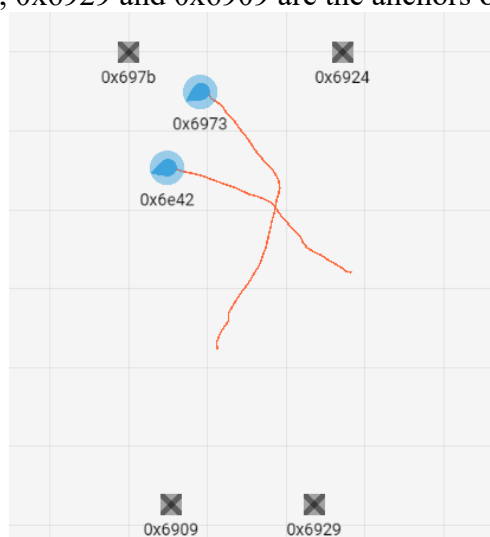

Figure 5: Results of experimental studies for an encounter situation with one dynamic obstacle registered with the use of an Indoor Positioning System

At stage IV of the project the problem solving capability of the developed solution will be proven by its implementation in the GNC system and performed tests on board the Research/Training ship M/V Horyzont II under operating conditions.

Horyzont II is a Research/Training ship owned by Gdynia Maritime University. It performs a research function, a training function for students and a transport function for Polish Academy of Sciences – transporting equipment to the Polish scientific bases on Spitsbergen. Table 2 shows the main technical parameters of the vessel.



Figure 6: Research/Training ship M/V Horyzont II

Table 2: Technical specification of M/V Research/Training Ship Horyzont II

| | |
|----------------------------------|----------------------------------------|
| Length | 56.34 m |
| Breadth | 11.36 m |
| Designed draft | 3.90 m (5.33 m together with the keel) |
| Deadweight | 288 t |
| Gross Tonnage | 1321 BRT |
| Speed | 12 knots |
| Main engine power | 1280 kW |
| Controllable Pitch Propeller CPP | CP 65 WARTSILA , D = 2.1 m |
| Bow thruster | STT 10 LK SCHOTTEL - power: 125 kW |
| Build year and place | 2000, Gdańsk |
| IMO Number | 9231925 |

Input data for the algorithm are transmitted from an ARPA with the use of the NMEA standard. It is a serial asynchronous data transmission protocol used for communication between marine electronic equipment and external devices. The standard defines the data frame structure: one start bit, eight data bits, no parity bit and one stop bit, and the transmission speed: 4800 bits per second. It also defines the transmitted sentences structures. The sentences needed for the algorithm are marked as OSD (Own Ship Data) and TTM (Tracked Target Message). The standard repetition time of OSD sentence is 1 second and of TTM sentence is 10 seconds. The sentence structures concerning Own Ship Data and Tracked Target Message are as follows:

\$RAOSD,a.a,A,c.c,X,x.x,Y,y.y,z.z,N*hh<CR><LF>

RA - talker identifier: RA - radar

OSD - sentence formatter: OSD - own ship data

a.a - heading, degrees true

A - heading status: a - valid, V - invalid

c.c - vessel course, degrees true

X - course reference: W - water-referenced

x.x - vessel speed

Y - speed reference: W - water-referenced

y.y - vessel set, degrees true

z.z - vessel drift (speed)

N - speed units: N - knots

\$RATTM,aa,b.b,c.c,T,t.t,x.x,T,y.y,z.z,X,n,Y,R,hhmmss.ss,M*hh<CR><LF>

RA - talker identifier: RA - radar

TTM - sentence formatter: TTM - tracked target message

aa - target number: 00 to 99

b.b - target distance from own ship

c.c - bearing from own ship

T - degrees true

t.t - target speed

x.x - target course

y.y - DCPA - distance at closest point of approach

z.z - TCPA - time to the closest point of approach [min]

X - speed, distance units

n - user data (e.g. target name)

Y - target status: L - lost, Q - query (target in the process of acquisition), T - tracking

R - reference target (used to determine own ship speed)

hhmmss.ss - time of data (UTC) M - type of acquisition: a - automatic, M - manual,

R - reported (eg.AIS)

The real navigational data describing the current situation at sea will be registered during the Horyzont II voyages. After that the algorithm will be tested whether it is capable of finding solutions for real navigational situations.



Figure 7: The interior of the bridge of the Research/Training ship M/V Horyzont II

7 CONCLUSIONS

The research presented in this paper deals with the problem of ship's safe trajectory calculation in a collision situation at sea. The paper presents the progress of a research project for Young Academic Staff in FY2018. The main goal of the presented research is the development of new path planning solutions for ships, which will contribute to achieve safer shipping and progress in autonomous navigation.

Preliminary research results lead to the following conclusions:

- the TBA and ACO algorithms are capable of finding a ship's safe trajectory in collision situations at sea with both static and dynamic obstacles;
- the run time of both algorithms does not exceed 1 minute, therefore the algorithms are suitable for use in commercial systems;
- the results of real experiments with navigational situations registered on board the ship will be used to further validate the presented methods.

ACKNOWLEDGEMENTS

The author would like to thank The Nippon Foundation in Japan and the International Association of Maritime Universities (IAMU) for funding and supporting this research.

REFERENCES

- [1] Statheros T., Howells G. and Maier K.M. Autonomous ship collision avoidance navigation concepts, technologies and techniques. *Journal of Navigation*. 2008, (61), 129-142. ISSN 0373-4633.
- [2] Tam C., Bucknall R. and Greig A. Review of collision avoidance and path planning methods for ships in close range encounters. *Journal of Navigation*. 2009, (62), 455-476. ISSN 0373-4633.
- [3] Campbell S., Naeem W., Irwin G. A review on improving the autonomy of unmanned surface vehicles through intelligent collision avoidance manoeuvres. *Annual Reviews in Control*. 2012, (36), 267-283. ISSN 1367-5788.
- [4] Fossen, T. I. *Handbook of Marine Craft Hydrodynamics and Motion Control*. John Wiley & Sons, Ltd. 2011. ISBN 978-1-119-99149-6.
- [5] Cockcroft, A. and Lameijer, J. *A Guide to the Collision Avoidance Rules*. Butterworth-Heinemann. 2012. ISBN 978-0-08-097170-4.
- [6] Lazarowska, A. A new deterministic approach in a decision support system for ships trajectory planning. *Expert Systems with Applications*. 2017, (71), 469-478. ISSN 0957-4174.
- [7] Dorigo, M. and Stützle, T. *Ant Colony Optimization*. MIT Press Massachusetts Institute of Technology. 2004. ISBN 978-0-262-04219-2.
- [8] Lazarowska, A. Ship's trajectory planning for collision avoidance at sea based on ant colony optimization. *Journal of Navigation*. 2015, (68), 291-307. ISSN 0373-4633.
- [9] Pozyx Labs Indoor Positioning System [online]. Belgium: Pozyx BVBA, 2018. [viewed date 4 June 2018]. Available from: <<https://www.pozyx.io>>
- [10] DFRobot Pirate-4WD mobile platform [online].China: DFRobot, 2018. [viewed date 4 June 2018]. Available from: <<https://www.dfrobot.com>>

THE ALGORITHM FOR FAST FORECASTING OF THE COLLISION DANGER DEGREE WITH SHIPS AND SURFACE OBJECTS IN THE E-NAVIGATION AREA

**ANATOLIY N. POPOV*, ALEXEY I. KONDRATIEV*
AND IGOR O. SMIRNOV***

*Admiral Ushakov Maritime State University
Lenina Avenue, 93, 353918 Novorossiysk, Russian Federation
e-mail: an.popov.mga@gmail.com, <https://www.aumsu.ru>
e-mail: kaikondr@gmail.com, <https://www.aumsu.ru>
e-mail: Zeherd@yandex.ru, <https://www.aumsu.ru>

Keywords: Algorithm, User interface, Augmented reality, E-Navigation

Summary. *The article contains the algorithm for fast forecasting of the collision danger degree conducted by a ship computer, which is an e-Navigation component. Further studies suggest forming a new user interface with the formation of augmented reality to accelerate and facilitate the navigator's decision as an element of the marine ergatic system.*

1 INTRODUCTION

One of the most important trends in the sphere of providing both safe and secure navigation at sea, taking into account the fast implementation of transport information technologies is the development of universal information space (UIS), which will give participants of technological process as well as experts the opportunity to interact in the real time framework. The current methodology of ships collision prevention does not completely meet the amended requirements of the safety Collision Regulations-72. Considering the tendency of unmanned ships in the water transport known as People Less Navigation (PLN) the importance of human element is increasing in the process of decision making. For the complex solution to the current problems on the improvement of the decision making process, while safe maneuvering and collision prevention, it is proposed to create «an intelligent water area» based on the key initiative implemented by IMO, namely e-Navigation concept [1]. The possibility of ship's maneuvering forecasting has become most topical during the search of the closed approach, forming a principally new user interface. It is crucial to take into consideration an increase in ships number and the speed of each participant of the transportation process. The functional particulars of the alarm system on the availability of the collision danger are still based on regular algorithms. These algorithms are reliable but sometimes not very efficient due to the fact that in some cases the number of active alarm

indicators on the bridge exceeds the ability of a navigator to percept and efficiently handle this information, while the appropriate maneuver choice.

The proposed algorithm for fast forecasting is intended for a ship computer with the use of software by the e-Navigation system. The collision danger degree is recalculated every second and visualization of fast forecasting is presented in 3 D format. As a result a navigator can observe the real picture of forecasting, which reduces the cognitive load as well as the time of decision making. The current user interface (ARPA, ECDIS) is of Head Down Display type and mainly focused on the Human Computer Interaction. In this case the navigator's temporary and cognitive abilities are used irrationally. Constant improvement of technologies gives an opportunity for the foundation of innovative paradigms of the user interface. The augmented reality (AR) technology allows to improve the navigator's interface in the Head Up Display format and carry out the transition to the improved interaction with the environment (Human Environment Interaction). The present research is an attempt to unite the abilities of artificial intelligence (algorithm of computer forecasting, including software in the C++ programming language) and the augmented reality technology (visualization of virtual information, including software in the C# programming language) in the marine ergatic system e-Navigation.

2 GENERAL SPECIFICATIONS

Considering the prominent technological development of the shipping industry in the perspective it is possible to further e-Navigation's development strategy and its limited connection with «an intelligent water area» concept as precise in the issues of the maritime safe navigation, including collision prevention, dangerous incidents, environmental protection and economic efficiency system. Forming «an intelligent water area» involves universal assessment and handling of the developing navigational communication information system as well as the complexes of ship and shore hierarchical infrastructure in the concept of e-Navigation framework. E- ships should be equipped with test ECDIS samples adapted to solving e-Navigation tasks. The development of the e-Navigation concept will make it possible to formalize Collision Regulation – 72 requirements and provide each navigator with a duly warning on the collision danger.

The technological systems with an automated process and decision support such as ARPA, AIS make it possible to select an alarm system for the dangerous situation. But it is a navigator who takes a decision and this situation can be characterized as the situation, which does not have a clear definition. Collision Regulation – 72, Rule 8 «Action to avoid Collision», states that the action taken to prevent collision with another ship should be carried out in such a way so as to provide a safe distance after the completion of the maneuvering [2]. For the duly assessment of a distance requirement for ships safe maneuvering and decision making regarding its danger or safety we offer below the solution to forecasting tasks between two ships in «an intelligent water area».

3 OBJECTIVE

While considering the steady ship motion of both ships, to determine the distance up to the target and its position, when the distance has the minimum value.

4 SOURCE DATA

Means of satellite navigation provide the current information about ship's movement every second and UIS concept being realized will allow delivering the information about traffic of all ships within e-Navigation «intelligent water area» to e-ship. NMEA protocol on information share with GPS/GLONASS transmitter determines the format of message, containing in particular:

- the current location of the transmitter (φ, λ) – latitude and longitude. They will be expressed in radians, where South latitude and Western longitude both have negative values;
- magnitude of velocity v and heading angle θ of moving transmitter;
- instant of time t , which the above mentioned values are related to.

The above mentioned values related to the e-ship will be marked by zero index: (φ_0, λ_0) , v_0 , θ_0 , t_0 . The unmarked clue will relate to the target. The collision possibility with this ship is subject for the investigation [3].

5 THE SYSTEMS OF COORDINATES

The projection of the location of the transmitter fitted in the e-ship to the water surface will be referred as mark-point of the ship. So the data (φ, λ) , v , θ , t describe the movement of the mark-point of the ship under consideration.

Three coordinate systems will be applied in the calculation.

- 1) geographical coordinates (φ, λ) of the target. It is a curve coordinate system.
- 2) Cartesian coordinate system $Ox'y'$ with the origin of coordinate system of e-ship, axis Ox' is directed towards the East, axis Oy' to the North. This coordinate system is located in the plane touching the water surface in the origin of the coordinate system. The transition from (φ, λ) to $Ox'y'$ is fulfilled by the map projection. In the calculations the isometric azimuthal Lambert projection is used [4]. If the projection center is considered beginning with the mark-point of the e-ship, this projection provides target bearing without any distortions as well as the distance to the target. Since we use this projection not for map drawing purposes, but for calculation, by using a sophisticated computer we have an opportunity to have the «map center» always at the mark-point of the e-ship.
- 3) Cartesian coordinate system Oxy with the origin at the mark-point of the e-ship, axis Oy is directed towards the ship's course; axis Ox is athwart to the course to the starboard side.

This coordinate system is available in the same plane. The transition from coordinates $Ox'y'$ to coordinates Oxy is realized by the rotation matrix

$$\mathbf{T} = \begin{pmatrix} \cos \theta_0 & -\sin \theta_0 \\ \sin \theta_0 & \cos \theta_0 \end{pmatrix}. \quad (1)$$

6 Illustrations

«Ideal ship's collision» («ideal» in mathematical sense) is presented by the coincidence of the mark-points of both ship at some definite moment of time. In coordinate $Ox'y'$ it is presented in figure 1.

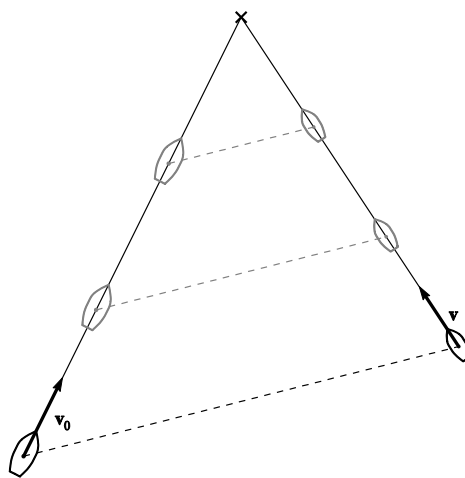

Figure 1. Collision of the ship with a constant target bearing in the coordinate system $Ox'y'$

That is why Collision Regulation – 72, Rule-7 «Risk of Collision» states:

- (i) such risk shall be deemed to exist if the compass bearing of an approaching vessel does not appreciably change;
- (ii) such risk may sometimes exist even when an appreciable bearing change is evident, particularly when approaching a very large vessel or a tow or when approaching a vessel at close range.

With constant bearing we have «ideal ship's collision» (in a mathematical sense). Under the small bearing deviation the minimal distance d_{\min} to the closest point of approach is miserably small. The value of d_{\min} may be determined best of all in the coordinate system Oxy moving along with e-ship (figure 2).

In this case the target velocity vector related to e-ship is not directed straight per bearing, so the target course line does not meet the mark-point of the e-ship.

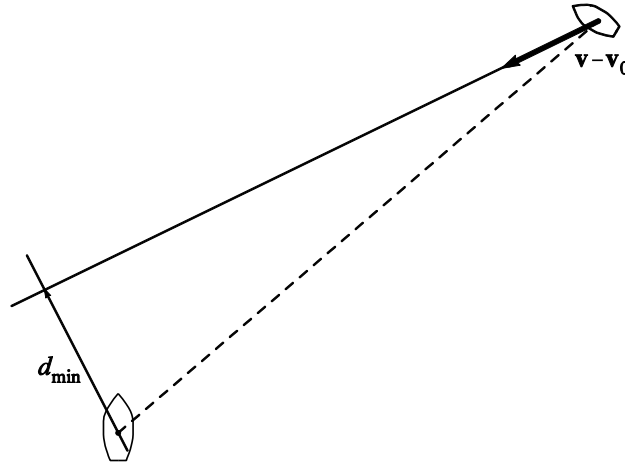

Figure 2. The minimal distance between ships determined in the coordinate system to e-ship

If d_{\min} is less than some critical value (which is subject for further determination), then we decide that such a movement of the ships is dangerous.

Note that the forecast for the value of d_{\min} may be based on single measurements only, no time is required for continuous observation of the target's bearing alteration.

7 TASK SOLVING

For the spherical Globe surface model the equations of Lambert's projection are given below (2).

$$k' = \sqrt{\frac{2}{1 + \sin \varphi_0 \sin \varphi + \cos \varphi_0 \cos \varphi \cos (\lambda - \lambda_0)}};$$

$$x' = R_G k' \cos \varphi \sin (\lambda - \lambda_0); \quad (2)$$

$$y' = R_G k' [\cos \varphi_0 \sin \varphi + \sin \varphi_0 \cos \varphi \cos (\lambda - \lambda_0)]$$

where R_G is the radius of the Globe.

The target vessel speed vector $(v \sin \theta, v \cos \theta)^T$ in (φ, λ) axis is presented by the formula $\frac{v}{R_G} \left(\frac{\sin \theta}{\cos \varphi}, \cos \theta \right)^T$. For the $Ox'y'$ system the same vector is represented as:

$$\begin{pmatrix} v_{x'} \\ v_{y'} \end{pmatrix} = \frac{v}{R_G} \cdot \mathbf{D} \cdot \begin{pmatrix} \sin \theta \\ \cos \varphi \\ \cos \theta \end{pmatrix},$$

where \mathbf{D} is the matrix of partial derivatives:

$$\mathbf{D} = \begin{pmatrix} \frac{\partial x'}{\partial \varphi} & \frac{\partial x'}{\partial \lambda} \\ \frac{\partial y'}{\partial \varphi} & \frac{\partial y'}{\partial \lambda} \end{pmatrix},$$

calculated at the point (φ, λ) in accordance with the above equations (2).

When we calculate the velocity vector, the Globe radius R_G is eliminated in equation, thus its value can be ignored (referred as 1).

Now we make a transition of the reference system into Oxy :

$$\begin{pmatrix} x \\ y \end{pmatrix} = \mathbf{T} \begin{pmatrix} x' \\ y' \end{pmatrix}, \quad (3)$$

where \mathbf{T} is a matrix for the origin rotation by the angle θ_0 , ref. (1).

Finally, the target vessel velocity vector in the relation to reference system Oxy moving along with e-ship is obtained by the subtraction of the e-ship's own velocity vector:

$$\begin{pmatrix} v_x \\ v_y \end{pmatrix} = \mathbf{T} \begin{pmatrix} v_{x'} \\ v_{y'} \end{pmatrix} - \begin{pmatrix} 0 \\ v_0 \end{pmatrix}, \quad (4)$$

As the sampling time for both systems may be different, the initial values are subject to be determined for the same initial time t_0 . According to the hypothesis of the steady ship motion the position of target ship at time t_0 is obtained as follows:

$$x^* = x - (t - t_0)v_x, \quad y^* = y - (t - t_0)v_y,$$

where x, y, v_x and v_y calculated by equations (3)–(4).

So, the ship's movement in the coordinate system Oxy is described by the parametric equations

$$\begin{cases} x(t) = x^* + t \cdot v_x, \\ y(t) = y^* + t \cdot v_y, \end{cases} \quad (5)$$

where t is the proposed time from the moment of observation t_0 . The trajectory line has an equation

$$Ax + By + C = 0,$$

where $A = v_y, B = -v_x, C = v_x y^* - v_y x^*$.

8 CONCLUSIONS

The target ship will cross the course line of the e-ship at the point $(0, \frac{C}{v_x})$. If $\frac{C}{v_x} > 0$ (C and v_x have the same sign) then the cross point will be ahead on the course, if $\frac{C}{v_x} < 0$ then cross point will be astern on the course. It will happen at the time moment $t = -\frac{x^*}{v_x}$. If $t > 0$ then the cross time is in the future relating the time of observation, if $t < 0$ then the cross time is in the past.

The target ship will cross the e-ship's abreast (that is perpendicular to the course line) at the point $(-\frac{C}{v_y}, 0)$. If $-\frac{C}{v_y} > 0$ (C и v_y have different signs) then the ship meets abreast on the starboard side, if $-\frac{C}{v_y} < 0$, on the port side. It will happen at the time moment $t = -\frac{y^*}{v_y}$. If $t > 0$ then the cross time is in the future relating to the time of observation, if $t < 0$, the cross time is in the past.

If $v_x x^* + v_y y^* \geq 0$ then the target ship moves away and is not in danger. Otherwise, the least distance to the target ship is equal to

$$d_{\min} = \frac{|C|}{\sqrt{A^2 + B^2}} = \frac{|v_y x^* - v_x y^*|}{\sqrt{v_x^2 + v_y^2}}.$$

It will happen at the moment $t_{\min} = -\frac{v_x x^* + v_y y^*}{v_x^2 + v_y^2} > 0$. The position of the least

distance in the coordinate system with the static origin (that is, the point on the water surface) may be obtained according to (5):

$$\begin{cases} x(t) = x^* + t_{\min} \cdot v_x, \\ y(t) = y^* + t_{\min} \cdot (v_y + v_0), \end{cases} \quad (6)$$

Further investigations involve the development of a new user interface (navigator, pilot, VTIS operator and others) for the visualization of the proposed solutions in the e-Navigation zone, without any control distraction for the real navigational situation (figure 3). The user interface in particular will be applied to mark potentially dangerous targets by special markers of the different colors (green – safe, yellow – attention, red – dangerous) attracting the navigator's attention during the decision making process [5, 6].

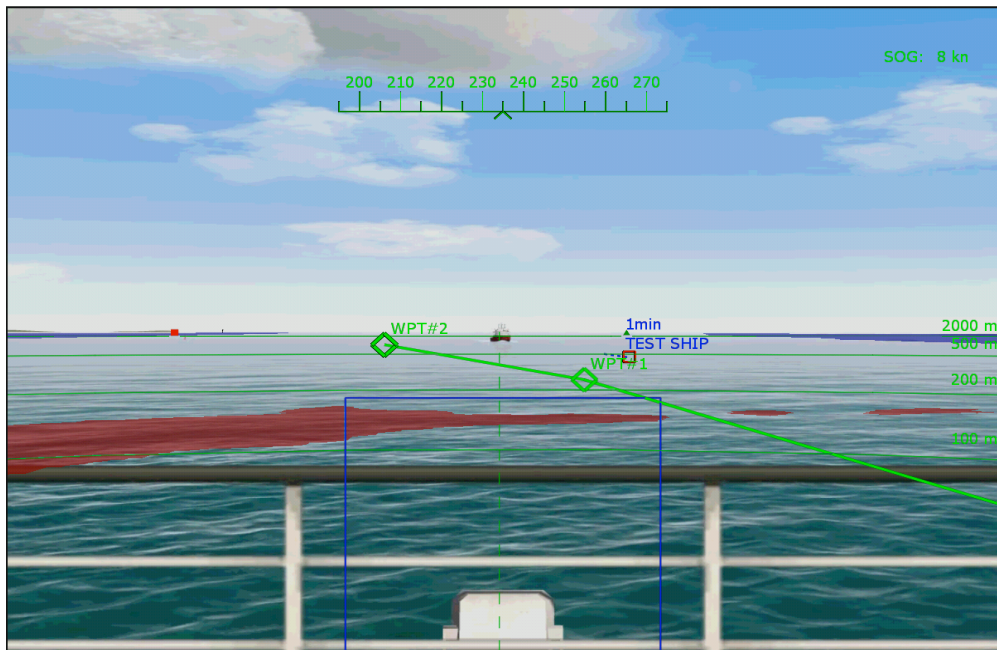

Figure 3. AR interface

REFERENCES

- [1] IMO. *International Maritime Organization* [online]. London: IMO, 2018 [viewed date 16 August 2018]. Available from: <<http://www.imo.org>>
- [2] Kondratiev, A. VLCC's collision avoidance action, while ship maneuvering with the use of PC, AUMSU, 2001
- [3] Baldauf, M. and others. Collision avoidance systems in air and maritime traffic. Proc. IMechE Part O. In: *Journal of Risk and Reliability*. Vol. 225 (3), 2011, pp. 333-343.
- [4] Semenov, I. Marine cartography: Morkniga, 1972
- [5] Burns, C.M. Hajdukiewicz J. Ecological interface design: Taylor & Francis, 2013
- [6] Hagen, J.E. Implementing e-Navigation, Artech House, 2017

THE APPLICATION OF MATHEMATICAL MODELS AND BRIDGE SIMULATIONS IN THE FEASIBILITY STUDY OF SHIP MANOEUVRING

T. SEN DO^{*†}, E. HIETBRINK^{*}, C. VINH TRAN[†]

^{*} Mathematical Modelling and Applied Research
Maritime Centers of Excellence (SIMWAVE)
Pesetastraat 7-9, 2991 XT, Barendrecht, The Netherlands
dothanhsen@gmail.com; ehietbrink@simwave.nl, web page: <https://www.simwave.nl>

[†] Ho Chi Minh City University of Transport (UT-HCM)
HH2, D3, Van Thanh Bac, Ward 25, Binh Thanh District, Ho Chi Minh City, Vietnam
dothanhsen@gmail.com, tcvinh1951@gmail.com; web page: <https://ut.edu.vn>

Keywords: Ship mathematical modelling, Ship manoeuvring, Bridge simulator.

Abstract: It is obvious that the development of modern bridge simulators nowadays provides an advanced tool for maritime training. Apart from the educational function, advanced simulators can, with the proper knowledge and tools, be exploited for the feasibility study of ship manoeuvring for existing ports, ships under operation as well as ships, ports and locks in the design phase. Thus, it is necessary to set up proper ship mathematical models and establish a scientific process for assessment of ship manoeuvring in simulators. This paper aims to systematically introduce mathematical modelling and proposes a method to assess the ship manoeuvring in six degrees of freedom and in real-time mode influenced by all possible forces on the vessel. The mathematical model and assessment method were used in applied research projects which have been conducted by the study group during the research period.

1 INTRODUCTION

The mathematical model of ship motions is considered as an artificial brain deciding the processing capability of a bridge simulation system and ensuring the reality of ship manoeuvring. It can be described as a set of differential equations based on Newton's equation. The factors of the equations are defined based on hydrostatic, hydrodynamic, aerodynamic theories and empirical data. Davidson and Schiff (1946) [1] set up a mathematical model for yawing and drifting in 2DOF. Nomoto (1957) [2] described a simple equation posted in Zosen Kiokai Journal. Norrbín (1971) [3], Inoue (1981) [4] and other researchers developed 3DOF model including surging, swaying, yawing. Eda (1980) [5], Hirano (1980) [6] and Oltmann (1993) [7] described 4 DOF model by adding the rolling motion. By adding heaving and pitching motions Ankudinov (1983) [8] and Hooft & Pieffers (1988) [9] established 6DOF model. A generalized mathematical model in 6 degrees of freedom in the form of a matrix can

be referred in Fossen (2011) [10]. Based on the mathematical model, a simulation algorithm is set up to stimulate the ship motion in the bridge simulators. In the past, it was mostly developed for 3DOF limited to surging, swaying, yawing. Nowadays, more degrees of freedom are integrated into the model, but in frequently applied methods some components are simplified, ignored or added separately from the main equation for making the additional effects to experience rolling, heaving and pitching. To develop a ship mathematical model, a modeller must manually calculate all necessary hydrodynamic and hydrostatic coefficients or design it based on the mathematical model tools created by the simulator manufactures. More advanced mathematical model tool for 6DOF can be referred to the Kongsberg's publication [11].

The idea is how to use a suitable mathematical model to simulate the ship motion in six degrees of freedom and in real-time mode with satisfying behaviour for the feasibility study of ship manoeuvrability. This paper aims to systemize a detailed mathematical model and propose a method for assessment of the ship manoeuvrability in simulators taking into account all possible internal and external forces.

2 MATHEMATICAL MODELLING

Fundamentally, a general equation describing the ship motions can be described in six degrees of freedom in the form of the matrix:

$$M_S \begin{bmatrix} \dot{u} \\ \dot{v} \\ \dot{w} \\ \dot{p} \\ \dot{q} \\ \dot{r} \end{bmatrix} + C_S(v) \begin{bmatrix} u \\ v \\ w \\ p \\ q \\ r \end{bmatrix} + M_A \begin{bmatrix} \dot{u} \\ \dot{v} \\ \dot{w} \\ \dot{p} \\ \dot{q} \\ \dot{r} \end{bmatrix} + C_A(v) \begin{bmatrix} u \\ v \\ w \\ p \\ q \\ r \end{bmatrix} + D(v) \begin{bmatrix} u \\ v \\ w \\ p \\ q \\ r \end{bmatrix} + g(\eta) = \begin{bmatrix} X \\ Y \\ Z \\ K \\ M \\ N \end{bmatrix} \quad (1)$$

Where, M_S and M_A are a generalized mass matrix of the ship and added masses; $C_S(v)$, $C_A(v)$ are Coriolis and centripetal matrixes of the ship and added masses; $D(v)$ is a damping matrix; $\dot{x} = v = [u, v, w, p, q, r]^T$ is velocity matrix, $\ddot{x} = \dot{v} = [\dot{u}, \dot{v}, \dot{w}, \dot{p}, \dot{q}, \dot{r}]^T$ is acceleration matrix; $g(\eta)$ is generalized gravitational/buoyancy forces and moments. $f = [X, Y, Z, K, M, N]^T$ is matrix of propulsion and external forces and moments affecting to the ship. To solve the equation (1), all the factors including M_S , M_A , $C_S(v)$, $C_A(v)$, $D(v)$, $g(\eta)$ and f must be defined in detail.

2.1. M_S , M_A , $C_S(v)$, $C_A(v)$

M_S is defined based on the ship's design and given loading condition.

$$M_S = \begin{bmatrix} m & 0 & 0 & 0 & mz_g & -my_g \\ 0 & m & 0 & -mz_g & 0 & mx_g \\ 0 & 0 & m & my_g & -mx_g & 0 \\ 0 & -mz_g & my_g & I_{xx} & -I_{xy} & -I_{xz} \\ -mz_g & 0 & -mx_g & -I_{yx} & I_{yy} & -I_{yz} \\ -my_g & mx_g & 0 & -I_{zx} & -I_{zy} & I_{zz} \end{bmatrix} \quad (2)$$

Where: m is the ship mass, $(x_g, y_g, -z_g)$ is the position of the ship's centre of gravity; I_{xx} , I_{yy} , I_{zz} are inertia moments and I_{xy} , I_{yx} , I_{xz} , I_{zx} , I_{zy} , I_{yz} are deviation moments of inertia

$$M_A = \begin{bmatrix} m_{11} & m_{12} & m_{13} & m_{14} & m_{15} & m_{16} \\ m_{21} & m_{22} & m_{23} & m_{24} & m_{25} & m_{26} \\ m_{31} & m_{32} & m_{33} & m_{34} & m_{35} & m_{36} \\ m_{41} & m_{42} & m_{43} & m_{44} & m_{45} & m_{46} \\ m_{51} & m_{52} & m_{53} & m_{54} & m_{55} & m_{56} \\ m_{61} & m_{62} & m_{63} & m_{64} & m_{65} & m_{66} \end{bmatrix} \quad (3)$$

M_A can be estimated by combining methods: assuming the ship wet hull as an elongated ellipsoid [12] and applying slender body strip theory with Lewis transformation mapping [13, 14]. Clarke typically applied this method for a flat plate and introduced an equation set for estimation of the added masses [15]. To reach maximum reality the authors suggest to use a combination method for estimating all the component m_{ij} of the M_A in [16]. The Coriolis forces $C_S(v)$ and $C_A(v)$ can be calculated based on the kinematics theory that was systemized in [10].

2.2. D(v)

The damping $D(v)$ consists of linear damping D and non-linear damping $D_n(v)$: $D(v) = D + D_n(v)$: D is formed due to potential damping and possible skin friction. $D_n(v)$ is created by the effect of “viscous fluid”. To estimate damping, empirical or semi-empirical formulas or simulation tests are applied. Cross-flow drag can be referred to the equations of Fedyevsky and Sobolev [17] in sway and yaw. Main empirical methods can be referred to the studies of Wagner Smitt, Norbin, Inoue, Clake [18], Lee [19], Kijima and Nakiri [20]. The authors suggest a method to estimate the damping by calculating the damping forces $d(v)$:

$$d(v) = D(v) \begin{bmatrix} u \\ v \\ w \\ p \\ q \\ r \end{bmatrix} = \begin{bmatrix} X_{LD} \\ Y_{LD} \\ Z_{LD} \\ K_{LD} \\ M_{LD} \\ N_{LD} \end{bmatrix} \quad (4)$$

$[X_{LD} Y_{LD} Z_{LD} K_{LD} M_{LD} N_{LD}]^T$ are damping forces due to drag and lift in 6DOF. Detailed calculation is presented in [21].

2.3. g(η)

$g(\eta)$ can be easily calculated based on the hydrostatic theory.

$$g(\eta) = \begin{bmatrix} -\rho g \int_0^z A_{wp}(\zeta) d\zeta \sin(\theta) \\ \rho g \int_0^z A_{wp}(\zeta) d\zeta \cos(\theta) \sin(\phi) \\ \rho g \int_0^z A_{wp}(\zeta) d\zeta \cos(\theta) \cos(\phi) \\ \rho g \nabla \overline{GM}_T \sin(\phi) \cos(\theta) \cos(\phi) \\ \rho g \nabla \overline{GM}_T \sin(\theta) \cos(\theta) \cos(\phi) \\ \rho g \nabla (-\overline{GM}_T \cos(\theta) + \overline{GM}_T) \sin(\phi) \sin(\theta) \end{bmatrix} \quad (5)$$

Where ρ is water density. $A_{wp}(\zeta)$ wetted area at waterline; ζ , θ , ϕ , ∇ , \overline{GM}_T are the heel angle, pitching angle, displacement and metacentric height.

2.4. Force f

In overview, the forces and moments affecting on the ship hull consist of:

- a) Propulsion forces: created by propellers and rudders.
- b) External forces: caused by the environmental effects including current, wind, wave, squat, bank suction, ship-to-ship interaction, mooring line, towing, tug support, anchor, collision, grounding.

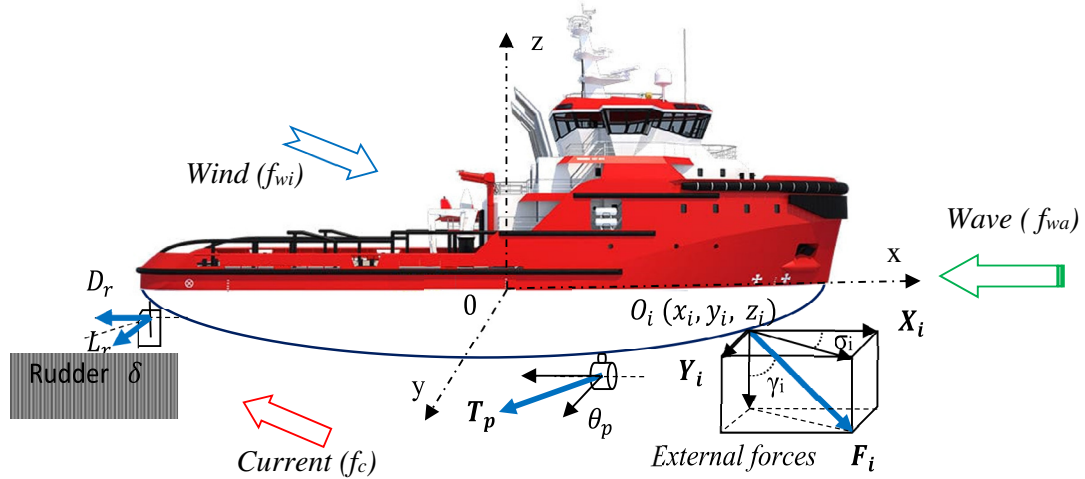

Figure 1: Description of components of a single i^{th} force

In practice, the force components are very complex and differ depending on the status of ship propulsion system, loading condition and environmental conditions.

While the ship is moving, all the forces are changing from time to time. Thus, in every real-time condition, a new status needs to be set up according to new parameters of affecting forces. This paper is introducing an aggregate force model applied to all components of force $\sum_{i=1}^n F_i$. Considering a single force F_i defined as the i^{th} force, σ_i as azimuth angle and γ_i as declination angle of the forces vector in a xyz frame from position O_i :

$$f_i = [X_i \quad Y_i \quad Z_i \quad K_i \quad M_i \quad N_i]^T; F_i = \sqrt{X_i^2 + Y_i^2 + Z_i^2} \quad (6)$$

The matrix of total forces and moments is described :

$$f = \sum_{i=1}^n \begin{bmatrix} X_i \\ Y_i \\ Z_i \\ K_i \\ M_i \\ N_i \end{bmatrix} = \sum_{i=1}^n F_i \begin{bmatrix} \cos(\sigma_i) \sin(\gamma_i) \\ \sin(\sigma_i) \sin(\gamma_i) \\ \cos(\gamma_i) \\ z_i \cdot (\sin(\sigma_i) \sin(\gamma_i)) \\ z_i \cos(\gamma_i) \\ y_i \cdot \cos(\sigma_i) \sin(\gamma_i) + x_i \cdot \sin(\sigma_i) \sin(\gamma_i) \end{bmatrix} \quad (7)$$

Where x_i, y_i, z_i are lever arms of the force F_i over axis OX, OY, OZ : $x_i = OX_i$; $y_i = OY_i$; $z_i = OZ_i$. With this calculation, all the forces can be considered as separate components $i^{\text{th}}, j^{\text{th}}, k^{\text{th}}$.

This enables to calculate and add single forces into the equations (1) in real-time simulation. Detailed calculation of a specific force can be referred to the posted researches.

2.5. Describing the ship's motion status in real-time mode

From the equation (1). The ship's acceleration can be described in 6DOF over the time :

$$\dot{v}(t) = \frac{1}{M_S + M_A} [f - g(\eta) - g_0 - (C_S(v) - C_A(v) - d_n(v))v(t)] \quad (8)$$

Thus, the velocity in 6DOF over the time in each degree of freedom can be obtained:

$$v(t) = v(0) + \dot{v}(t) \times dt \quad (9)$$

$$u(t) = u(0) + \dot{u}(t) \times dt \quad (10)$$

$$w(t) = w(0) + \dot{w}(t) \times dt \quad (11)$$

$$p(t) = p(0) + \dot{p}(t) \times dt \quad (12)$$

$$q(t) = q(0) + \dot{q}(t) \times dt \quad (13)$$

$$r(t) = r(0) + \dot{r}(t) \times dt \quad (14)$$

The position of the ship can be presented in the Descartes frame :

$$x(t) = x(0) + v(t) \times \cos(\psi - \beta)dt \quad (15)$$

$$y(t) = y(0) + u(t) \times \sin(\psi - \beta)dt \quad (16)$$

$$z(t) = z(0) + w(t) \times dt \quad (17)$$

The heel $\phi(t)$, trim $\theta(t)$, heading $\psi(t)$ and drift angle $\beta(t)$ described :

$$\phi(t) = \phi(0) + p(t) \times dt \quad (18)$$

$$\theta(t) = \theta(0) + q(t) \times dt \quad (19)$$

$$\psi(t) = \psi(0) + r(t) \times dt \quad (20)$$

$$\beta(t) = \frac{v(t)}{u(t)} \quad (21)$$

Based on the parameters determined as above, the status of the ship in 6DOF can be described over the time in the simulator in real-time mode.

3 APPLICATION OF MATHEMATICAL MODEL IN THE FEASIBILITY STUDY OF SHIP MANOEUVRING

With a full mathematical model as above given description, the ship can be simulated in a bridge simulator system if it is capable of handling this approach. The objectives can include:

- Feasibility study on manoeuvring of a vessel.
- Feasibility study on the design of ports/jetties.
- Feasibility study on the design of fairways.

Method of application for modelling and simulator assessment can be described by the following steps illustrated in Figure 2.

Step 1 - Ship model development: The ship mathematical and visual model is created. The mathematical modelling guarantees the correct behaviour of a ship including the characteristics of hydrodynamics, hydrostatics, aerodynamics, propulsion system, power management system, water ballast system, mooring, towing system and mechanical system. The visual model includes external visuals, internal visuals, wheelhouse, wet hull area of the vessel, radar geometry, collision geometry, navigation lights and deck light arrangement.

Step 2 - Area visual database development: This work creates the 3D-visual database of the navigation areas including fairway, TSS, depths, terminals, jetties, navigation light/buoy systems, landmarks and landscapes in the area. The reference data are based on WGS84 and in accordance with the last updated navigation charts and port design drawings.

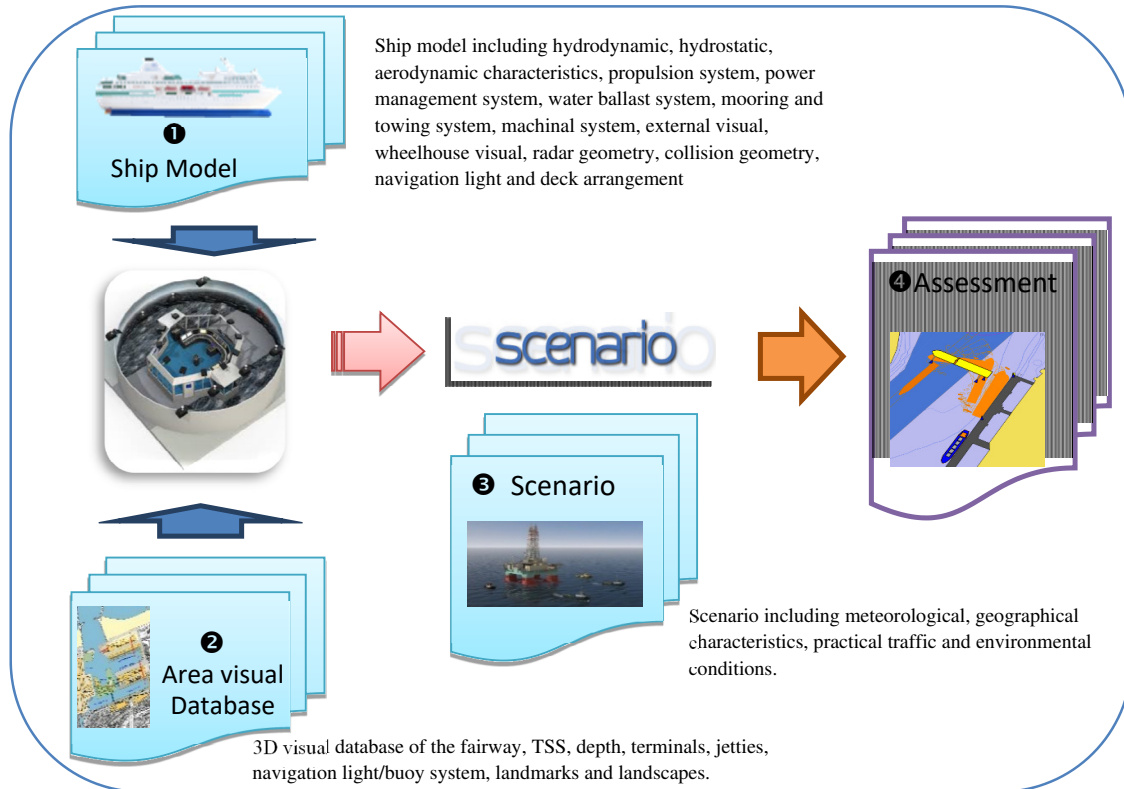

Figure 2: The process of the modelling and manoeuvrability assessment of a ship

Step 3 - Scenario development: This work involves creating scenarios for feasibility assessment on the simulator. In this step, traffic situations are built according to the requirements and objectives of the design. The meteorological, geographical characteristics, as well as practical traffic conditions, are included in the scenarios. If applicable storms, currents, wind, waves, tides, depths and other weather conditions such as rain, snow, ice, day or night are added to the scenarios.

Step 4 – Assessment: Based on the design and simulation development in step 1, 2 and 3, the scenarios will be run in the bridge simulator when applicable, under the observation and required assessment of navigators, pilots, tugboat captains, VTS’s operators, assessors and concerned parties. The output of the simulator runs, visual and digital figures recorded by and exported from the simulator system will be used for the final report which describes the detailed results of the feasibility study and can include advices on the ship, port, fairway design and safety measures.

4 PRACTICAL APPLICATIONS

During the duration from 2016 to 2018, the study group conducted several applied research projects with the application of the above-mentioned method and process. Facilities used for the researches included the Full mission bridge (FMB) simulator of the Ho Chi Minh City University of Transport (UT-HCM) and the advanced Kongsberg's K-Sim simulator platform of the Maritime Centres of Excellence (Simwave), the Netherlands. Simwave is the biggest and most advanced maritime simulator centre in the world located in Barendrecht, the Netherlands. The projects involved many experts and authorized personnel of related organizations.

Project 1: Feasibility study for the calling of 14,000 TEU container ship at Tancang-Caimep with FMB simulator (2016). This project was conducted at the request of Tancang Pilot in the simulator location of UT-HCMC. The 3D visual database for Tan Cang Caimep terminal and water area in Vung Tau and a specific 14,000 TEU container ship with several tugboats were modelled. The simulator test was conducted successfully and approved in December 2016.



Figure 3: Manoeuvring test of 14,000 TEU container ship at Tancang-Caimep

Project 2: An overall study of the fairway Vung Tau - Cai Mep – Thi Vai (2016). This project was funded by the Ministry of Transport (MOT) of Vietnam. The feasibility test was carried out in the bridge simulator system of the UT-HCMC. Apart from the visual database for the fairway, more than 20 ships of different real ocean and inland water vessels were modelled.



Figure 4: Simulator assessment on the new Vung Tau fairway and TSS

The project included a complex traffic separation scheme (TSS), which is the first introduced

in Vietnam, at the main connecting area of the fairways of Vung Tau, Sai Gon, Song Dinh and Thi Vai. The simulator test was conducted successfully and approved by MOT in October 2016.

Project 3: Feasibility study for calling of 18000 TEU container ship at CMIT port with FMB simulator. The Project was conducted at the request of Cai Mep International Terminal company (CMIT) and with the cooperation of Maersk Lines. The goal was to assess the ability for calling the supper large Maersk's Container ship 18,000TEU Triple-E at the CMIT port in Vung Tau, Vietnam. The ship mathematical model, area design and many scenarios with various environmental conditions and traffic situations were simulated according to the recommendations of the local maritime management organizations.



Figure 5: Assessment of the manoeuvring of Triple-E ship

The simulation test was conducted by experienced captains of Maersk Lines, Vungtau pilots, Pilotco 1, Haivan Tugboat company with the supervision of Vietnam Maritime administration, Vungtau port authority, Vungtau VTS, Southern Maritime Safety Corporation. The project was approved by the authorized parties in December 2016.

Project 4: Real-time simulations regarding safe berthing and unberthing of a completely newly designed bulk carrier sailing from and to the Port of Conakry in Guinea, Africa (2018). This is a special project requested by Concordia, the Netherlands to model a ship in the design stage. This is a new design and the port is also under construction. A new ship model and a 3D visual database of the port were developed.



Figure 6: New ship design and Port of Conakry deployed in Kongsberg platform

The final test on February 2018 showed that the mathematical model and visual design were satisfactory. This outcome supports the theory that the method can be applied to ships and areas under design stage.

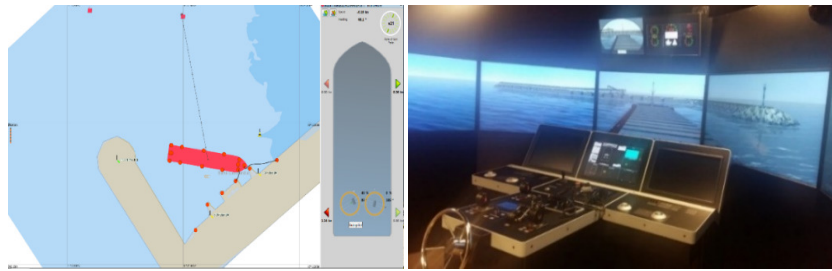

Figure 7: Manoeuvring test of the newly designed ship on Simwave's bridge simulator

5 CONCLUSION

With the application of the mathematical modelling, the assessment of ship manoeuvrability can be done in a high-end bridge simulator. This paper systemizes and introduces a combinative method to establish a complete mathematical model describing the full 6DOF of ship motions in real-time mode with the detailed formulas to calculate hydrostatic, hydrodynamic coefficients and the generalized formula describing all forces and moments of the propulsion systems and the environmental effects including current, wave, wind, shallow water and other external forces. Thus, the method improves the missing or limitation of the mathematical models in existing simulator systems by adding all components of the differential equation in 6DOF. The approach of this study is also based on theoretical formulas which are faster and easier for digitalizing and computing in a simulator system and can be applied for modelling a ship in the design stage. Moreover, the paper also suggests a procedure to set up the necessary work of the testing process for the existing bridge simulators including ship mathematical and visual model, port and fairway visual databases and scenarios.

6 ACKNOWLEDGEMENT

This study was facilitated by UT-HCMC and The Maritime Centres of Excellence (SIMWAVE), The Netherlands. UT-HCMC and SIMWAVE did provide necessary simulation facilities and support for this research. We would like to express our sincere thanks to the support and cooperation of the involved organizations and individuals who participated in specific researches, assessments and consultancy to make the above projects completed and approved.

REFERENCE

- [1] AVIDSON, K.S.M. and L.J. SCHIFF, *Turning and Course-Keeping Qualities*. Society of Naval Architects and Marine Engineer, New York NY, 1946.
- [2] Kiokai, J.o.Z., *On the steering qualities of ships*. Journal of Zosen Kiokai, 1957. 1956 (1956)(99): p. 75-82.
- [3] Norrbin, N., *Theory and observations on the use of a mathematical model for ship manoeuvring in deep and coned water*. 1971, Swedish State Shipbuilding Experimental Tank, Technical Report 63.: Gothenburg.

- [4] S., I., et al., *A practical calculation method of ship manoeuvring motion*. International Shipbuilding Progress, 1981. 28, No. 325: p. 207-225.
- [5] Eda, H., *Maneuvering performance of high-speed ships with effect of roll motion*. Ocean Engineering, 1980. 7(3): p. 379-397.
- [6] HIRANO, M., *A Practical Calculation Method of Ship Maneuvering Motion at Initial Design Stage*. the Society of Naval Architects of Japan, 1980. 147: p. 68-80.
- [7] P., O. *Roll – An often neglected element of manoeuvring*, *Proceedings*. in *International conference on Maritime Simulation and Ship Manoeuvrability MARSIM '93*. 1993. St. John's, Newfoundland, Canada.
- [8] Ankudinov, V.K. *Simulation Analysis of Ship Motion in waves*. in *International Workshop on Ship and Platform Motions*. 1983. University of California at Berkeley.
- [9] Hooft, J.P. and J.B.M. Pieffers, *Manoeuvrability of frigates in waves*. Marine Technology, 1998. 25(4): p. 262-271.
- [10] FOSSEN, T.I., *Handbook of Marine Craft Hydrodynamics and Motion Control*. 2011, Norway: Norwegian University of Science and Technology Trondheim, John Wiley & Sons.
- [11] Zaikov, S. and D. Nikushchenko, *Mathematical Model of Ship Dynamics*. 2016: Kongsberg Maritime.
- [12] KOROTKIN, A.I., *Added Masses of Ship Structure*. Marine Technology, 1988. 25: p. 262-271.
- [13] KORNEV, N., *Lectures on ship manoeuvrability*. 2013: Rostock University.
- [14] JOURNÉE, M.J. and J.M.J. ADEGEEST, *Theoretical Manual of Strip Theory Program "SEAWAY for Windows"*. 2003, the Netherlands.: Delft University of Technology.
- [15] Clarke, D., *A two-dimensional strip method for surface ship hull derivatives: comparison of theory with experiments on a segmented tanker model*. Journal of Mechanical Engineering Science 1959-1982, 1972. 1-23.
- [16] Sen, D.T. and T.C. Vinh. *Determining Hydrodynamic Coefficients of Surface Marine Crafts*. in *International Conference on Maritime Science and Technology 2016 (IAMU AGA17)*. 2016 Hai Phong: Vimar.
- [17] SOBOLEV, G.V. and K.K. FEDYAYEVSKY, *Control and Stability in Ship Design*. 1964, Washington DC: Translation of US Dept. of Commerce.
- [18] P., C.D., H. G., and G. P., *The Application of Manoeuvring Criteria in Hull Design Using Linear Theory*. The Royal Institution of Naval Architects, 1982.
- [19] Lee, T.I., *On an Empirical Prediction of Hydrodynamic Coefficients for Modern Ship Hulls*. MARSIM'03, 2003.
- [20] Katsuro Kijima, Y.N., *On the Practical Prediction Method for Ship Manoeuvring Characteristics*.
- [21] Sen, D.T. and T.C. Vinh. *Mathematically estimating hull resistance forces of ships in six degrees of freedom*. in *The 16th Annual Conference of the Asia Maritime & Fisheries Universities Forum (AMFUF 2017)*. 2017. Ho Chi Minh city.

AUTHORS INDEX

| | | | |
|-----------------------------|---------------|----------------------------|----------|
| Abdel Aziz, M. E. | 270 | Jensen, T.E. | 71 |
| Abdel Hamid Kassar, A. | 79 | Johansson, E. | 407 |
| Akmad, S. | 113 | Kamahara, J. | 21 |
| Albayrak, T. | 305 | Kamga, C. | 407 |
| Alfultis, M. | 87 | Kirchhoff, M. | 94 |
| Allard, R. | 150 | Kondratiev, A.I. | 442 |
| Almalt, A. | 79 | Koseoglu, B. | 425 |
| Anh Tuan, V. | 382 | Kunieda, Y. | 215 |
| Asyali, E. | 150, 165 | Lazarowska, A. | 434 |
| Balasanyan, A. | 329 | Le Thi , H.G. | 222 |
| Baldauf, M. | 94 | Llull, T. | 296 |
| Barahona, C. | 320 | Lokuketagoda, G. | 207 |
| Baylon, A. | 189 | Maglić, L. | 137 |
| Benedict, K. | 94 | Mai Khanh, P. | 382 |
| Bezhanovi, Z. | 54 | Martín, A. | 296 |
| Bolmsten, J. | 21 | Martínez de Osés, X. | 296, 398 |
| Borén, C. | 416 | Mednikarov, B. | 344 |
| Bosch, R. | 61, 372 | Melliza, C. M. | 259 |
| Brčić, D. | 121 | Meyler, L.E. | 335 |
| Casals-Torrens, P. | 61, 372 | Mikeladze, T. | 54 |
| Casiano, G. A. C. | 259 | Miwa, T. | 207 |
| Castells, M. | 296, 320, 416 | Miyusov, M. | 173 |
| Catalayban, H. P. T. | 259 | Mogensen, J. | 158 |
| Celic, J. | 21 | Monastyrskaya, J. | 129 |
| Chen, Qi | 199 | Monastyrskaya, O. | 129 |
| Chesnokova, M. | 129 | Morsy, A. M. | 270 |
| Cole, S.J. | 165 | Moyseenko, S.S. | 335 |
| Colom-Cobb, J. | 352 | Mujal-Colilles, A. | 296 |
| Cossen, P.M. | 29 | Murai, K. | 215 |
| Cote, M.A. | 181 | Murcia Gonzalez, J.C. | 231 |
| Dai An, N. | 363 | Nadolny, W. | 145 |
| De Guzman, G. | 113 | Negapatan, L. | 113 |
| de Melo Rodríguez, G. | 231 | Nguyen Thi , T.N. | 222 |
| Deniz, C. | 37 | Nicolas, J. | 61 |
| Dimitrov, N. | 344 | Odintsov, V. | 242 |
| Do, T.S. | 450 | Ordás, S. | 320 |
| Duc Hanh, N. | 363 | Ozdemir, P. | 305 |
| Duong Nam, N. | 382 | Oñate, E. | 352 |
| Díaz-Gonzalez, F. | 61 | Parreño, R. M. M. | 259 |
| Eselmy, A. S. | 270 | Pedregosa, D.A. | 113 |
| Frančić, V. | 121, 137 | Phan, C.A.T. | 390 |
| Fuses, V. | 61 | Phan, V.Q. | 390 |
| García-Espinosa, J. | 352 | Phutkaradze, Z. | 329 |
| Gehrke, M. | 94 | Popov, A.N. | 442 |
| Gironella, X. | 296 | Ranmuthugala, D. | 207 |
| Glazkov , D. | 242 | Resnes, T. | 71 |
| Gluch, M. | 94 | Rodinadze, S. | 54 |
| Grifoll, M. | 416 | Rooks, M. J. | 46 |
| Guan, C. | 279, 407 | Roos, N.M. | 314 |
| Gueraçague, R. P. | 231 | Rudan, I. | 137 |
| Hietbrink, E. | 450 | Sakar, C. | 425 |
| Jayasinghe, S. | 207 | Santos, E. | 189 |

| | |
|----------------------------|----------|
| Schaub, M. | 94 |
| Serrano-Fontova, A. | 372 |
| Serván-Camas, B. | 352 |
| Siwe, U. | 398 |
| Smirnov, I.O. | 442 |
| Sodolski, B.D. | 113 |
| Svilicic, B. | 21 |
| Sviridyuk , N. | 242 |
| Sánchez-Arcilla, A. | 296 |
| Thanh Son, N. | 250, 288 |
| The Nam, T. | 382 |
| Thi Huong Giang, L. | 250 |
| Thi The Nguyen, N. | 250 |
| Torralbo, J. | 320 |
| Toz, A.C. | 425 |
| Tran, C.V. | 450 |
| Tuschling, G. | 94 |
| Valčić, S. | 121 |
| Van Uy, D. | 363 |
| Vasilev, V. | 344 |
| Vecendario, V. L. | 259 |
| Velasquez Correa, S. | 398 |
| Vu, N.K. | 390 |
| Yahalom, S. | 279, 407 |
| Yamagishi, T. | 215 |
| Yang, A. | 46 |
| Zakharchenko, V. | 173 |
| Zarbazoaia, K. | 54 |
| Zec, D. | 137 |
| Zincir, B. | 37 |
| de Melo Rodríguez, G. | 231 |
| Žuškin, S. | 121 |



UPC

UNIVERSITAT POLITÈCNICA DE CATALUNYA
BARCELONATECH
Facultat de Nàutica de Barcelona

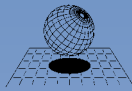

CIMNE

International Center
for Numerical Methods in Engineering